

EX LIBRIS









# The Una-Flow Steam-Engine

By

Prof. Dr.-Ing. h. c. J. Stumpf

Technische Hochschule, Berlin.

Translated by the

Stumpf Una-Flow Engine Company, Inc.,  
401 S. A. & K. Building.  
Syracuse N. Y.

Second Edition



1922

TJ492  
S7  
1922



# THE BATTLE OF THE ELEMENTS

By J. A. STUMPF.

(Chaos 1831, Nr. 5.)

God saw what he had made and found it good,  
Thus wrote a man of noblest mind and mood.  
No longer with this doctrine is the world content,  
The doubter does in bitter words lament:  
One need but cast a fleeting glance at life,  
What sees one there? True happiness? No, strife,  
Death, need and misery far and wide,  
The elements in constant war abide,  
And storms of passion breeding endless hate  
Rob life of peace, till many curse at fate.

We ask ourselves why we are so surrounded  
By raw materials and forces of all kinds,  
On what the longing in our breasts is founded,  
United with the curious impulse of our minds?  
As master of the earth, man shall create!  
All labor does the builder's hand await.  
To carry out His plan, God made him wise,  
That he might force and matter utilize.  
Such is the man whose work success has crowned,  
Who truth and light by his research has found,  
Who tested fire's flame and water's might,  
And thus their deepest secrets brought to light;  
Who through their elemental strife conceived,  
Instead of ruin, mankind's gain achieved.

Nature's forces he has sought,  
And under his control has brought.  
The foes who storm with rage and hate,  
He keeps by thin walls separate.  
Around the boiler roars the flame,  
The seething waves within to tame,  
Who, in revenge, their enemy to reach,  
Strive through the prison's walls to force a breach.

A polished rod ascends, by magic trained,  
Propelled by steam within a pipe contained.  
But lo! into the angry steam so bold,  
Now pours a rage-appeasing flood of cold;  
Down slides the rod, but in an instant back  
Pursued again by live steam in its track.  
The shining steel glides to and fro  
And, driving other parts, all show  
A striving to one goal. The great machine  
Obeys the master's mind, it may be seen.

How many nature's wondrous course deride,  
And what they do not grasp, they claim unproved,  
The man of science does regard with pride  
How parts and whole in best accord are moved.



## ERRATA

Page	Line or Fig.	Change from	To
70-71	Fig. 1	Max. Continuous L.H.P.	Max. Cont. I.H.P.
124	Line 17	Omit—"& T. Hall"	—
125	Heading	Omit—"& Hall"	—
125	Curve	Corliss	Counterflow
206	Last line	Lead	Load
234	Line 11	Fig. 14	Fig. 13
234-235	Fig. 13	German State Rys.	Russian State Rys.
303	Title	Omit "Triple speed"	

## TABLE OF CONVERSION FACTORS

1 mm.	=	0.039 in.
1 cm.	=	0.394 in.
1 m.	=	3.28 ft.
1 km.	=	1.609 miles
1 sq. cm.	=	0.155 sq. in.
1 sq. m.	=	10.76 sq. ft.
1 kg.	=	2.205 lbs.
1 metric ton	=	2204.6 lbs.
1 metric ton-km.	=	0.685 ton-mile
1 m. kg.	=	7.233 ft. lbs.
1 kg. per sq. cm. }		
1 atmosphere }	=	14.22 lbs. per sq. in.
1 metric H.P. }	=	0.9863 H.P.
1° C.	=	1.8° F.
Temp. in ° F.	=	1.8 × temp. in °C. + 32
1 calorie	=	3.968 B.T.U.
1 cal. per kg.	=	1.80 B.T.U. per lb.
1 cal. per I.H.P. hr. (metric)	=	4.024 B.T.U. per I.H.P. hr.
1 kg. per I.H.P. hr. (metric)	=	2.236 lbs. per I.H.P. hr.

## GENERAL INDEX

### A

Acceleration, valve, 88, 308  
Admission, 14 to 16  
A. E. G., 69  
Area, inlet valve, 50 to 58  
Area, exhaust port, 60, 69  
Auxiliary exhaust valves, 46, 47, 167, 177,  
208, 225, 264

### B

Balancing, 72, 297  
Bearings, proportions of, 73  
Belt, exhaust, 12, 69  
Blast, 112, 248  
Bleeding, 187  
    automatic control for, 190  
Bonnet, valve, Lentz, 87  
    Stumpf, 128

### C

Cage, valve, 2, 80, 170  
Cam  
    oscillating, 89, 143, 144, 164, 167, 170,  
    172, 206, 246, 264, 270  
    reciprocating, 128, 160, 208, 217, 231,  
    257, 277, 279, 287, 291, 292  
    revolving tapered, 208, 218, 297, 300  
    revolving stepped, 271, 293, 294  
Compounding, 2, 5, 190, 194  
Compression, best length of, 17 to 34  
Compressor, 218  
    combined steam and air cylinder, 213  
Condensation, initial, 1  
Condenser, 68  
    jet, 69  
    surface, 276, 294  
    Westinghouse-Leblanc, 69  
Condensing engine, 68, 126  
Connecting rod, 173, 264  
Consumption, steam,  
    lowest for various compressions, 17  
    to 26  
    lowest for various clearances, 27 to  
    29  
Convection, losses due to, 105  
Corliss una-flow engine, 182  
Crank, 74, 75  
    center, 71, 132  
Crank pin, proportions of, 73  
Crosshead, 171, 294  
    pin, proportions of, 73  
Cut-off, range of, 126  
Cylinder, boring of, 93, 155  
    material of, 92

### D

Diagram, indicator, 166, 175, 203, 269, 286  
Diffusor, 109, 110, 249  
Doerfel, 172  
Draft, smoke box, 112, 113, 248  
Drop, pressure, 51  
Dual clearance, 177

### E

Eccentric gear, single, 150  
Efficiency, mechanical, 71

### Engines

Ames Iron Works, 160, 161  
    automotive, 272  
    blowing, 213, 223  
Borsig, A., 245  
Burmeister & Wain, 132, 137, 278  
    compressor, 213, 218  
Corliss una-flow, 182  
Dehne, A. L. G., 218  
Ehrhardt & Schmer, 137, 139, 143,  
195, 196, 202  
Elsaessische Maschinenfabrik, 129  
Erste Bruenner Maschinenfabrik,  
129, 262  
Filer & Stowell Co., 178, 181  
Frerichs & Co., J., 273  
Goerlitzer Maschinenbauanstalt, 144  
Gutehoffnungshuette, 209  
Harrisburg Fdy. & Mch. Works, 177,  
178  
    hoisting, 207  
    Hungarian State Rys., 264  
    Kingsford Fdy. & Mch. Works, 292  
    Kolomna Engine Works, 225, 234, 237,  
    238, 262  
Linke Hoffmann Works, 218  
List, Gustav, 213  
Locomotive, 225  
Marine, 272  
Maschinenbauanstalt Breslau, 232  
Maschinenfabrik Augsburg-Nuern-  
berg (M. A. N.), 144  
Maschinenfabrik Badenia, 252, 255  
Maschinenfabrik Esslingen, 155  
Mesta Machine Company, 206, 223  
Musgrave & Sons, Ltd., 143  
Neuruppin-Kremmen-Wittstock Ry.,  
240  
Nordberg Mfg. Co., 172, 177  
Northeastern Ry. of England, 240  
Northern Ry. of France, 234  
    portable, 252  
    pumping, 213, 218  
Robey & Co., 262  
Rolling mill, 139, 195  
Schmid, Karl, 294  
Schweizerische Lokomotivfabrik, 232  
Skinner Engine Co., 168 to 171  
Soumy Machine Works, 159  
stationary, 127  
Stork & Co., 144  
Sulzer Bros., 10, 76, 150, 151, 155  
Vulkan Engine Works, 225, 227, 240,  
274  
Worthington Pump & Mch. Corp.,  
218  
Ejector effect, 110, 112 to 117, 245, 249,  
250, 269  
    saving due to, 117  
Expansion, cylinder, 128  
Experiments, Prof. Naegel's, 118 to 124

## F

- Friction
  - of driving parts, 77
  - H.P., 75-77
  - loss due to, 71

## G

- Gear
  - single eccentric, 150
  - valve, cam (locomotive), 230, 245
  - double-speed, 295, 303
  - Gooch, 207
  - Klug, 275, 278, 280, 290
  - link, disadvantage of, 16
  - Marshall, 237
  - Saeuberlich, 274
  - Skinner auxiliary exhaust, 171
  - Stumpf, 128, 129
  - Walschaert, 22, 230, 247, 285
  - Zvonicek, 143, 195
- Governor, flywheel, 252
- Gueldner, 110

## I

- Inertia, curves of, 72
- Insulation, 105

## J

- Jacketing, 27
  - effect of, 2, 3, 6, 10, 11, 12, 33
  - Sulzer's tests on, 11
- Jackets, proportions of, 12
- Joints, piston ring, 94, 95

## L

- Lagging, 105
- Lap, 128, 202, 207, 240
- Lead, exhaust, 5, 61, 108, 239, 269
- Leakage
  - losses due to, 79
  - valve, effect of, 85
- Lentz packing, 100
- Liner, 160
- Locomotive, 252
- Locomotive, 225
  - Borsig, 245
  - Kolomna Engine Works, 225, 234, 237, 238
  - Maschinenbauanstalt Breslau, 232
  - Neuruppin-Kremmen-Wittstock Ry., 240
  - Northeastern Ry. of England, 240
  - Northern Ry. of France, 234
  - Schweizerische Lokomotivfabrik, 232
  - Vulkan Engine Works, 225, 227, 240
- pistons for, 99
- three cylinder, 116, 240

## Losses

- friction, 71
- incomplete expansion, 108
- leakage, 79
- radiation and convection, 105
- surface, 1, 4
- throttling, 49
- volume, 13

## Lubrication

- cylinder, 99, 155, 227, 248, 273
- driving parts, 78
- valve gear, 87, 128

## M

### Machining

- of clearance surfaces, 2
- of cylinders, 93, 155
- of pistons, 93

### Marine engines

- Burmeister & Wain, 278
- Frerichs, & Co, J, 273
- Kingsford Fdy. & Mch. Works, 292
- Schmid, Karl, 294
- Vulkan Engine Works, 274

## N

- Nagel's experiments, 118 to 124
- Nozzle, 109, 116, 249, 269

## P

### Parts

- driving, proportions of, 71, 73, 75, 76
- reciprocating, 71, 72

### Packing, piston rod, 100 to 104

### Pin

- crank, proportions of, 73
- crosshead, proportions of, 73

### Pipe

- blast, 111, 112, 115, 248, 249
- exhaust, 109, 110
- steam, 105

### Piston

- cast steel, 78, 227
- expansion of, 93
- floating, 77, 92 to 94, 99, 155
- machining of, 93, 155, 227
- overrunning of, 94
- radial clearance of, 93, 155
- self-supporting, 77, 92, 155
- shoes, 77, 92, 155, 240
- three-piece, 227
- two-piece, 77, 240, 264

### Portable engines

- Erste Bruenner Maschinenfabrik, 262
- Hungarian State Rys., 264
- Kolomna Engine Works, 262
- Maschinenfabrik Badenia, 252, 255

### Ports, exhaust, 5, 69

- area of, 60, 113

### Pressure, back, 29 to 33, 42

- critical, 34 to 43

### Pump, tube, 223

### Pumping engines

- List, Gustav, 213
- Worthington Pump & Mch. Corp., 218

## R

- Radiation, losses due to, 105
- Rating, load, 71
- Relief, compression, for starting, 203, 207, 229, 230, 240, 247, 275
- Resilient valve, calculation of, 81
- Rings
  - piston, 94
    - hammered, 96
    - overrunning of, 97, 98
    - proportions of, 96
    - wear of, 98
- Rod, connecting, 72, 173, 263
  - tail, 77, 93, 206
- Rolling mill engines
  - Ehrhardt & Sehmer, 195, 196, 202
  - Mesta Machine Co., 206

## S

- Schlick, 297
- Seats, valve, 80, 85, 86
- Separators, oil, 69
- Series arrangement of parts, 85
- Shaft, crank, proportions of, 73
- Shoes, piston, 77, 92, 155, 240
- Slap, piston, 94
- Speed, piston, 71
- Stack, smoke, 112
- Stationary engines
  - Ames Iron Works, 160, 161
  - Burmeister & Wain, 132, 137
  - Ehrhardt & Sehmer, 137, 143
  - Elsassische Maschinenfabrik, 129
  - Erste Brunner Maschinenfabrik, 129
  - Filer & Stowell Co., 178, 181
  - Gorlitzer Maschinenbauanstalt, 144
  - Harrisburg Fdy. & Mch. Works, 177, 178
  - Maschinenfabrik Augsburg-Nurnberg, 144
  - Maschinenfabrik Esslingen, 155
  - Musgrave & Sons, Ltd., 143
  - Nordberg Mfg. Co., 172, 177
  - Skinner Engine Co., 168 to 171
  - Soumy Machine Works, 159
  - Stork & Co., 144
  - Sulzer Bros., 10, 76, 150, 151, 155

- Stepped cams, 271, 293, 294
- Stodola, 110
- Strahl, 112
- Superheater, 258
- Superheating, effect of, 2, 3, 5, 8, 273
- Surface clearance, 1 to 3, 7
- Surface clearance, minimum, 1

## T

- Temperature
  - steam, experiments on, 118 to 124
  - high, 8
- Tests, engine, 129, 137, 144, 157, 161, 234, 236, 265
- Throttling, losses due to, 49
- Tube pump, 203

## V

- Vacuum, high, 68
- Valves
  - clearance, 45, 46
  - Corliss, 79, 183 to 186
  - double beat, leakage, of, 79
    - locomotive, 230
    - resilient, calculation of, 81
    - tightness of, 79, 80
    - two-piece, 168
  - exhaust, auxiliary, 46, 47, 166, 167, 177, 208, 225, 264
    - automatic, 166, 264
  - inlet, area of, 50 to 58
    - leakage of, 85
  - piston, 79, 177, 178, 196, 210, 239, 240, 275
  - single beat, 86, 245, 247, 262, 272, 295, 303
  - slide, 79
    - locomotive, 237
- Valve spring, calculation of, 88, 308
- Volume
  - clearance, additional, 44 to 46, 126
  - clearance, % of, 48, 126, 127, 228

## W

- Walschaert gear, 22, 230, 247, 285
- Westinghouse-Leblanc, 69

## Z

- Zeuner, 111
- Zvonicek gear, 143, 195

## Preface.

The second edition of this book represents a complete revision of the first one, little of which remains. The first edition contained a good many opinions in addition to facts and was intended rather for the purpose of defending the una-flow engine against antiquated theories and attacks. In the meantime the una-

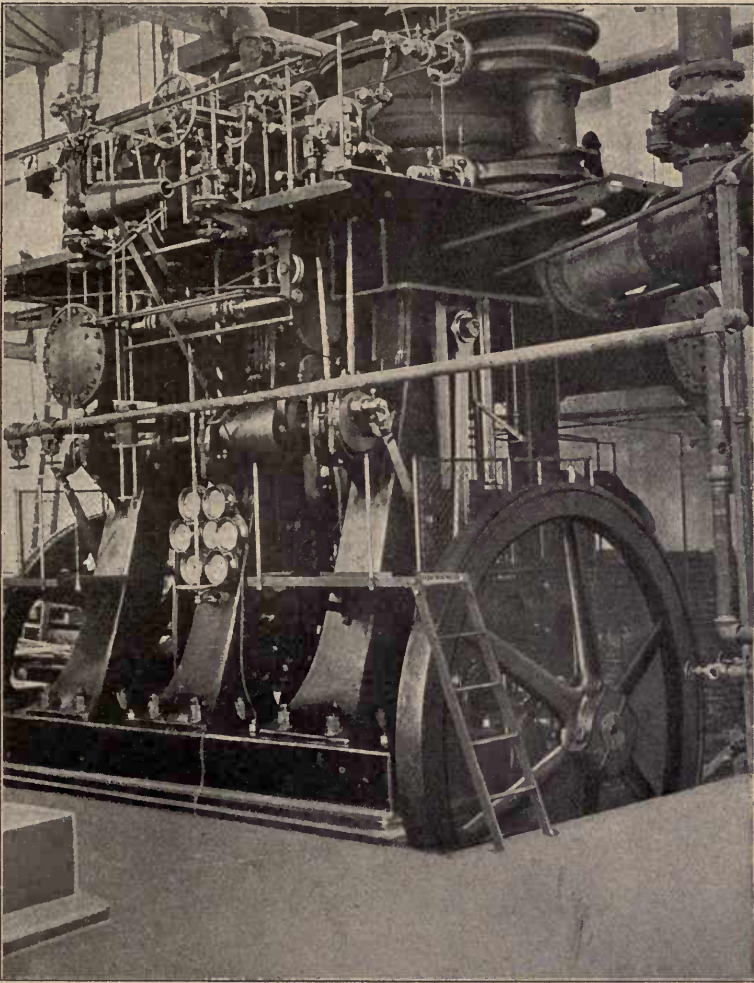


Fig. 1.

flow principle has been widely tried out and scientifically investigated. It has become an accomplished fact and is in common use. This book therefore contains scientific proof from an objective point of view, as well as a description of the development of the una-flow engine.

In the opening chapters of the book the different losses of the steam engine are investigated. The causes and effects are defined, as well as the relations between them, and the manner is pointed out in which the minimum value of each loss is obtainable. After considering all the seven different losses occurring in a steam engine, the question is asked as to how a steam engine must be designed in order to have a minimum total of all the seven losses. In answer to this query two different designs are presented, one being a stationary una-flow engine with single-beat valves for condensing operation, and the other a una-flow locomotive also equipped with single-beat valves. On the former, the use of single-beat valves was made possible by the use of a double speed valve gear (see Chapter VI).

Both types of engines were developed during the year 1920. Lower steam consumption figures than those given by the best multi-stage engines are

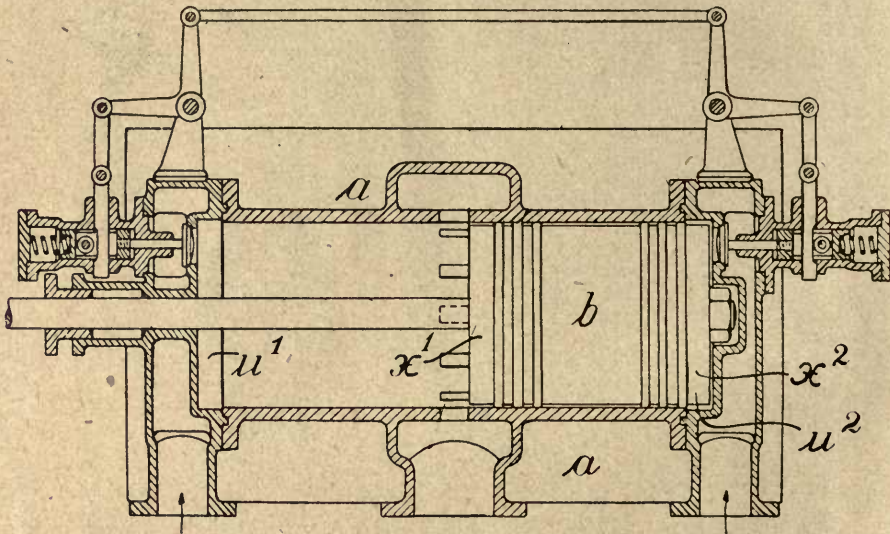


Fig. 2.

obtainable with these types for both saturated and superheated steam. The experience gained with una-flow engines in widely different fields and under the most varying conditions was utilized in the design of these engines to the fullest possible extent.

A number of Chapters is devoted to the description of this development in all its phases.

The novelty in this case is the single-beat valve, which has so far been used only in internal combustion engine practice. All previous attempts to apply it to steam engines have miscarried. The application of this type of valve to the una-flow engine represents figuratively the keystone in the development of the latter. The fundamental conformity between the new una-flow engine and the two-stroke internal combustion engine is surprising. This refers to the uni-directional flow, the single stage expansion, the piston-controlled exhaust and the single-beat inlet valve.

Surprising also is the close agreement in the essential parts of the cylinder between the latest design shown in Fig. 3 (see Chapter VI) and the first original



sketch of a una-flow engine made in the year 1900 and reproduced in Fig. 2, which also incorporates single-beat valves.

Since, as Descartes says, doubt may be considered the origin of every philosophy, the question regarding the doubt which originated the una-flow philosophy may well be asked. This doubt arose in the year 1896 during the starting up of two pumping engines designed by myself for the Pope Mfg. Co., of Hartford, Conn. (Fig. 1). These were vertical triple expansion engines with Corliss valves and a central condensing system, in which everything then considered good practice was carried to the extreme limit. This resulted in a very complicated construction which appeared to me to be a sign of weakness. The doubts which then arose in my mind eventually led to the sketch shown in Fig. 2 during the year 1900. The construction of steam turbines of several stages, which began at that time,

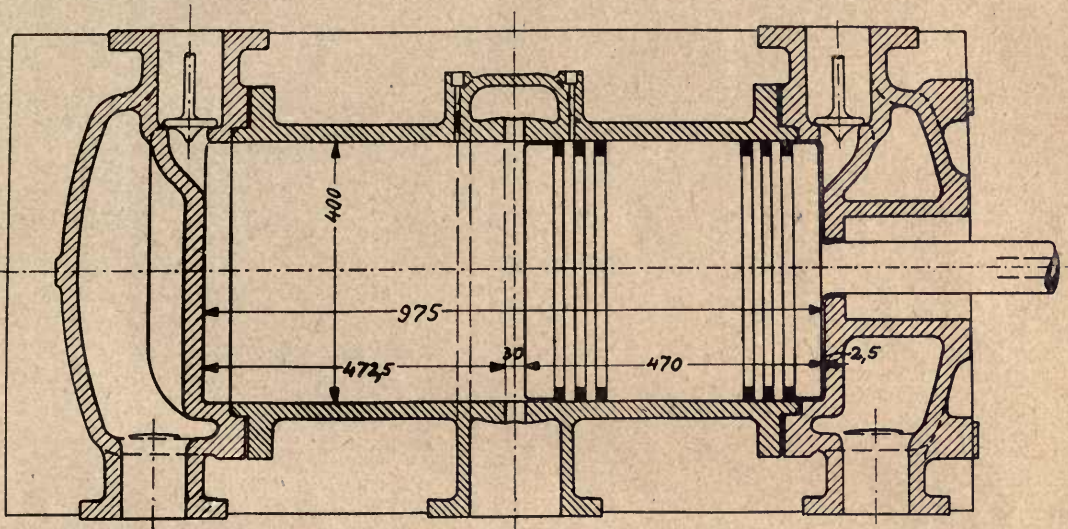


Fig. 3.

was developed along the lines of pure uni-directional flow, and this brought up the question whether it would not be possible to raise the reciprocating steam engine to the same thermal plane as the turbine by the use of the una-flow principle. The application of the una-flow action of the turbine to the steam engine, although in a somewhat imperfect manner, by properly designing the cylinder, valve gear, steam jackets and condenser connection, etc., finally led to the una-flow engine with single-beat valves as shown in Fig. 3. The object in view was the attainment of the minimum total of all the seven different losses of the steam engine, as well as the utmost simplicity and reliability of operation. This goal now seems to have been fully reached. The fact that the una-flow engine possesses the uni-directional flow in common with the steam turbine and has a constructional basis similar to that of the two-stroke internal combustion engine, may be cited in support of this.

The design and adaptation of the una-flow engine to different requirements and conditions of service represents an immense amount of work, in which I received

the full support of my assistants as well as that of Mr. Rösler of Mühlhausen, Alsace, Mr. Arendt of Saarbrücken, Prof. Bonin of Aachen, Mr. Dutta of London, and Drs. Mrongovius and Meineke of Berlin.

To the splendid support of the last four gentlemen may be attributed the positive developments of the chapters on volume loss, throttling loss, exhaust ejector action, the una-flow locomotive, and the valve gear with double speed lay shaft.

I am particularly indebted to those gentlemen who took up my proposals at a time when no one would yet believe in the una-flow engine, namely, Prof. Nolte of the Technical Hochschule at Riga, Messrs. Hnevkovsky and Smetana of Brünn, Mr. Lamey of Mühlhausen, Alsace, Mr. Müller of Berlin, and Mr. Schüler of Grevenbroich.

Berlin, January 1921.

**J. Stumpf.**

## Index.

	Page
Preface . . . . .	V
I. Steam Engine Losses . . . . .	1
1 a. Losses due to Cylinder Condensation . . . . .	1
1 b. The Una-Flow Arrangement as a Means for reducing Surface Losses. Jacketing of the Cylinder . . . . .	4
2 a. The Influence of the Clearance Volume upon the theoretical Steam Con- sumption (Volume Loss). Critical back Pressure . . . . .	13
2 b. Additional Clearance Space . . . . .	44
3 a. Losses due to Throttling. Determination of Inlet and Exhaust Port Areas	49
3 b. Relation between the Una-Flow Engine and the Condenser . . . . .	68
4. Losses due to Friction (mechanical Efficiency). Dimensioning of driving Parts	71
5. Losses due to Leakage. Valves, Pistons, Piston Rod Packings . . . . .	79
6. Losses due to Radiation and Convection . . . . .	105
7. Losses due to incomplete Expansion. The Exhaust Ejector Effect . . . . .	108
8. Prof. Nägel's Experiments . . . . .	118
II. 1. The Una-Flow Stationary Engine . . . . .	126
2. The Una-Flow Corliss Engine . . . . .	182
3. The Una-Flow Engine arranged for Bleeding . . . . .	187
4. The Una-Flow Rolling Mill Engine . . . . .	195
5. The Una-Flow Hoisting Engine . . . . .	207
6. Una-Flow Engines for driving Air Compressors, Pumps, etc. . . . .	213
III. The Una-Flow Locomotive . . . . .	225
IV. The Una-Flow Locomobile and Portable Engine . . . . .	252
V. The Una-Flow Marine Engine . . . . .	273
VI. The Una-Flow Engine with single-beat Valves and double-speed Lay Shaft	303
Summary . . . . .	316



## I. Steam Engine Losses.

The losses in a steam engine may be classified as follows:

1. Losses due to cylinder condensation (surface loss).
2. Losses due to the volume of the clearance space (clearance volume loss).
3. Loss due to throttling or wire drawing.
4. Friction loss.
5. Loss due to leakage.
6. Loss due to heat radiation and convection.
7. Loss due to incomplete expansion.

### 1a. Losses due to Cylinder Condensation (Surface Loss).

The amount of initial (or cylinder) condensation (termed surface loss in the following) is determined by the size, kind and arrangement of the harmful surfaces, by the steam jacket, by the quality of steam passing these surfaces, by the temperature gradient and the number of stages used, by the amount and period of the steam flow and the path of the steam through the cylinder (counterflow or una-flow). Initial condensation, which is usually over by the end of admission, is caused by the clearance surfaces and increased by any moisture carried over with the steam. The ability of these surfaces to receive and give off heat forms a kind of heat bypass, with a corresponding loss to the cycle. Part of the steam condenses during admission and re-evaporates during exhaust and the last part of expansion.

The harmful surfaces comprise the inner surfaces of the cylinder and the inwardly exposed surfaces of piston, piston rod and steam distributing parts. Surfaces which are continually exposed even in the dead center position of the piston may be termed harmful surfaces of the first order, and those which are progressively uncovered by the piston during its motion, harmful surfaces of the second order.

The former usually cause the essentially greater part of the surface loss. Since the amount of surface loss is determined by the extent of the harmful surfaces, the latter should be kept as small as possible and should also be machined. A good many designers pay attention only to the amount of clearance volume without considering its surface. The minimum harmful surface of the first order comprises an area equal to twice the cylinder cross-section (cylinder head and piston), and it is convenient to express the additional surface of the first order in percent of this minimum surface. In actual engines these additional surfaces, which are mostly not machined, are found to be from 150 to 200% of this minimum harmful

surface, although it is possible by careful design to reduce this figure to 3 or 5%. Piston valves with snap rings working in separate bushings, as well as slide valves with long curved ports, which latter are in most cases left rough and serve for both steam admission and exhaust, have large surfaces which are especially harmful on account of their very nature and arrangement.

Engines with separate admission and exhaust ports are far better in this respect, because the latter are usually very short and the hot admission and cold exhaust steam enter and leave the cylinder through separate passages, thereby avoiding the alternate heating and cooling of these surfaces and the corresponding surface loss which takes place in engines having common inlet and exhaust ports.

Slide and piston valve engines with their perpetual reversal of flow are subject to extensive turbulence and heat exchanges, although careful design can generally improve conditions. The Corliss engine may be considered an improvement by reason of the smallness and different arrangement of its additional surfaces; and, with the valves in the heads, the ports are straight and short with inlet and exhaust separated. Conditions can be improved still further if the exhaust valve, which forms the major part of the additional surfaces, is made to fill its bore completely and has a straight port through its center only.

Poppet valve engines in general have rather large additional surfaces, especially where valve cages are used; and notwithstanding separate inlet and exhaust ports the frequent flow reversal has a deleterious effect. Valve cages considerably increase the additional surfaces. Machining of the latter may be provided for in many cases by clever design, thereby reducing their extent and the corresponding turbulence and surface loss.

Further means of reducing the surface loss are:

1. Jacketing,
2. Compounding,
3. Superheating,
4. The una-flow system.

Jacketing of the harmful surfaces is a further step in reducing surface losses. The heating medium is usually steam, seldom flue gases. Engines with great surface losses will be largely benefited by jacketing, and single cylinder condensing engines working with saturated steam will show the greatest gain since they offer the largest scope for improvement. The effect of the jacket is diminished if the expansion takes place in two, three, or four stages, and if the steam is superheated in addition. These means improve the thermal condition to such an extent that there is little to be gained from jacketing. This applies to superheating, especially if the whole working cycle takes place in the range of superheat. Locomotives, in which the steam, when leaving the cylinder is still superheated, will derive no benefit from jacketing. Superheating is such a far reaching remedy that the number of stages in counterflow engines working with superheated steam has been generally reduced from three to two for condensing operation, and from two to one when operating non-condensing.

Increased speed, later cut-offs, and larger units tend to reduce the surface losses and hence the effects of jacketing. High speed damps the temperature fluctuations of the walls; the late cut-off raises the mean wall temperature; and

the larger size gives a more favorable ratio of volume to surface. For these reasons a large, fast running, and heavily loaded engine will show the least gain from jacketing, especially if working with superheated steam or a small temperature gradient. All this applies to superheated steam locomotives as an example.

Jacketing has the greatest effect in low pressure cylinders, since surface losses, temperature gradient, and jacket surfaces are large and the weight ratio of jacket to working steam is the most favorable. The gain from jacketing is accordingly smaller in intermediate and high pressure cylinders, and in many cases there is hardly any in the latter. Similar conditions prevail in two cylinder compound engines. Head jacketing is usually more effective than cylinder jacketing because the cylinder surfaces are temporarily covered by the piston, and the oil film acts as a heat insulator. These surfaces of the second order cause small surface losses and consequently show a smaller gain from jacketing.

Saturated steam is very bad in this respect because the water particles act as heat conductors and increase the surface losses. Dry steam is better, and best of all is superheated steam. Saturated steam is an excellent, and superheated steam a very poor heat conductor. The action of the cylinder becomes the more adiabatic the more the superheated region extends through the cycle. Superheat, furthermore, by increasing the specific volume, makes the steam lighter and reduces both the weight per cycle and the surface loss. The commonly prevailing amount of superheat allows non-condensing engines to work in the superheated region throughout the cycle; but this is not the case with condensing engines, assuming proper ratios of expansion in both cases. In condensing engines the low pressure part of the cycle always extends beyond the saturation point.

Superheating is of such far reaching effect that the reduction of harmful surfaces, their arrangement, and in many cases even jacketing, lose their importance. Generally speaking, among the different ways of reducing surface losses, one or the other may be so effective that there is nothing left for the remaining ones.

The amount, extent and kind of steam flow, especially of the exhaust, may have considerable influence in engines working with saturated steam. Wet exhaust steam flowing with high velocity through long unfinished ports having large surfaces may cause great surface losses.

Summing up, it may be stated that the application of the different means for reducing initial condensation resulted in the common use of the two-cylinder compound engine for condensing service, for the reason that the low pressure part of the cycle takes place in the saturated region. The una-flow principle, however, permits the use of the single cylinder single-stage expansion engine for this service, since the uni-directional flow of steam eliminates initial condensation despite the fact that a part of the cycle takes place in the saturated region. The una-flow principle is also of great advantage for non-condensing and multi-stage engines.

## 1b. The Una-Flow Arrangement as a Means for Reducing Surface Losses.

The una-flow engine, as its name indicates, utilizes the steam energy by a uni-directional flow, i. e. the steam passes through the cylinder always in the same direction. As shown in Fig. 1, the steam enters the cylinder head from below, heats the surface of the latter, and then enters the cylinder through the inlet valves located in the top portion of the head. Doing useful work, the steam follows the

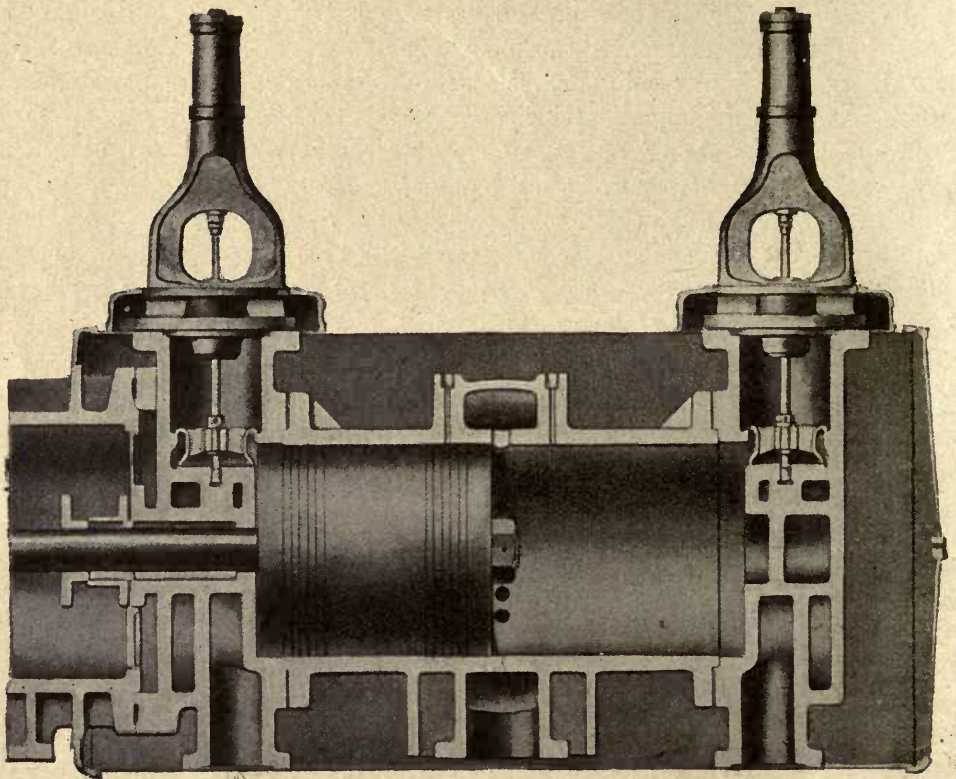


Fig. 1.

piston and after having expanded, leaves through ports at the opposite end of the stroke, i. e. in the middle of the cylinder; the opening and closing of these ports being accomplished by the piston during its motion. This is in marked contrast to the ordinary or counterflow engine, where the steam enters at the end of the cylinder, follows the piston during the working stroke, and, returning with the piston, leaves at the cylinder end. The result of this kind of flow is an intensive cooling action upon the clearance surface, the exhaust steam being



usually wet and thus an excellent heat conductor. The consequence is increased initial or cylinder condensation during the following admission. The una-flow principle avoids the cooling of the clearance surfaces, thereby eliminating initial condensation to such an extent that compounding becomes superfluous. Una-flow engines may, therefore, be built with a single cylinder and single-stage expansion, and yet show the economy of compound or triple-expansion engines.

The exhaust ports of the una-flow cylinder have an area about three times as large as can be realized with slide or poppet valves, with a consequent complete pressure equalization between cylinder and condenser if long and restricted passages between them are avoided. In other words, if the condenser is placed close to the cylinder and the connection is of ample area, then complete equalization of pressures is assured. In order to get a clear conception of the magnitude of this port area one has to consider that the engine piston acts as a piston valve and the crank as eccentric, while the cylinder constitutes the valve bushing. The exhaust lead is usually taken at 10%, which fixes the compression at 90%.

The una-flow exhaust ports do away with separate exhaust valves and their leakage loss, their additional clearance volume and surface, as well as the necessary valve gear. The elimination of exhaust valves is therefore an additional advantage of the una-flow construction.

Indicator cards of una-flow engines show adiabatic lines for expansion and compression.

Adiabatic expansion results in considerable moisture even with highly superheated steam. The entropy chart shows at a glance that with an initial pressure of 12 at. and a temperature of 300° C an expansion to 0.8 at. abs. produces 7% moisture. During the exhaust period this expansion continues until at a terminal pressure of 0.1 at. abs. the moisture amounts to 17%. On account of the unavoidable heat losses, the temperature at the end of admission will be somewhat less than the above, with a consequent increase in the final moisture.

The extension of the working cycle into the wet region rendered compound engines necessary, the high pressure cylinder working with superheated, and the low pressure cylinder with saturated steam. The una-flow system made a return to the single stage engine possible for both superheated and saturated steam.

Superheated steam is a very effective means of combating initial condensation. The combined use of superheat and the una-flow construction will still better conserve the heat during admission. Expansion will therefore start at a higher temperature and terminate with less moisture; or in other words, better economy will result.

The head jackets have the effect of a partial regeneration of the steam during expansion and exhaust. On account of the large difference of temperature, the large heating surface, and the great difference in the specific weights of the live steam and the exhaust or compression steam, an intensive heating action takes place during expansion, exhaust, and compression. This affects particularly that part of the steam located close to the cylinder head, while in consequence of the adiabatic expansion that part following the piston will sustain both a drop in temperature and an increase in moisture. The greater part of the moisture produced will accordingly be found close to the piston head with a progressive dryness and

an increase in temperature towards the cylinder head. This moist steam, being close to the exhaust ports, will escape first when they are uncovered, while that part which received heat from the head jacket is trapped by the returning piston and compressed along adiabatic lines, partly as saturated, and partly as superheated steam, but mostly the latter, because during the early part of compression heat is still being transmitted to it from the head jacket. This elimination of liquid condensate avoids its deleterious effect of heat exchange as well as damage due to water hammer.

Tests conducted on triple-expansion engines in regard to the action of steam jackets have shown that there is no gain in high pressure cylinders, very little in intermediate cylinders, but a large gain in low pressure cylinders, despite the large heat losses prevailing in cylinders of the usual type. Owing to the counterflow action, a great part of the jacket heat is necessarily carried by the exhaust steam into the condenser. One has only to consider that at the time of exhaust valve opening a considerable amount of pressure energy is available to exhaust the steam with velocities as high as 350 to 400 m. per sec., that the steam with this velocity impinges on the clearance surfaces, depositing water, and that on account of the sudden drop in pressure the heat absorbed by them during admission starts an intensive re-evaporation which extracts considerable quantities of heat from these surfaces. The fact that the latter are in many cases jacketed presents a most unfavorable picture of the very inefficient way in which admission and jacket heat are utilized. From the point of exhaust valve opening up to the beginning of compression the jacket heat is carried into the condenser in the most wasteful fashion. During the remaining part of the cycle, heat exchange occurs under more unfavorable conditions and at lower velocities, but notwithstanding the immense losses of jacket heat the low pressure cylinder derives the greatest benefit from steam jackets. This may be explained by the fact that the low pressure cylinder has the greatest temperature differences, the greatest heating surfaces, the greatest surface losses, and a very favorable density ratio of jacket to working steam. It follows that una-flow cylinders necessarily have a particularly energetic heating action, since, as in the case of low pressure counterflow cylinders, heating takes place under the influence of the full temperature difference, the large surfaces, and the great difference in density of jacket and working steam. The counterflow of steam, with its great losses, is replaced by the uni-directional flow where no jacket heat is lost to the exhaust. As shown in Fig. 2, exhaust steam in a una-flow cylinder never passes heated surfaces. The layer next to the cylinder head, at the very worst, approaches the exhaust ports without leaving the cylinder, and therefore hardly any jacket heat can be lost. The beneficial effect of steam jackets proved to exist in low pressure counterflow cylinders must therefore be in evidence in a high degree in una-flow cylinders, since a loss of jacket heat is avoided.

It is assumed, of course, that jacketing is limited to the cylinder head and that the cylinder is unjacketed (Fig. 1 and 2). The head jacket extends to the point where cut-off normally occurs so that the clearance surfaces of the first order are effectively heated from the outside, while the highly superheated compression steam prevents cooling from the inside.

A further reduction of surface losses can be accomplished by enlarging the jacket surfaces and by the utmost reduction and machining of clearance surfaces. Even though the clearance surfaces in a una-flow engine are exposed during the whole cycle, they are not subject to the rush of exhaust steam passing them, nor to re-evaporation; and they therefore suffer little cooling on account of the comparative tranquility of the steam molecules adjacent thereto, and furthermore have the benefit of both the jacket and compression heat. All these causes combined with the una-flow principle and una-flow construction produce an almost adiabatic action of the clearance surfaces.

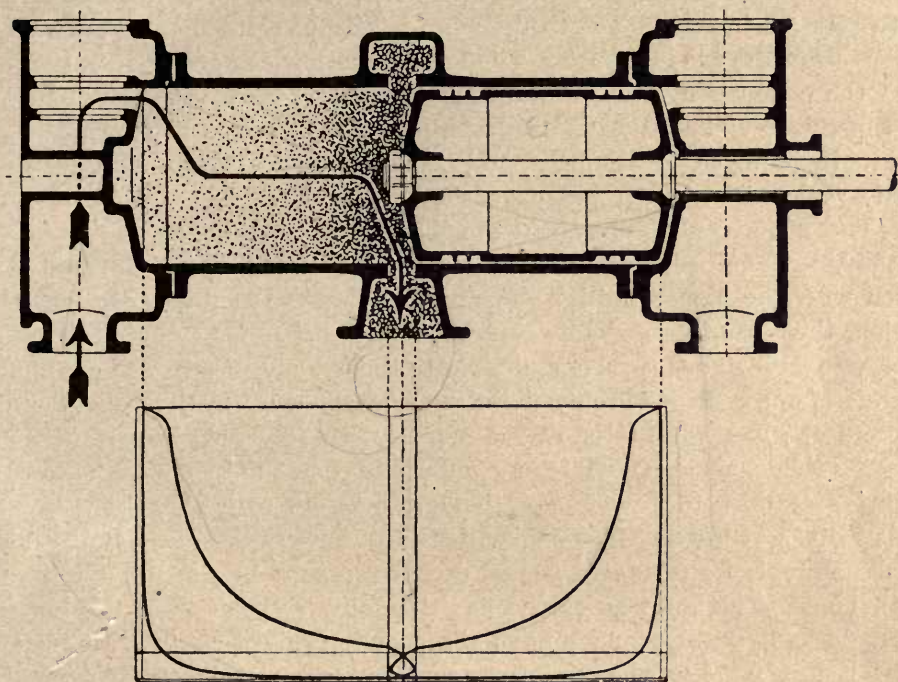


Fig. 2.

The una-flow engine fundamentally avoids the thermal mixup characterizing the counterflow engine. The cylinder is composed of two single acting cylinders with the exhaust ends in common. On account of the long piston the stroke volumes of both cylinder ends are relatively displaced for a distance equal to the length of the piston. The two inlet ends are hot and remain hot, while the common exhaust is cold and remains cold, and the temperature changes gradually from the hot inlet to the cold exhaust. The jacketing, comprising the heating chambers at the inlet ends and the cold exhaust belt around the common exhaust, is in perfect accord with this.

In a counterflow cylinder the two stroke volumes overlap. The exhaust end of one side more or less reaches to the admission end of the other, according to the length of the piston. From a thermal point of view the arrangement is obscure.

The central exhaust port and belt in the middle of the cylinder effectively cool that part of it at which the piston attains its highest velocity. This favorable

action is further augmented by the omission of jackets on the adjacent part of the cylinder. Furthermore, the piston on account of its large area exerts a very low unit pressure. The cylinder is of very simple form and can be kept free from badly distributed material, thus avoiding local heating and warping. The large bearing surface of the piston, the cooling action of the exhaust belt, as well as the simplicity of the cylinder, which precludes the possibility of warping even at the highest steam temperatures, render the use of a tail rod unnecessary, provided the material used is suitable, the design correct, and proper lubrication supplied. (See una-flow locomotives and engines built by Sulzer Bros.) The piston has two sets of rings, comprising four or six altogether. During the period of high pressures both sets are in action, and the pressure has dropped to about 3 at. when one set has overrun the exhaust ports. The many una-flow engines in operation are proof that the piston is not the cause of any difficulties even with the highest degrees of superheat, and that with good workmanship a piston can be made perfectly tight. If, however, a cylinder should become scored, its simplicity allows it to be easily replaced without great expense.

There can be no doubt about the possibility of employing, in una-flow engines of the kind described, steam temperatures far in excess of anything used at present. Even with the highest initial temperatures the cycle extends far into the moist region, thus insuring moderate working temperatures for cylinder and piston, the highly superheated steam being limited to the cylinder head. The una-flow engine, therefore, opens up further possibilities of development in the utilization of higher degrees of superheat. It is all the more suitable for this because the superheat benefits the whole cycle, while in counterflow compound engines the high pressure cylinder receives too much and the low pressure cylinder too little superheat. This feature of the una-flow engine does not, however, contradict the fact that it is also suitable for saturated steam, excellent results being actually obtained with both kinds. The una-flow engine has the uni-directional flow, the hot inlet and the cold exhaust in common with the steam turbine. From a thermal point of view it forms the missing link between the reciprocating steam engine and the steam turbine.

The opinion is frequently advanced that, in regard to their thermal action, the cylinder head and piston surfaces of a una-flow engine are merely interchanged. This leaves out of consideration the fact that the piston surface is protected against the action of the exhaust by a cone of stagnating steam. The existence of this phenomenon has been frequently proved beyond dispute in the case of air and water. The surface corresponding to the face of the slide valve of a counterflow engine is located in the una-flow engine at the circumference of the cylinder. The port necessary with a slide valve, together with the clearance and clearance surfaces involved, are completely avoided in the una-flow engine. The surfaces of the una-flow exhaust ports are outside of the cylinder and therefore have no bearing upon the thermal conditions. Piston and steam have a different velocity only after the former has opened the exhaust ports, when the available pressure energy is transformed into kinetic energy. The steam, however, attains its full velocity only after it has passed the edge of the piston and therefore the cooling action of this steam upon the piston can only be small. The cooling action caused

by the low velocity of approach in the cylinder now remains to be examined. Considering the exhaust ports as nozzles bounded on one side by the piston edge, the steam at this narrowest point attains a mean critical velocity of about 440 m/sec. On examining cross-sections ahead of this smallest section or throat, very moderate velocities are found. Fig. 3 makes these conditions clear for a cylinder of 600 mm bore and 800 mm stroke, the piston being assumed to have overrun the ports for a distance of 20 mm. Calculation of the velocity at this narrowest point shows it to be 440 m/sec., while at a distance of 15 mm ahead of this point it is only 71 m/sec.; at 40 m it is 36 m/sec.; at 85 m it is 20 m/sec., and at 130 m it is 15 m/sec. It should be noted that in considering the various cross-sections

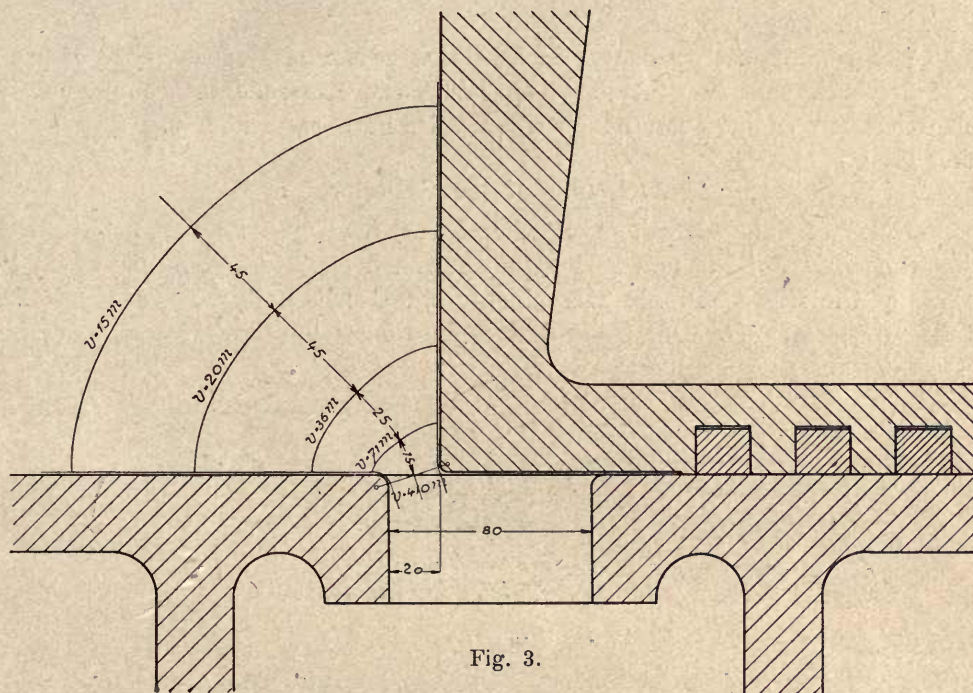


Fig. 3.

a reduction of area due to the bridges has been assumed at the narrowest section (throat), and this does not apply to the cross-sections of approach. As the piston progressively uncovers the exhaust ports the proportions of the cross-sections are changed in such a way that the velocity of approach is increased. At the same time a reduction of pressure occurs, the effect of which is to reduce the velocity of approach, beginning at the point at which the critical pressure is reached. Most indicator cards of una-flow engines show clearly that when the piston reaches the dead center the pressure inside the cylinder has dropped to the back pressure; or in other words, the greater part of the steam has in this position been exhausted. Therefore, owing to the short duration and low intensity of the flow of exhaust steam along the piston surface and the small harmful exhaust surfaces, the resulting cooling action is small. The whole cylinder section acts as an approach to the exhaust nozzles. A further protection is given by the layer of stagnating steam, and there is finally a very intense heating action during compression and admission. The

heating of the piston surface by the hot live steam is so effective that this surface acts almost adiabatically during the following exhaust period. The very favorable steam consumption figures obtained with this type of engine are further proof that a simple interchange of the cylinder head and piston surfaces, in regard to their thermal behaviour, is out of the question. Such favorable economy can only result if the piston and its cooling action is negligible. This is further confirmed by tests of Prof. Nägel. A test with saturated steam of  $184^{\circ}\text{C}$ , and a cut-off at 12%, showed that the temperature of the piston surface at a point near its circumference was about  $164.5^{\circ}\text{C}$ . The total fluctuation at this point was only  $1.3^{\circ}\text{C}$ . This surprisingly high temperature, and moreover the small fluctuation, justifies a very favorable conclusion. These figures should be still better towards the center of the piston surface.

The thermal, constructional, and operative advantages of this type of prime mover are such that in continuous operation the economies of compound and triple-expansion engines can be obtained with both saturated and superheated steam.

### Jacketing of the Cylinder.

The firm of Sulzer Brothers, of Winterthur, Switzerland, constructed an experimental engine of the una-flow type after such engines had been put on the market by the Erste Brünner Maschinenfabrik Gesellschaft, who were the first to take up the manufacture of una-flow engines on the author's recommendation.

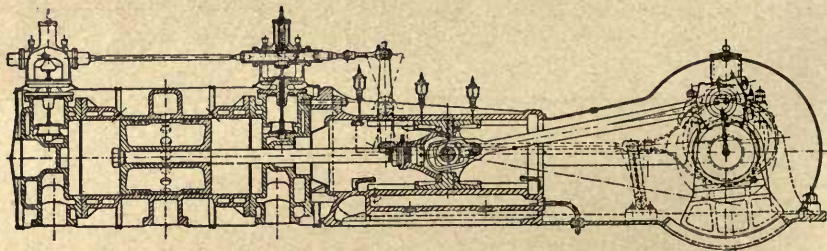


Fig. 4.

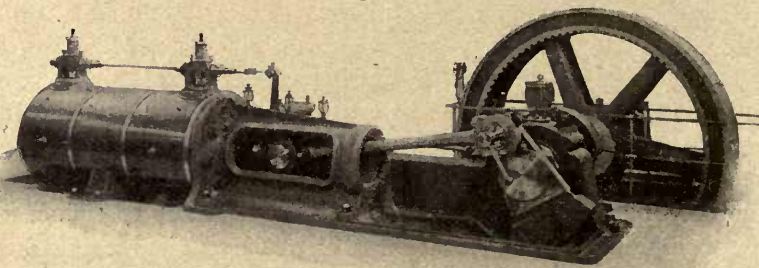


Fig. 5.

Sulzer Bros. entrusted the author with the design of the first una-flow cylinder of 600 mm bore, 800 mm stroke, and 155 r. p. m. All later Sulzer engines are built with only slight changes from this design, which is shown in Figs. 4 and 5. According to Sulzer Brothers' usual practice the engine was put on the testing floor and a great number of tests were carried out with the object of observing

its performance and determining its economy under the most varying conditions. An important part in the program was the study of the effect of the jackets. For this reason the author incorporated in this design not only head jackets, through which the live steam had to pass before entering the cylinder, but also jackets at the ends of the cylinder barrel, which were separated by a neutral zone from the exhaust belt. These cylinder jackets could be shut off separately. During the tests the head jackets were necessarily always in operation, but the cylinder jackets were either in service or shut off, as indicated in Fig. 6 by the words „with jacket“ and „without jacket“. The tests proved that the effect of the cylinder jacket decreases with increasing steam temperature. With saturated steam the difference was almost 1 kg/IHP-hour in favor of cylinder jackets, while it was barely 0.5 with steam of 265° C and only 0.2 kg with steam of 325° C. All figures referred to the most economical M. E. P. The steam pressure was 9.2 at. gage and the vacuum 66 cm.

For the point of best operating economy, i. e., an M. E. P. of about 3 kg/sqcm, these differences change in such a way that a small increase results when running with cylinder jackets and with a steam temperature of 325° C, while steam of 265° C shows a small decrease in steam consumption.

For a steam temperature of 325° C the point of equality of steam consumption, when operating both with and without cylinder jackets, is found to correspond to an M. E. P. of 2.5 kg/sqcm. The corresponding point for steam of 265° C occurs at an M. E. P. of 3.4 kg/sqcm. For saturated steam this point moves towards a still higher M. E. P.

This explains the customary omission of cylinder jackets for superheated steam.

It is also noteworthy that the best economy with steam of 325° C very closely approaches the value of 4 kg/IHP-hour. The results for saturated steam, especially with cylinder jackets, are extremely favorable. It must be considered, however, that the saturated steam had a very slight degree of superheat in order to make sure that it was actually dry. It should further be noted that this engine was well designed and well built. The clearance volume and clearance surface (the latter being machined) were moderate, and the whole engine was built with the high precision usual to Sulzer Brothers' shop practice. The measurements were made by means of a surface condenser, which, as is well known, gives slightly lower but more accurate results than boiler feed water measurements.

Comparing these curves with those of compound or triple-expansion engines, it will be found that the steam consumption of the una-flow engine is influenced

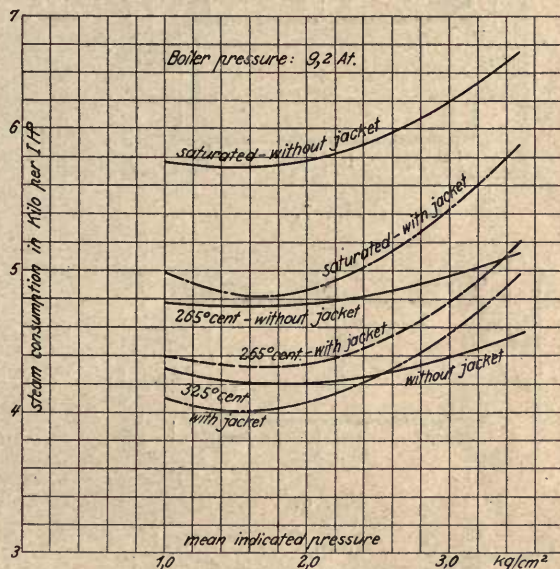


Fig. 6.

by the load to a much smaller degree. This is shown particularly by the curves marked „without jackets“, where there is hardly any change in the steam consumption between mean effective pressures of 1 and 3 kg/sqcm, especially with high superheat. Even with saturated steam little change is noticeable between mean effective pressures of 1 and 2,4 kg/sqcm.

The curves of Fig. 6 justify the following conclusions in regard to cylinder jacketing:

For highly superheated steam (300° C and more) and high mean effective pressures cylinder jacketing is useless (Fig. 7), and has a deleterious effect even at as low an M.E.P. as 3 kg/sqcm. For low mean effective pressures cylinder jackets may yet be expected to yield a small gain. For moderate steam temperatures of about 250° C a short cylinder jacket as shown in Fig. 8 is advisable. It will slightly improve the economy even for a high M.E.P. and produce considerable gain for a low M.E.P. With saturated steam or low degrees of superheat a cylinder jacket separated only by a narrow zone from the exhaust belt (Fig. 9) should be used under all circumstances. *Head jackets are essential in all cases.*

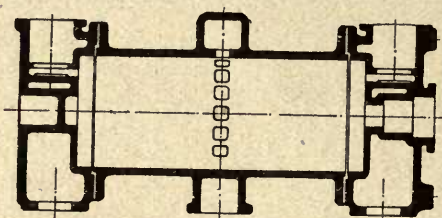


Fig. 7.

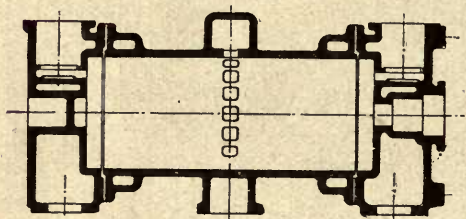


Fig. 8.

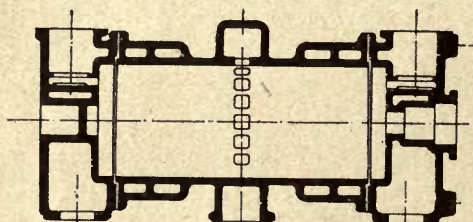


Fig. 9.

For low mean effective pressures cylinder jackets may yet be expected to yield a small gain. For moderate steam temperatures of about 250° C a short cylinder jacket as shown in Fig. 8 is advisable. It will slightly improve the economy even for a high M.E.P. and produce considerable gain for a low M.E.P. With saturated steam or low degrees of superheat a cylinder jacket separated only by a narrow zone from the exhaust belt (Fig. 9) should be used under all circumstances. *Head jackets are essential in all cases.*

The separation of cylinder jacket and exhaust belt is advisable in order to avoid unnecessary loss of jacket heat and to provide more favorable operating conditions for the piston, especially when using superheated steam. The center part of the cylinder, where the piston attains its highest speed, has the lowest temperature. Excellent results can be secured with self-supporting pistons, even with very high temperatures of superheat, if the designer pays attention to these thermal conditions by providing the piston with bearing surfaces at its center only, leaving its extremities to project in the manner of a plunger towards both ends of the cylinder without actually touching the walls.

The head jackets do not impair the operation of the piston, since no rubbing surfaces are in contact with the former. Their heating action is very effective because they are continuously in contact with the working steam; they heat harmful surfaces of the first order, and with proper lubrication the transmission of heat from them is not impeded by an oil film (Fig. 7). There is practically no loss of jacket heat to the exhaust. Conditions are not so good in Fig. 8 and still worse in Fig. 9. In these constructions the amount of jacket heat lost to the exhaust increases more and more because the exhaust steam to a certain extent flows past heated surfaces, although these may be partly protected by an oil film.

The head jackets do not impair the operation of the piston, since no rubbing surfaces are in contact with the former. Their heating action is very effective because they are continuously in contact with the working steam; they heat harmful surfaces of the first order, and with proper lubrication the transmission of heat from them is not impeded by an oil film (Fig. 7). There is practically no loss of jacket heat to the exhaust. Conditions are not so good in Fig. 8 and still worse in Fig. 9. In these constructions the amount of jacket heat lost to the exhaust increases more and more because the exhaust steam to a certain extent flows past heated surfaces, although these may be partly protected by an oil film.



## 2a. Influence of the Clearance Volume upon the theoretical Steam Consumption (Volume Loss).

(The Una-Flow System as a Means for Reducing the Volume Loss).

A certain amount of steam admitted per stroke into a cylinder with clearance will produce an indicator card of less area than in an ideal cylinder without clearance. The difference in area may be termed volume loss. This volume loss is represented in Figs. 1 to 4 for different conditions. The diagrams corresponding to the cylinder with clearance are drawn in heavy lines, while those for the ideal cylinder are shown dashed.

Volume losses can be expressed absolutely or relatively. In most cases it is convenient to figure the volume loss in per cent of the engine output.

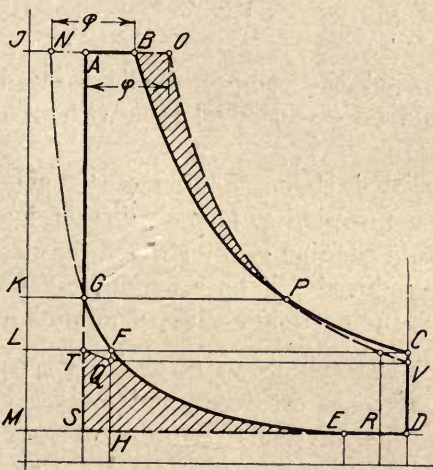


Fig. 1.

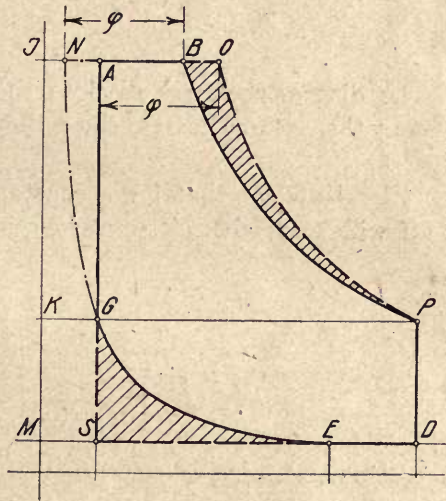


Fig. 2.

A comparison of the two areas  $AOPG$  and  $ABPG$  in Fig. 1 shows area  $BOP$  to be a loss. The parts of the diagrams lying below the line  $GP$  show a loss of the area  $GES$  and a gain of area  $PCV = GFQT$ . By subtracting the latter, the resultant loss is represented by the area  $TQFES$ .

In Fig. 2 the admission has been lengthened until the points  $F$  and  $P$  of Fig. 1 coincide with the beginning and ending of the diagram. Consequently the shaded areas  $BOP$  and  $GES$  represent the loss for the diagram with clearance.

In Fig. 3, with still longer admission, a comparison of the diagrams shows the loss to be equal to the shaded areas  $BOVC$  and  $GHS$ .

The reduction in diagram area produces a corresponding increase of the loss due to incomplete expansion. A special case is shown in Fig. 4, which represents a diagram without volume loss. This may occur for instance in high pressure cylinders of compound engines when expansion is carried to the back pressure and compression to the initial pressure. Although the diagram has no direct

volume loss, the stroke volume of the cylinder with clearance must be increased from  $V_1$  to  $V_2$ , with a consequent increase in the surface loss.

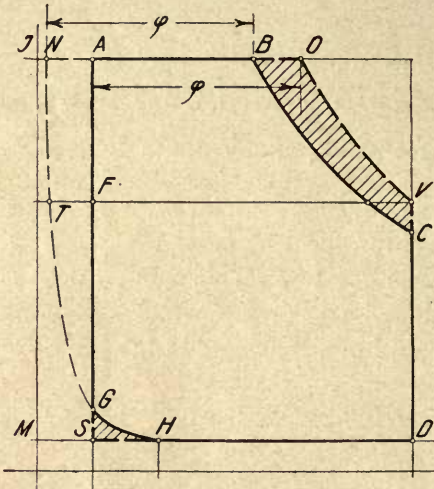


Fig. 3.

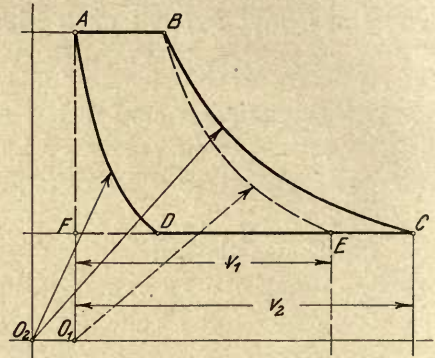


Fig. 4.

The diagrams clearly disclose the fact that the compression is a means of reducing the volume losses, since they would be essentially larger without compression.

It is also clear that for a constant admitted steam volume  $\phi$  the point of cut-off will vary with different lengths of compressions. There will therefore be a certain position of  $\phi$  for which the diagram area produced will be a maximum and the corresponding volume loss a minimum.

a) Determination of the best position of  $\phi$ , if  $pv = \text{constant}$ , and  $p_1, p_2, \phi$  and  $S_0$  are known (see Fig. 5).

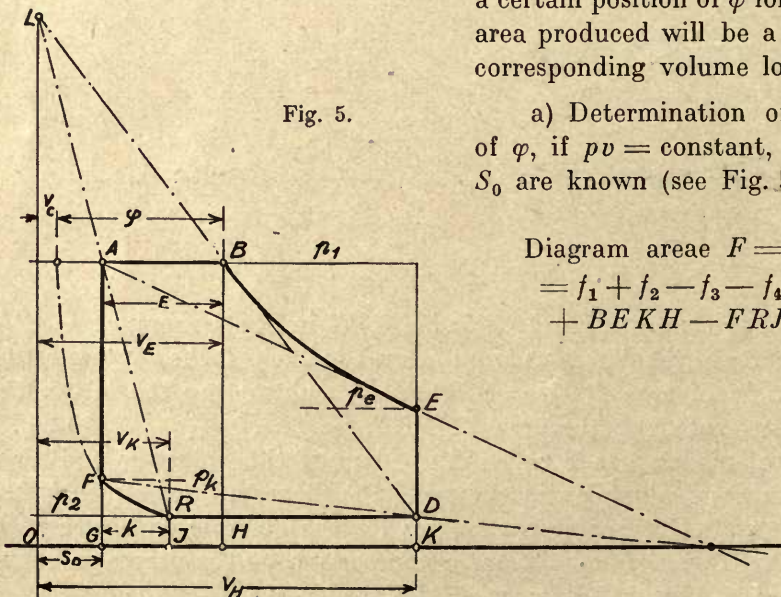


Fig. 5.

$$\begin{aligned} \text{Diagram area } F &= ABEDRF = \\ &= f_1 + f_2 - f_3 - f_4 = ABHG + \\ &+ BEKH - FRJG - RDKJ. \end{aligned}$$

The admitted steam volume  $\varphi = V_E - V_C$  and  $V_C = \frac{p_2}{p_1} \cdot V_K$  and  $V_K = (V_E - \varphi) \cdot \frac{p_1}{p_2}$ .

Therefore:  $f_1 = p_1 (V_E - S_0)$ ;  $f_2 = \int_{V_E}^{V_H} p dv = V_E p_1 \log_e \frac{V_H}{V_E}$ ;

$$f_3 = \int_{S_0}^{V_K} p dv = V_K p_2 \log_e \frac{V_K}{S_0} = (V_E - \varphi) p_1 \log_e \frac{(V_E - \varphi) \frac{p_1}{p_2}}{S_0};$$

$$f_4 = (V_H - V_K) p_2 = V_H \cdot p_2 - (V_E - \varphi) p_1;$$

$$F = p_1 (V_E - S_0) + V_E p_1 \log_e \frac{V_H}{V_E} - (V_E - \varphi) p_1 \log_e \frac{(V_E - \varphi) \frac{p_1}{p_2}}{S_0} - V_H \cdot p_2 + (V_E - \varphi) \cdot p_1.$$

Required is the maximum diagram area for  $\varphi = \text{constant}$ . The independent variable is  $V_E$ . Therefore:

$$\frac{dF}{dV_E} = p_1 + p_1 \log_e \frac{V_H}{V_E} - V_E \cdot p_1 \frac{\frac{V_H}{V_E^2}}{\frac{V_H}{V_E}} - p_1 \log_e \frac{V_E - \varphi}{S_0} \cdot \frac{p_1}{p_2} - (V_E - \varphi) p_1 \frac{\frac{1}{S_0} \cdot \frac{p_1}{p_2}}{\frac{V_E - \varphi}{S_0} \cdot \frac{p_1}{p_2}} + p_1 = 0$$

$$\frac{dF}{dV_E} = p_1 \log_e \frac{V_H}{V_E} - p_1 \log_e \frac{V_E - \varphi}{S_0} \cdot \frac{p_1}{p_2} = 0, \text{ or } \frac{V_H}{V_E} = \frac{V_E - \varphi}{S_0} \cdot \frac{p_1}{p_2};$$

$$\text{or } V_E = \frac{\varphi}{2} \pm \sqrt{\frac{\varphi^2}{4} + V_H \cdot S_0 \frac{p_2}{p_1}} \quad \dots \quad \text{(I)}$$

$$\text{Since } (V_E - \varphi) \frac{p_1}{p_2} = V_K, \text{ therefore } \frac{V_H}{V_E} = \frac{V_K}{S_0} \text{ or } \frac{p_1}{p_e} = \frac{p_k}{p_2} \quad \dots \quad \text{(II)}$$

This result is graphically represented in Fig. 5. A straight line is drawn through  $D$  and  $B$ , and intersects the vertical axis at  $L$ . Another line is drawn through  $L$  and  $A$ , intersecting the back pressure line at  $R$ , and this point determines the best compression for the assumed values of  $V_E$  and  $S_0$ . Another method consists in finding the intersection with the horizontal axis of a line through  $A$  and  $E$ , and drawing a line from this intersection through the point  $D$  to cut the vertical line through  $A$  at the point  $F$ , which latter thus determines the best terminal compression pressure.

The method of Fig. 5 cannot, however, be used to find  $V_k$  if  $\varphi$  is given. In this case equation I may be used to find  $V_E$ , and when this quantity is known  $V_k$  can be found either by equation II or the graphic method shown in Fig. 5.

From Fig. 5 it will be seen that early cut-offs are associated with long compressions and vice versa. In case of a cut-off at 100% the intersection of the line

$DB$  with the vertical axis moves to infinity. Consequently the intersection of the line  $AR$  with this axis must be at infinity; in other words the line is parallel to the axis and thus gives a length of compression equal to zero. For a cut-off equal to 0%, the two lines  $AR$  and  $BD$  coincide and the compression therefore is 100%.

Fig. 6 represents the case in which the terminal expansion pressure equals the back pressure. The corresponding compression reaches the initial pressure, this being a condition which remains true also for polytropic lines.

At a smaller cut-off than  $a$  in Fig. 6 the expansion and compression lines both form loops, since the terminal expansion pressure falls below the back pressure and the compression exceeds the initial pressure. A loop in the expansion line, therefore, corresponds to a loop in the compression line. Such a diagram laid out according to Fig. 5 would be correct from the point of view of volume loss.

Large clearance volumes are accompanied by large volume losses, and on the basis of these great losses a change in the length of compression may produce

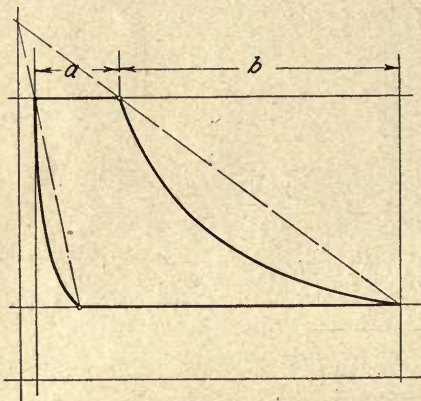


Fig. 6.

a considerable gain. Small clearance volumes permit the use of constant compression, since a change in the length of compression could result only in a small gain in view of the slight volume loss, and with many types of valve gear such a change would give inadmissibly high compression pressures. Non-condensing engines, such as locomotives for instance, which have about 12% clearance, are usually fitted with gears which vary the length of compression inversely with the cut-off. A link valve gear, aside from the large clearance volume caused by its use, gives a qualitatively correct change in the

length of compression and also, as will be proved later, a change which is also quantitatively correct. Similar conditions prevail in a single valve non-condensing engine having about 12% clearance in which the shaft governor alters the throw and angle of advance of the driving eccentric.

*The large clearance necessitated by both these types of valve gear is a great disadvantage, which is only partly remedied by a correct variation in the length of compression.*

In the case of condensing engines a variation of the length of compression gives very little improvement, as will be shown later. Constant compression is allowable and long compression desirable.

The use of constant compression for small clearances is in accord with the case of zero clearance volume, since, in accordance with Fig. 6, it requires a constant length of compression equal to zero for a cut-off at any point of the stroke.

b) Determination of the best position of  $\varphi$  when  $p v^n = \text{constant}$  and  $p_1, p_2, \varphi$  and  $S_0$  are known (see Fig. 5).

$$f_1 = p_1 (V_E - S_0)$$

$$f_2 = \frac{p_1 V_E^n}{1-n} (V_H^{1-n} - V_E^{1-n}) = \frac{1}{1-n} p_1 V_H^{1-n} V_E^n - \frac{p_1}{1-n} V_E$$

$$f_3 = \frac{p_2 V_K^n}{1-n} (V_K^{1-n} - S_0^{1-n}) \text{ or with } V_K = V_C \left(\frac{p_1}{p_2}\right)^{\frac{1}{n}} = (V_E - \varphi) \left(\frac{p_1}{p_2}\right)^{\frac{1}{n}}$$

$$= \frac{p_2}{1-n} \left(\frac{p_1}{p_2}\right)^{\frac{1}{n}} (V_E - \varphi) - \frac{p_1}{1-n} S_0^{1-n} (V_E - \varphi)^n$$

$$f_4 = p_2 (V_H - V_K) = p_2 V_H - p_2 \left(\frac{p_1}{p_2}\right)^{\frac{1}{n}} (V_E - \varphi).$$

These areas as previously combined give:

$$F = p_1 (V_E - S_0) + \frac{1}{1-n} p_1 V_H^{1-n} V_E^n - \frac{p_1}{1-n} V_E - \frac{p_2}{1-n} \left(\frac{p_1}{p_2}\right)^{\frac{1}{n}} (V_E - \varphi) +$$

$$+ \frac{p_1}{1-n} S_0^{1-n} (V_E - \varphi)^n - p_2 \cdot V_H + p_2 \left(\frac{p_1}{p_2}\right)^{\frac{1}{n}} (V_E - \varphi).$$

For a minimum value of  $F$ ,  $\frac{dF}{dV_E} = 0$ .

$$\frac{dF}{dV_E} = p_1 + \frac{n}{1-n} \cdot p_1 V_H^{1-n} V_E^{n-1} - \frac{p_1}{1-n} - \frac{p_2}{1-n} \left(\frac{p_1}{p_2}\right)^{\frac{1}{n}} +$$

$$+ \frac{n}{1-n} \cdot p_1 S_0^{1-n} (V_E - \varphi)^{n-1} + p_2 \left(\frac{p_1}{p_2}\right)^{\frac{1}{n}} = 0$$

or:

$$\frac{n}{1-n} \cdot p_1 \left(\frac{V_E}{V_H}\right)^{n-1} + \frac{n}{1-n} \cdot p_1 \left(\frac{V_E - \varphi}{S_0}\right)^{n-1} = \frac{n}{1-n} p_1 + \frac{n}{1-n} \cdot p_2 \left(\frac{p_1}{p_2}\right)^{\frac{1}{n}}$$

or:

$$\underline{\left(\frac{V_E}{V_H}\right)^{n-1} + \left(\frac{V_E - \varphi}{S_0}\right)^{n-1} = 1 + \left(\frac{p_2}{p_1}\right)^{\frac{n-1}{n}} \dots \dots \dots \text{ (III).}}$$

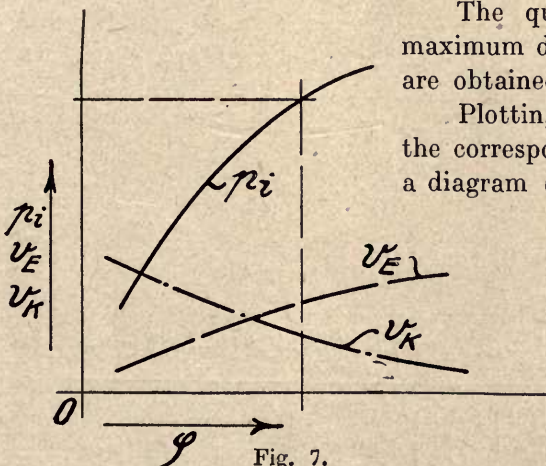


Fig. 7.

Stumpf, The una-flow steam engine.

The quantities  $V_E$ ,  $V_K$  and  $\varepsilon$  giving the maximum diagram area for constant value of  $\varphi$  are obtained from equations I, II and III.

Plotting the calculated values of  $\varepsilon$ ,  $V_K$  and the corresponding mean effective pressures  $p_i$  in a diagram (Fig. 7) with  $\varphi$  as abscissae and  $V_E$ ,  $V_K$  and  $p_i$  as ordinates, the best combination of  $\varphi$ ,  $V_E$  and  $V_K$  may be read off for a given value of  $p_i$ .

A different problem is presented by the determination of that length of compression  $K$  which results in the lowest steam consumption for a given constant quantity  $\varepsilon$  (Fig. 8).

a) Assuming  $pv = \text{constant}$ .

Equations for  $f_1, f_2, f_3, f_4$  are as before. The smallest steam consumption  $C = \frac{\varphi}{F}$  is to be found; or for simplicity, the maximum value of the fraction

$$\Theta = \frac{1}{C} = \frac{F}{\varphi}$$

$$\text{Hence } \Theta = \frac{p_1(V_E - S_0) + p_1 V_E \log_e \frac{V_H}{V_E} - p_2 V_K \log_e \frac{V_K}{S_0} - p_2(V_H - V_K)}{V_E - V_K \cdot \frac{p_2}{p_1}}$$

The independent variable is  $V_K$ , therefore  $\frac{d\Theta}{dV_K} = 0$

$$\frac{d\Theta}{dV_K} = \frac{\left\{ V_E - V_K \frac{p_2}{p_1} \right\} \left\{ -p_2 - p_2 \log_e V_K + p_2 \log_e S_0 + p_2 \right\}}{\left( V_E - V_K \frac{p_2}{p_1} \right)^2} - \frac{\left\{ p_1(V_E - S_0) + p_1 V_E \log_e \frac{V_H}{V_E} - p_2 V_K \log_e V_K + p_2 V_K \log_e S_0 - p_2(V_H - V_K) \right\} \left\{ -\frac{p_2}{p_1} \right\}}{\left( V_E - V_K \frac{p_2}{p_1} \right)^2} = 0$$

$$-p_2 V_E \log_e V_K + p_2 V_E \log_e S_0 + \frac{p_2^2}{p_1} V_K \log_e V_K + \frac{p_2^2}{p_1} V_K \log_e S_0 + p_2(V_E - S_0) +$$

$$+ p_2 V_E \log_e \frac{V_H}{V_E} - \frac{p_2^2}{p_1} V_K \log_e V_K + \frac{p_2^2}{p_1} V_K \log_e S_0 - \frac{p_2^2}{p_1} (V_H - V_K) = 0$$

or: 
$$\underline{V_K - \frac{p_1}{p_2} V_E \log_e V_K = V_H - \frac{p_1}{p_2} (V_E - S_0) - \frac{p_1}{p_2} V_E \left( \log_e \frac{V_H}{V_E} S_0 \right)} \quad \text{(IV).}$$

b)  $pv^n = \text{constant}$ .

As previously,

$$\Theta = \frac{p_1(V_E - S_0) + \frac{p_1 V_E^n}{1-n} (V_H^{1-n} - V_E^{1-n}) - \frac{p_2 V_K^n}{1-n} (V_K^{1-n} - S_0^{1-n}) - p_2(V_H - V_K)}{V_E - V_K \left( \frac{p_2}{p_1} \right)^{\frac{1}{n}}},$$

for smallest steam consumption

$$\frac{d\Theta}{dV_K} = 0, \text{ therefore}$$

$$\frac{\left\{ V_E - V_K \left( \frac{p_2}{p_1} \right)^{\frac{1}{n}} \right\} \left\{ (V_K^{1-n} - S_0^{1-n}) \left( \frac{p_2}{1-n} \cdot n \cdot V_K^{n-1} \right) + \frac{p_2}{1-n} V_K^n (1-n) V_K^{-n} - p_2 \right\}}{\left\{ V_E - V_K \left( \frac{p_2}{p_1} \right)^{\frac{1}{n}} \right\}^2} = 0;$$

Again,

$$\left\{ -p_1(V_E - S_0) - \frac{p_1 V_E^n}{1-n} (V_H^{1-n} - V_E^{1-n}) + \frac{p_2 V_K^n}{1-n} (V_K^{1-n} - S_0^{1-n}) + p_2(V_H - V_K) \right\} - \left( \frac{p_2}{p_1} \right)^{\frac{1}{n}} = 0$$

$$\left\{ V_E - V_K \left( \frac{p_2}{p_1} \right)^{\frac{1}{n}} \right\}^2$$

$$S_0 \left( \frac{V_K}{S_0} \right)^n - \frac{n}{n-1} \left( \frac{p_1}{p_2} \right)^{\frac{1}{n}} V_E \left( \frac{V_K}{S_0} \right)^{n-1} = V_H - \frac{n}{n-1} \left( \frac{p_1}{p_2} \right)^{\frac{1}{n}} V_E - \frac{p_1}{p_2} \left[ (V_E - S_0) + \frac{V_E}{n-1} \left\{ 1 - \left( \frac{V_E}{V_H} \right)^{n-1} \right\} \right] \quad (V).$$

Equations III, IV and V can be solved only by trial and error. Furthermore, the expansion and compression lines especially of superheated steam, do not closely follow the law  $p v^n = \text{constant}$ ; the following method based on adiabatic expansion and compression, and on the use of the Mollier chart is therefore preferable because it permits of the exact determination of the steam consumption for given values of the quantities  $p_1, p_2, S_0, V_E$  and  $V_K$ .

It is assumed that the following conditions hold true: Adiabatic expansion and compression, quality of steam at beginning of compression equal to quality obtained by expanding adiabatically to the back pressure, cylinder stroke volume = 1 sqm  $\times$  1 m = 1 cbm; gain of heat due to bringing compression steam up to initial pressure neglected.

The following symbols are used:

- $\Delta i_e$  Change of total heat during expansion in cal/kg.
- $\Delta i_c$  " " " " " " " " compression in cal/kg.
- $S_0$  Clearance volume in %.
- $p_1, V_1$  Initial pressure kg/sqcm and specific volume cbm/kg.
- $p_e, V_e$  Terminal expansion pressure kg/sqcm and specific volume cbm/kg.
- $p_2, V_2$  Back pressure kg/sqcm and specific volume cbm/kg.
- $p_k, v_k$  Terminal compression pressure kg/sqcm and specific volume cbm/kg.
- $\epsilon$  Length of admission in %.
- $k$  Length of compression in %.
- $v_c$  Volume of compression steam reduced to initial pressure in percent of stroke.

The area of the indicator card is subdivided into the following four parts (Fig. 8):

$$f_1 = A'BCC'; \quad f_2 = C'CDD';$$

$$f_3 = F'FED'; \quad f_4 = A'AFF'.$$

Determination of these separate areas:

a) Area  $f_1$ : The work for 1 kg of steam expanding adiabatically from  $p_1$  to  $p_e$  is  $427 \cdot \Delta i_e$  mkg. In a cylinder of 1 cbm stroke volume the weight of the working steam is

$$\frac{S_0 + \epsilon}{100} \cdot \frac{1}{v_1} \text{ kg,}$$

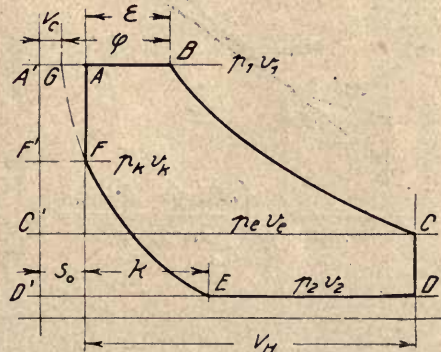


Fig. 8.

therefore the work represented by the area  $f_1$  is equal to

$$L_1 = 427 \cdot \Delta i_e \cdot \frac{S_0 + \varepsilon}{100} \cdot \frac{1}{v_1} \text{ mkg}$$

b) Area  $f_2$ : For a cylinder having 1 cbm stroke volume the work is equal to

$$L_2 = 10000 (p_e - p_2) \frac{100 + S_0}{100} \text{ mkg.}$$

c) Area  $f_3$ : Again, the work for 1 kg steam =  $427 \cdot \Delta i_c$  mkg. In a cylinder of the assumed stroke volume the weight of compression steam is

$$\frac{S_0 + k}{100} \cdot \frac{1}{v_2} \text{ kg,}$$

Therefore, the work corresponding to area  $f_3$  is

$$L_3 = 427 \Delta i_c \frac{S_0 + k}{100} \cdot \frac{1}{v_2} \text{ mkg.}$$

d) Area  $f_4$ : For the same stroke volume,

$$L_4 = 10000 (p_1 - p_k) \frac{S_0}{100} \text{ mkg.}$$

e) The area of the indicator card is:  $F = f_1 + f_2 - f_3 - f_4$ , and the indicated work is:  $L_i = L_1 + L_2 - L_3 - L_4$  mkg.

f) The mean effective pressure:  $p_i = \frac{L_i}{10000}$  kg/sqcm.

g) Steam consumption: The admitted weight of live steam

$$\frac{\varepsilon + S_0 - V_c}{100} \cdot \frac{1}{v_1} \text{ kg}$$

The corresponding work is  $L_i$  mkg. The work for one H. P. hour being =  $75 \cdot 60 \cdot 60 = 270000$  mkg, the steam consumption is

$$C = \frac{270000}{L_i} \cdot \frac{\varepsilon + S_0 - V_c}{100} \cdot \frac{1}{v_1} \text{ kg/1 HP-hour} \dots \dots \dots \text{(VI)}$$

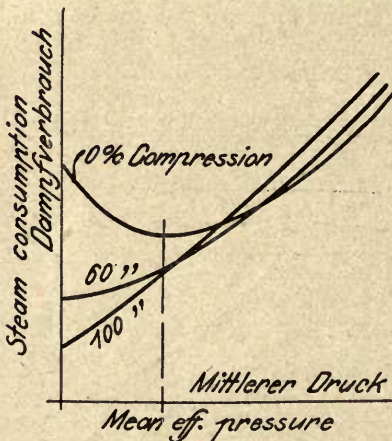


Fig. 9.

The quantities  $V_c$ ,  $p_e$ ,  $\Delta i_e$ ,  $\Delta i_c$  and  $p_k$  can be obtained directly from the Mollier chart.

The values plotted in the following diagrams were obtained by this method.

In Figs. 10, 11, 12, 13, 14 and 15 the steam consumption for an initial pressure of 14 at. abs., 1 at. abs. back pressure, superheated steam of 300° C and clearance volumes of 5, 8 and 11%, has been plotted against the length of compression  $k$ , for various values of constant values  $\varepsilon$  and constant M.E.P. The construction of auxiliary diagrams (Fig. 9) is recommended for determining the curves of M.E.P., the abscissae representing M.E.P., and the ordinates the steam consumption. These curves are plotted for constant compression, and a vertical line intersecting them determines the values of the steam consumption for a given constant mean effective pressure.



The great influence exerted by the compression upon the steam consumption is shown in Figs. 10, 11, 12, 13, 14 and 15. As indicated by previous results, the

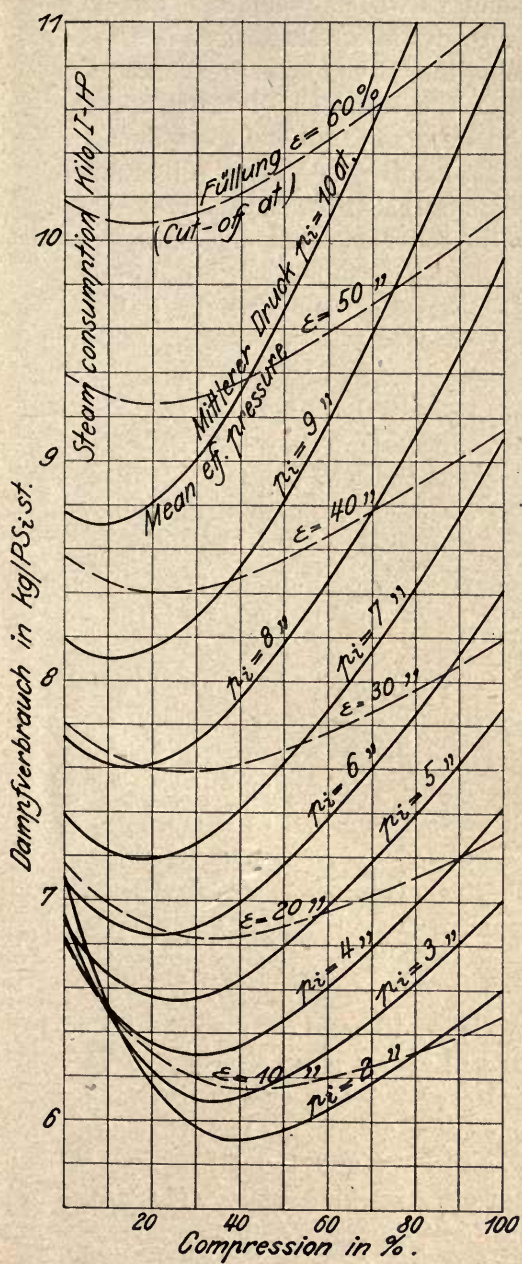


Fig. 10. Saturated steam 14 at. abs. Noncondensing, Clearance space 5%.

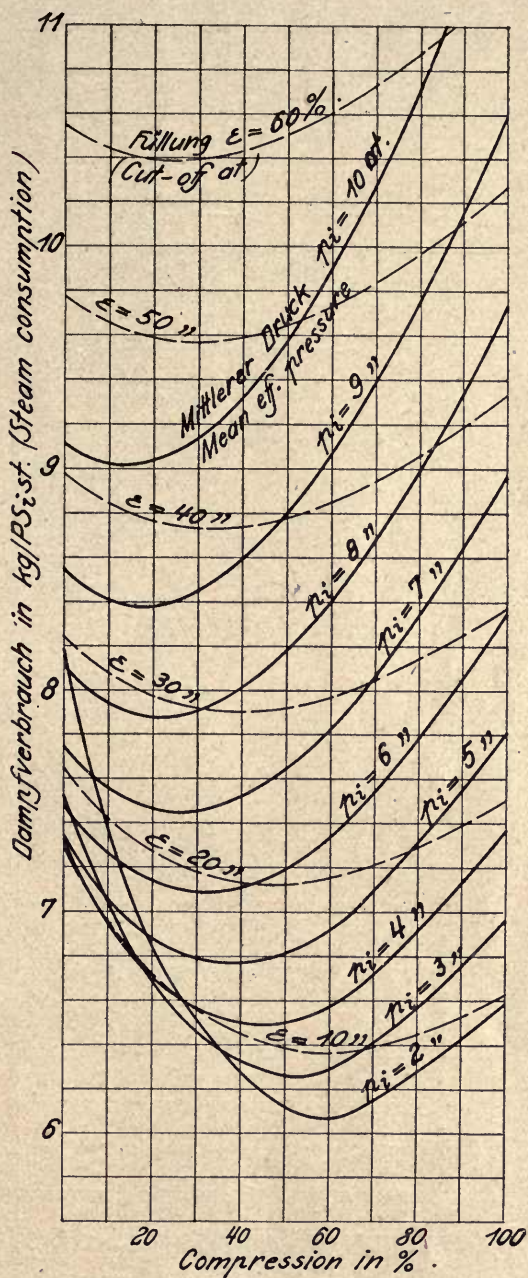


Fig. 11. Saturated steam 14 at. abs. Noncondensing, Clearance space 8%.

best economy is obtained with long compressions for early cut-offs  $\epsilon$  and small mean effective pressures  $p_i$  and vice versa. It will also be noticed that link valve gears and valve gears controlled by shaft governors acting upon both inlet and

exhaust have approximately correct variation of compression (Fig. 14). Valve gears operating with fixed compression can rightly be used in connection with small clearance volumes. Fig. 14 is

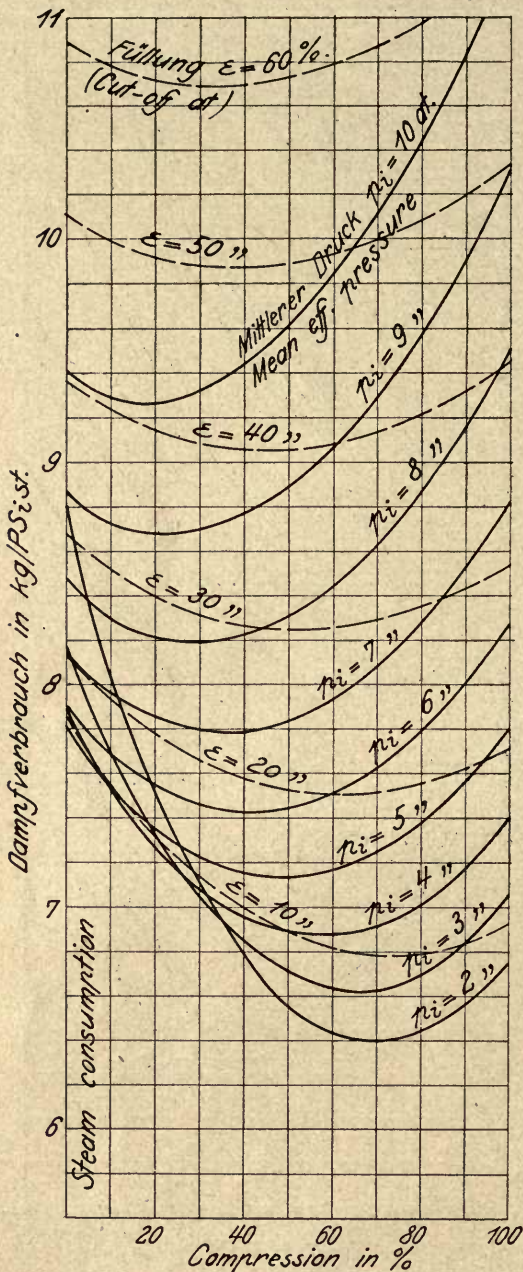


Fig. 12. Saturated steam 14 at. abs.  
Noncondensing, Clearance space 11%.

especially interesting, since it also contains the curve of compression obtained with the standard Walschaert gear of the German State Railways for an exhaust lap of  $-3\frac{1}{2}$  mm. It is surprising to find that this curve agrees closely with the calculated minimum values of the compression for constant M.E.P. The shortest cut-off of the link valve gear necessitates a large clearance volume, the bad effect of which is only partly neutralized by a correct variation of compression. It would be more important, however, considerably to reduce the clearance volume required by this type of gear, since the bad effect of large clearance volume far outweighs the correcting influence of the compression.

The best steam consumption for constant mean effective pressure  $p_i$  on the one hand, and constant cut-off  $\epsilon$  on the other, occur at different lengths of compression. If, as it must be,  $p_i$  is considered the governing variable, then shorter compressions are arrived at. The smaller the clearance volume is, the shorter will be the compressions at which both these minima occur.

Figs. 16 and 17 explain the different sets of curves more clearly. In Fig. 17 are repeated two curves from Fig. 15, one being a constant M.E.P. curve for  $p_i = 10$  at., and the other a constant cut-off curve for  $\epsilon = 50\%$ . The diagrams in Fig. 16 marked A (9% compression), and B (76% compression), have the same theoretical steam consumption of 8 kg/HP-hour, the cut-off being in both cases at 50% of the stroke. Dia-

gram C, also with a cut-off at 50% but with 47% length of compression, has a steam consumption of only 7.85 kg, while still another diagram D, having the same M.E.P. (10 at.) as diagram C, but with a cut-off at 44% and a

compression of 19%, only has a steam consumption of 7.6 kg. This last diagram is represented by the lowest point of the curve for constant M.E.P. (Fig. 17). At this point D, however, the constant M.E.P. curve is intersected

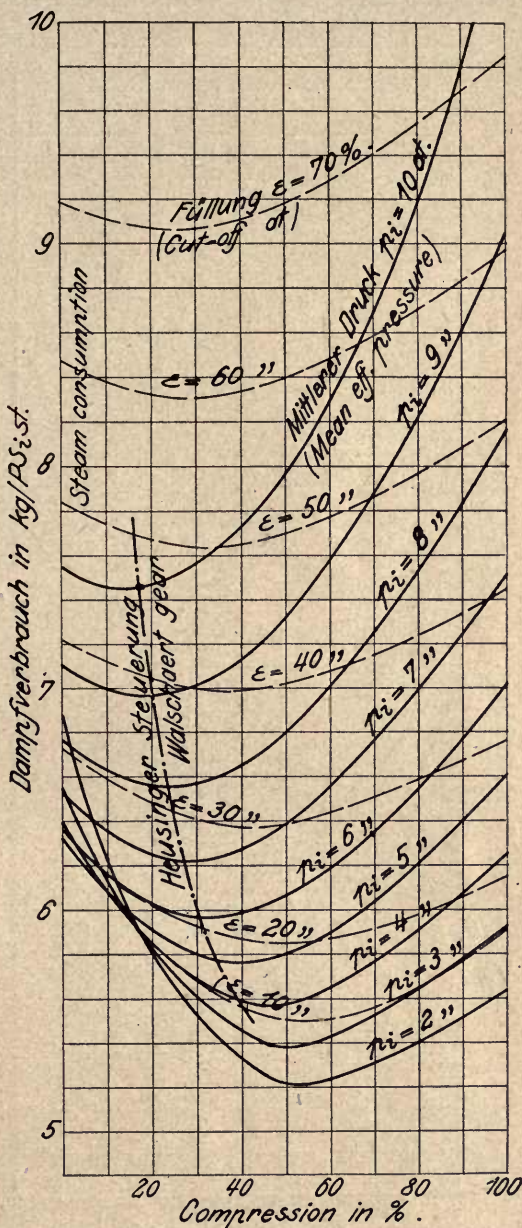
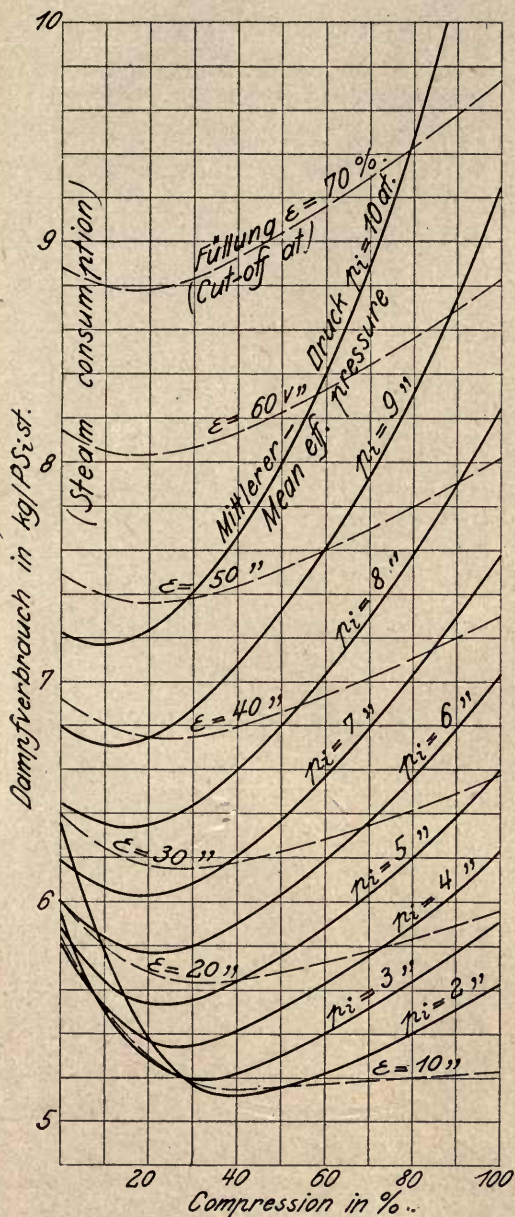


Fig. 13. Superheated steam 300° C, 14 at. abs. Noncondensing, Clearance space 5%.

Fig. 14. Superheated steam 300° C, 14 at. abs. Noncondensing, Clearance space 8%.

by a curve of constant cut-off at 44%. The lowest point of the latter in turn is intersected by another M.E.P. curve which also has a minimum. By following from minimum to minimum along the M.E.P. and cut-off curves a point is

finally reached at which the two minima coincide. This point represents a diagram with complete expansion and with compression to the initial pressure, a diagram which, as previously proved (Fig. 4), has no volume loss and gives the lowest theoretically possible steam consumption for the assumed range of pressures.

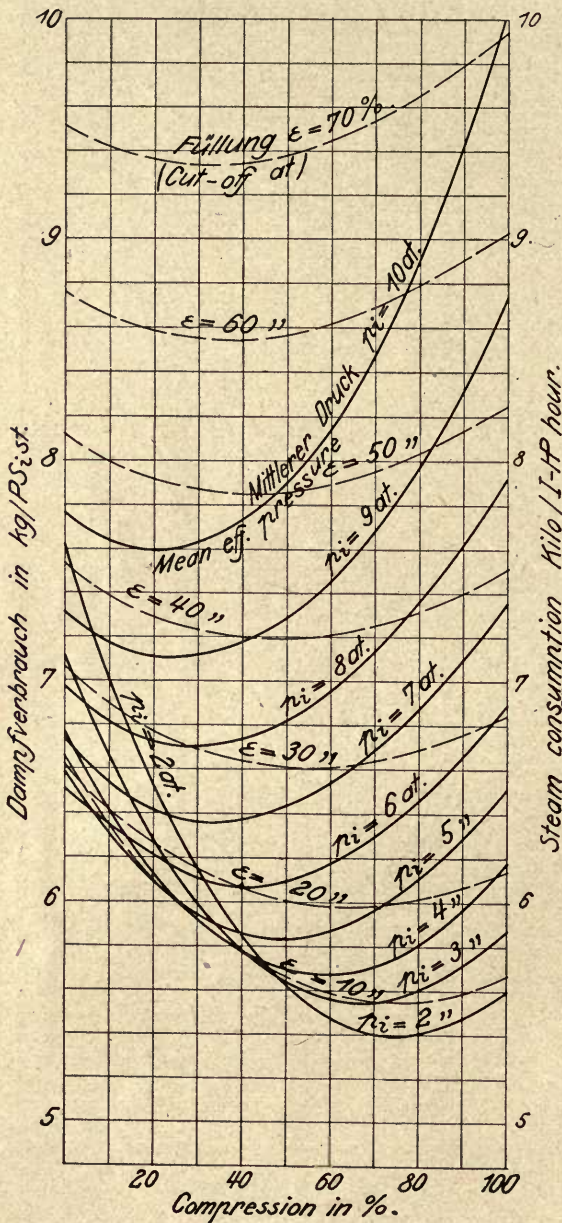


Fig. 15. Superheated steam 300° C, 14 at. abs. Noncondensing, Clearance space 11%.

Similar curves are shown in Fig. 18 for condensing operation. They refer to superheated steam of 13 at. abs., a steam temperature of 300° C, a back pressure of 0.08 at., and a clearance volume of 2%. In this diagram also the M.E.P. curves essentially determine the best compression.

For the M.E.P. of 2 to 3 at. ordinarily used it is evident that the best compression approximates 90% at this low back pressure, but even for considerably higher mean effective pressures the difference in steam consumption between 90% and the best compression is negligible. The difference gradually disappears as the back pressure approaches the absolute vacuum, since in this case compression naturally would have no influence whatever upon the steam consumption. Nevertheless, for 2% clearance, superheated steam of 13 at. abs. having a temperature of 300° C, an M.E.P. of 2,8 at., and a back pressure of 0.044 at. abs., the best compression is 90%. These may be considered average conditions for condensing una-flow engines.

*This proves conclusively that the long compression of the una-flow engine is in no way a necessary evil accompanying the use of piston-controlled exhaust ports.*

The flatness of the M.E.P. curves also indicates that it is permissible to keep the compression constant in the above case, which is a further argument for the correctness of the una-flow system.

*The long and constant compression of 90% of the condensing una-flow engine is therefore correct and admissible.*

Many authors discuss the "high compression" of the una-flow engine in the sense of its being unavoidable or undesirable. "High compression" is evidently confused with "long compression". A compression line may be long with low terminal pressure, or short with high terminal pressure. Generally speaking, terminal compression pressures are too low in the majority of condensing una-flow

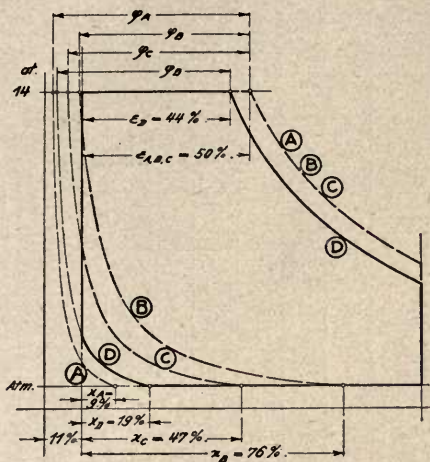


Fig. 16.

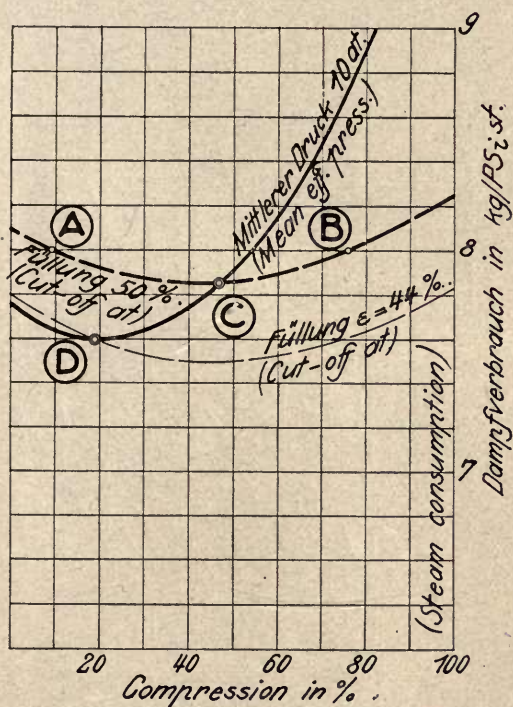


Fig. 17. Superheated steam 300° C, 14 at. abs. Noncondensing, Clearance space 11 %.

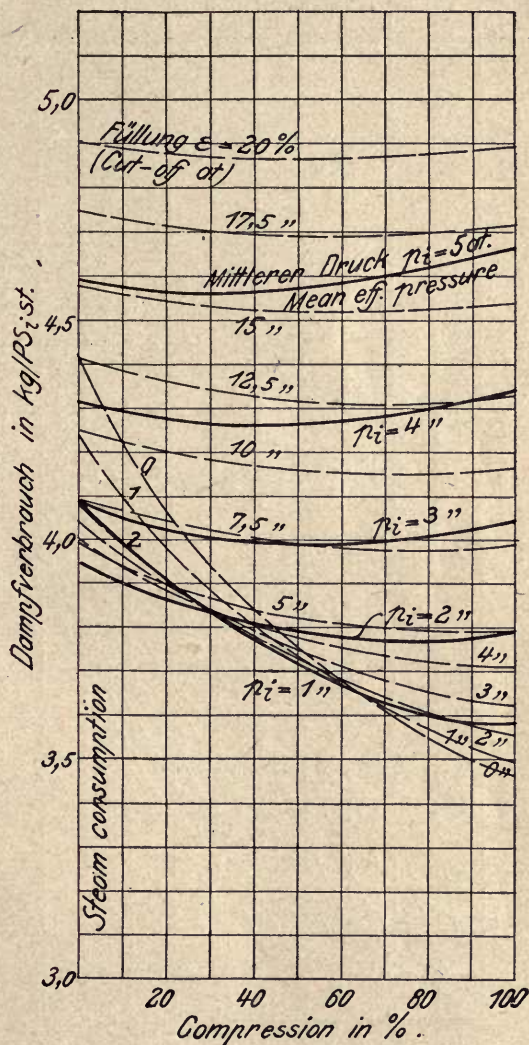


Fig. 18. Superheated steam 300° C, 14 at. abs. Condensing (0.08 at. abs.) Clearance space 2 %.

engines, and should be considerably higher according to paragraph 9 of the summary.

Steam consumption and compression curves for saturated steam, corresponding to those for superheated steam shown in Fig. 18, would show only a slight deviation from the latter, with the effect that the best compressions are slightly

shorter throughout. The assumption should, however, be remembered that expansion and compression are adiabatic and that the compression is thought to

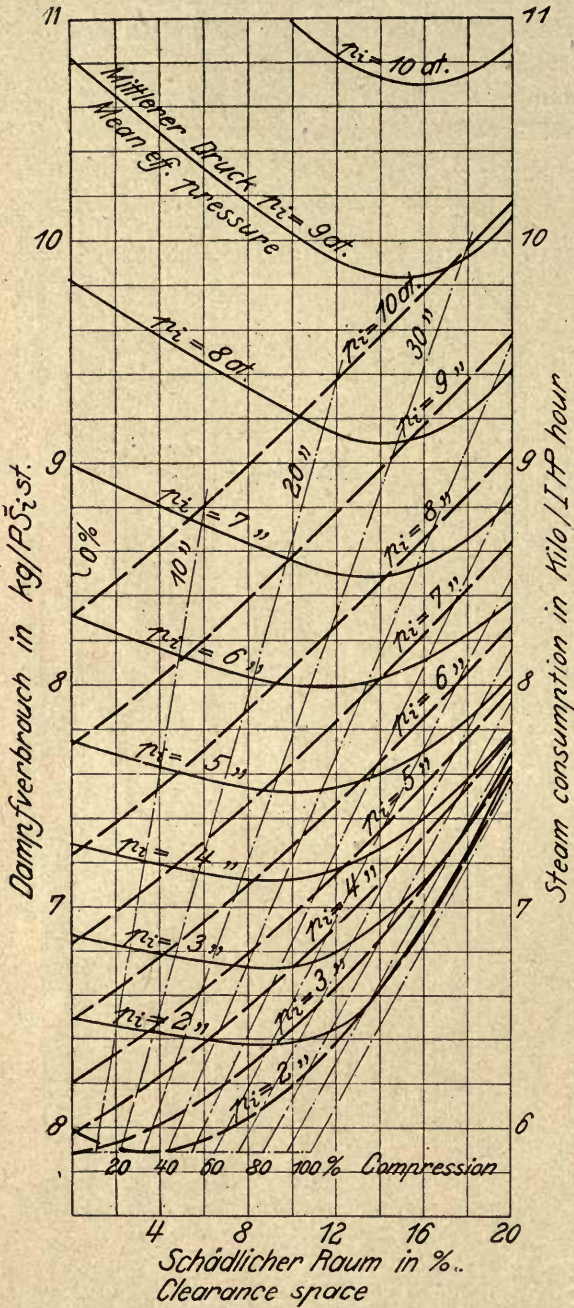


Fig. 19. Saturated steam 14 at. abs. Noncondensing.

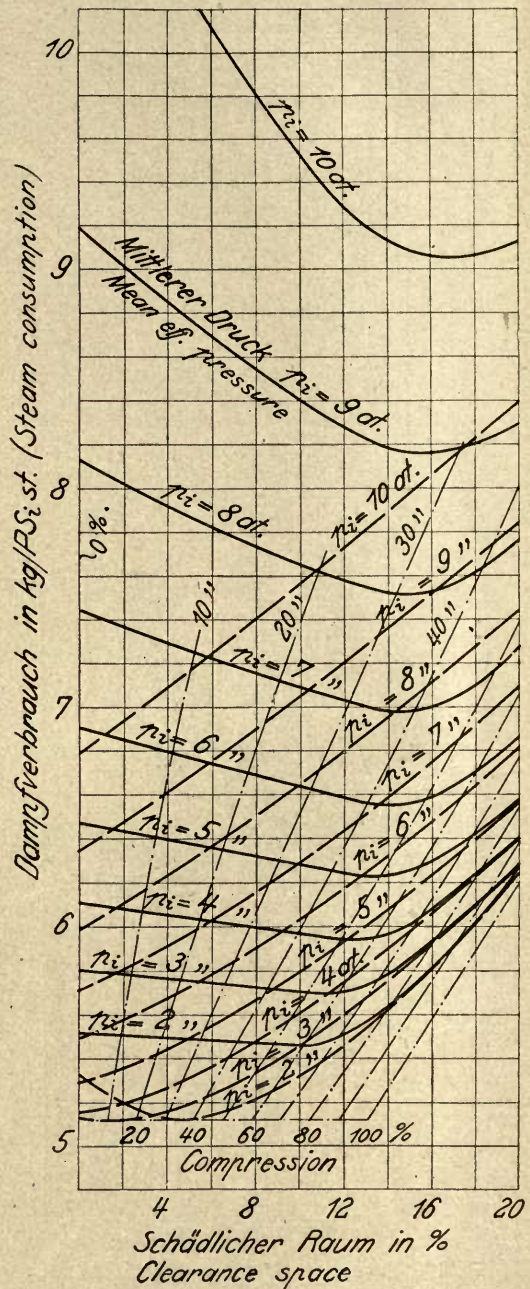


Fig. 20. Superheated steam 300° C, 14 at. abs. Noncondensing.

begin with the quality of steam resulting from continued adiabatic expansion during exhaust.

Jacketing of the cylinder, especially in una-flow engines, requires shorter compressions, since the effect of the jacket is to increase the temperature of the residual steam, thereby superheating it at an earlier stage and thus raising the compression line.

The heavy, full line curves in Fig. 19 give steam consumptions plotted against clearance volumes, for different mean effective pressures, a constant length of

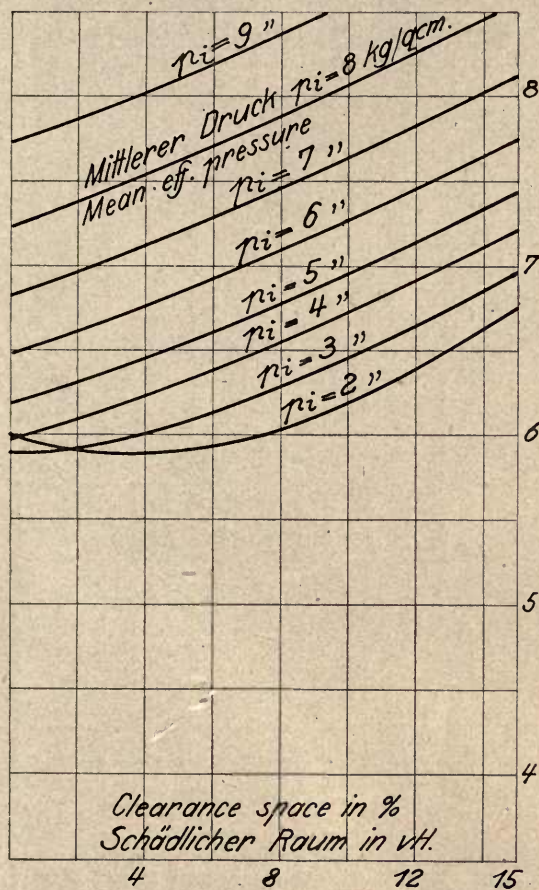


Fig. 21. Saturated steam 13 at. abs. Noncondensing.  
Most favourable compression.

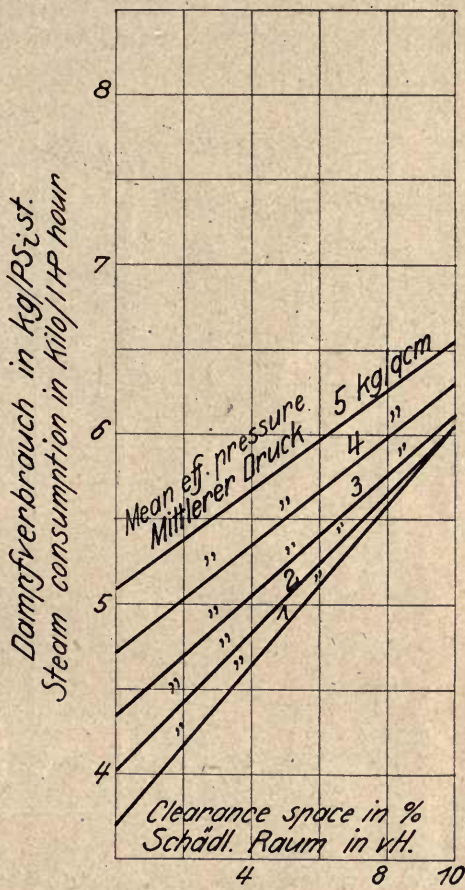


Fig. 22. Saturated steam 13 at. abs. Condensing (0.1 at. abs.).  
Most favourable compression.

compression of 90%, saturated steam at a pressure of 14 at. abs. and atmospheric exhaust. The heavy dashed line curves also give the theoretical steam consumptions plotted against clearance volumes for various mean effective pressures, but for the best compression in each case. The dashed-and-dotted lines are lines of constant best compression. The points of their intersection with the dashed lines give the best compression for that particular combination of M.E.P. and clearance volume.

For example, an M.E.P. of 10 at. requires a best compression of 20% for a clearance of 12%, the steam consumption being 9.4 kg. Also for 6% clearance,

an M.E.P. of 10 at., and a best compression of 10%, the steam consumption would be 8,8 kg.

Fig. 20 shows similar curves for superheated steam of 14 at. abs., a temperature of 300° C and atmospheric exhaust.

It should be observed that in Figs. 19 and 20 the dashed curves for an M.E.P. of 2 at. show a distinct minimum. At this point the expansion reaches the back pressure. Reduction of the clearance volume beyond the point indicated by the minimum of the M.E.P. curve, for a constant M.E.P. of 2 at., results in a loop on the indicator card with a corresponding increase in steam consumption.

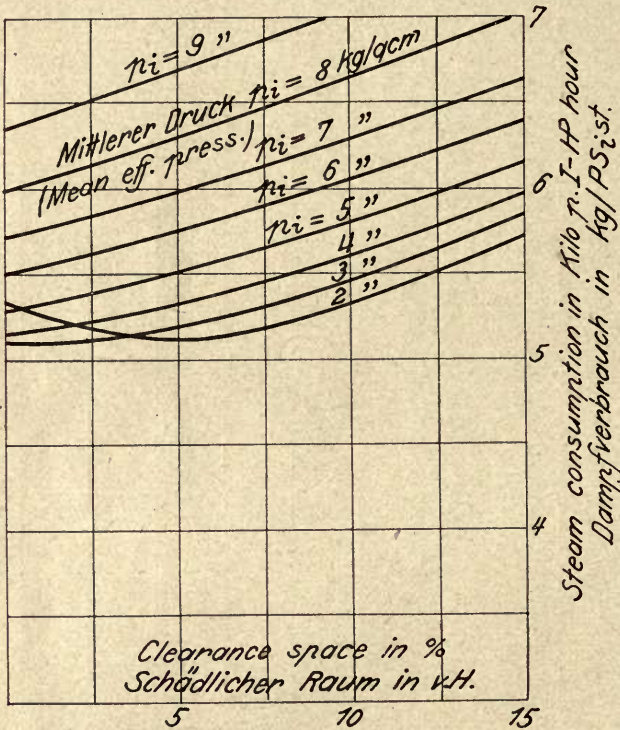


Fig. 23. Superheated steam 300° C, 13 at. abs. Noncondensing. Most favourable compression.

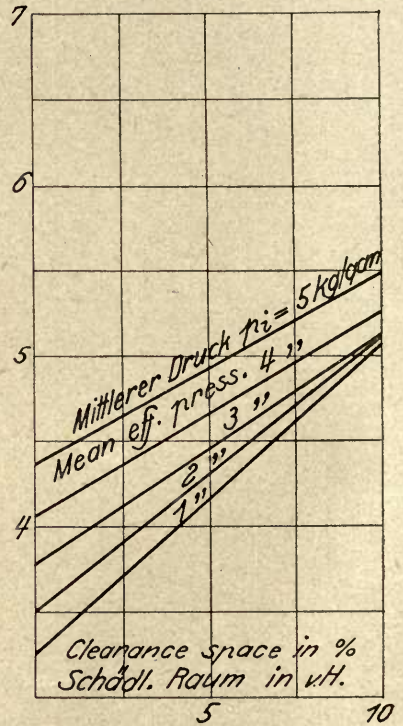


Fig. 24. Superheated steam 300° C, 13 at. abs. Condensing (0.1 at. abs.) Most favourable compression.

The dashed curves of Fig. 19 are repeated in Fig. 21. They give steam consumptions for different mean effective pressures plotted against clearance volumes, for saturated steam of 13 at. abs., atmospheric exhaust and best compression in each case.

Fig. 22 shows similar curves for a back pressure of 0.1 at. abs.

Figs. 23 and 24 show corresponding curves for superheated steam of 14 at. abs. and a temperature of 300° C, Fig. 23 being for atmospheric exhaust and Fig. 24 for condensing operation (back pressure 0.1 at. abs.).

Apart from the curves for low mean effective pressures it is interesting to note that for atmospheric exhaust the steam consumption shows an almost linear



dependence upon the clearance, the best compression being assumed in each case. It is therefore possible to calculate the mean specific volume loss per 1% clearance and per HP-hour. For dry saturated steam of 14 at. abs., this is found to be 0.0918 kg/HP-hour and 1% clearance for atmospheric exhaust, and 0.1715 kg. HP-hour and 1% clearance, for condensing operation. The corresponding figures for the mean specific volume loss for superheated steam of 14 at. abs. and a temperature of 300° C are 0.072 kg for atmospheric exhaust, and 0.12 kg for condensing operation. For instance in the case of a single cylinder condensing engine running on saturated steam, an increase in clearance volume of 6% will raise the steam consumption by 1 kg/HP-hour.

The curves of Figs. 21, 22, 23, 24 also contain the steam consumption of the ideal engine without clearance, which is given by the intersection of the M.E.P. curves with the zero clearance line. The distance of a horizontal line drawn through such points from the corresponding M.E.P. curves gives the volume loss for any particular clearance. It may therefore be stated that *for the same initial and back pressure, the same M.E.P. and best compression, the theoretical steam consumption and the volume loss increase almost linearly with the clearance volume.* Excluding small clearances and mean effective pressures, this relation is strictly true for condensing operation and approximately so for atmospheric exhaust.

A mathematical expression of the volume loss  $R$  can be based on the difference in area of the diagrams with and without clearance, for  $\varphi = \text{constant}$  (see shaded areas in Figs. 1, 2, 3);  $i_e, p_e, i_{e2}$  and  $p_{e2}$  representing the total heat and pressure at the end of expansion, where index 1 refers to the engine without, and index 2 to the engine with clearance. The stroke volume is again assumed to be 1 cbm. Expansion and compression are adiabatic.

1. Arbitrary length of compression (counterflow engines):

$$R = 427 (i_1 - i_{e1}) \gamma_1 \varphi + 10000 (p_{e1} - p_2) - 427 (i_1 - i_{e1}) \gamma_1 (\varphi + V_c) - \\ - 10000 (p_{e1} - p_e) (1 + S_0) + 10000 p_2 (1 - k) + 427 (i_k - i_2) \gamma_2 (k + S_0) + \\ + 10000 (p_1 - p_k) S_0 \dots \dots \dots \text{(VII)}$$

All values may be taken from the Mollier chart, with the assumptions that the quality of the steam at the beginning of compression is equal to the quality obtained by expanding adiabatically to the back pressure, and that the specific volume of the residual steam reduced to initial pressure is equal to the specific volume obtained by continuing the compression adiabatically from the terminal compression to the initial pressure.

For an approximate calculation with almost exact results, it may be assumed that  $i_{e1} = i_{e2}$  and  $p_{e1} = p_{e2}$ , or approximately:

$$R = 10000 p_2 (1 - k) + 427 (i_k - i_2) \cdot \gamma_2 (k + S_0) + 10000 (p_1 - p_k) S_0 - \\ - 427 (i_1 - i_{e1}) \gamma_1 \cdot V_c - 10000 (p_{e1} - p_2) S_0 \dots \dots \dots \text{(VIII)}$$

2. 100% length of compression (una-flow engines):

$$R = 427 (i_1 - i_{e1}) \gamma_1 \cdot \varphi + 10000 (p_{e1} - p_2) - 427 (i_1 - i_{e1}) \gamma_1 (\varphi + V_c) - \\ - 10000 (p_{e1} - p_2) (1 + S_0) + 427 (i_k - i_2) \gamma_2 (1 + S_0) + 10000 (p_1 - p_k) S_0 \text{ (IX)}$$

Again, for approximate results it may be assumed that  $i_{e1} = i_{e2}$  and  $p_{e1} = p_{e2}$ , or approximately:

$$R = 427 (i_k - i_2) \gamma_2 (1 + S_0) + 10000 (p_1 - p_k) S_0 - 427 (i_1 - i_{e1}) \gamma_1 V_c - 10000 (p_{e1} - p_2) S_0 \dots \dots \dots (X)$$

$V_c$  may be taken directly from the Mollier chart. The result  $R$  of this calculation is the *absolute volume loss* per stroke in a cylinder having a clearance volume of  $S_0$ , a stroke of 1 m and an area of 1 sqm. For different cylinder sizes  $R$  has to be changed proportionately. The HP loss may be obtained by multiplying  $R$  by the revolutions per second and dividing by 75.

The quotient  $\frac{R}{L_i}$  can be termed "relative volume loss", wherein

$$L_i = 427 (i_1 - i_e) \cdot \gamma_1 \varphi + 10000 (p_{e1} - p_2) \dots \dots \dots (XI)$$

and is the output per stroke in mkg of a cylinder of 1 cbm stroke volume, without clearance.

For a cylinder, with clearance, of 1 cbm stroke volume, the output per stroke in mkg would be

$$L_i = 427 (i_1 - i_{e1}) \gamma_1 (\varphi + V_c) + 10000 (p_{e1} - p_2) (1 + S_0) - 10000 p_2 (1 - k) - 427 (i_k - i_2) \gamma_2 (k + S_0) - 10000 (p_1 - p_k) S_0 \dots \dots \dots (XII)$$

This calculation gives the relative volume loss for una-flow engines having 100% compression and 95% vacuum, referred to the output per stroke of an ideal engine without clearance. This relative volume loss is almost independent of the initial pressure.

For initial pressures of 8 to 15 at. abs., this gives

for a clearance of 1%,	a mean relative volume loss of	5%
" " " " 2%,	" " " " " "	6%
" " " " 3%,	" " " " " "	8½%
" " " " 4%,	" " " " " "	11½%
" " " " 5%,	" " " " " "	14%
" " " " 7%,	" " " " " "	21%
" " " " 9%,	" " " " " "	27%.

These figures also show an approximately linear relation between volume loss and clearance volume, except for very small clearances.

As a final result of the foregoing discussions, Fig. 25 shows a simple rule which allows the best compression to be determined for any given case. For a given amount of steam  $\varphi$  the compression must evidently be correct if a displacement of the line  $\varphi$  by an amount  $d\varphi$  produces equal changes of area, shown shaded in Fig. 25, on both the expansion and compression sides of the diagram, in such a way that the following equation is satisfied:

$$427 (i_1 - i_e) \cdot d\varphi \cdot \gamma_1 = 427 (i_k - i_2) d\varphi \cdot \gamma_1 \quad \text{or: } i_1 - i_e = i_k - i_2 \dots \dots (XIII)$$

or in other words the change of total heat during expansion is equal to the change of total heat during compression. It is therefore only necessary to add the change of total heat during expansion to the total heat corresponding to the back pressure, in order to obtain the best terminal compression pressure. By laying out the corresponding compression line, the best length of compression will be determined.

It again follows that for 100% cut-off the compression is zero, and for expansion to the back pressure the compression must reach the initial pressure.

The following fundamental law therefore applies: *For given initial pressure, back pressure, mean effective pressure and clearance volume, the length of compression must be such that the change of total heat during expansion is equal to the change of total heat during compression.*

Interchanging the words "back pressure" and "length of compression" with each other again leads to equality of heat change. In other words, *for a given initial pressure, mean effective pressure, clearance volume and length of compression, the back pressure must be such that the change of total heat during expansion is equal to the change of total heat during compression.*

Starting with a diagram of equal heat changes, a reduction in back pressure, with the same clearance and the same length of compression, produces a smaller heat change during compression (see Mollier chart), and for the same initial pressure and M.E.P., a larger heat change during expansion, with the result of an increase in steam consumption. An increase in back pressure under the same assumptions produces inverse heat changes and also increases the steam consumption. The inherent change in steam consumption caused by a reduction in back pressure is an entirely separate consideration.

An interchange of the words "initial pressure" and "back pressure" again leads to equality of total heat changes, or in other words, *for a given back pressure, mean effective pressure, clearance volume and length of compression, the initial pressure must be such that the change of total heat during expansion is equal to the change of total heat during compression.*

Starting again with a diagram of equal heat changes, a reduction in initial pressure also reduces the change of total heat during expansion for the same length of compression and the same back and mean effective pressures. Inversely, an increase in initial pressure will also increase the heat change during expansion. The heat change during compression still being the same, an increase in steam consumption will result on account of the inequality of the heat changes. The variation of steam consumption due to a change in initial pressure alone is a point to be considered separately.

The wording of the last two forms of this fundamental law has particular reference to compound and triple or quadruple-expansion engines. For instance, a variation of cut-off in the low pressure cylinder of a compound engine affects the exhaust pressure of the high pressure cylinder as well as the admission pressure of the low pressure cylinder, and renders possible an even distribution of heat changes in both cylinders.

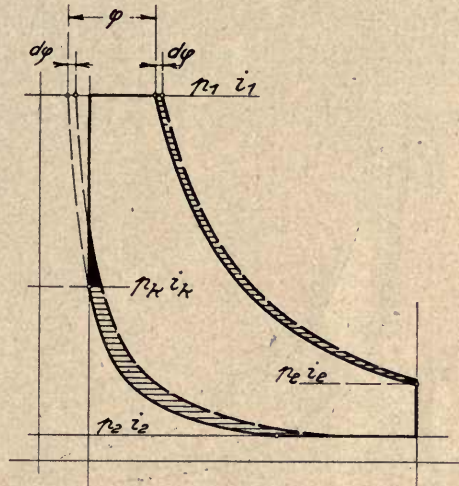


Fig. 25.

Considering the high and low pressure diagrams as one, this leads to equal changes of total heat during the combined expansion and compression, i. e. equal heat changes in each part diagram result in equal heat changes in the combined diagram.

The same reasoning applies to triple and quadruple-expansion engines.

A different problem is presented by the determination of the best clearance volume for a given M.E.P. and given length of compression. This would apply especially to una-flow engines where the length of compression is fixed.

The heavy lines in Figs. 19 and 20 correspond to constant compression (90%), and intersect the dashed lines, these intersections being located on the dashed-and-dotted line corresponding to a best compression of 90%. Each intersection refers to a definite clearance volume and mean effective pressure for which combination 90% compression is the best. The heavy lines indicate that with a constant compression of 90% the steam consumption can be diminished by reducing the clearance. Referring to Fig. 20, and taking for instance, the dashed curve for  $p_i = 2$  at. representing steam consumption with best compression, it will be found that for 17% clearance the best compression is 90%. Following the full line curve for  $p_i = 2$  at., passing through this point, a clearance volume of 10% is found to give the lowest steam consumption with 90% compression and this mean effective pressure. It is ob-

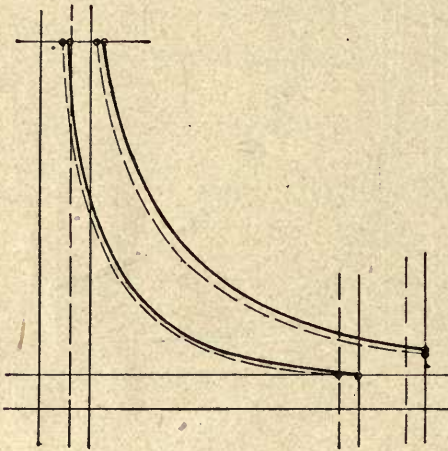


Fig. 26.

vious that at this point the heat changes during expansion and compression are not equal, since this occurred for a clearance volume of 17%.

The rule for determining the best clearance volume for a given M.E.P. and length of compression can be arrived at by the following reasoning.

The full line diagram in Fig. 26 is assumed to have equal heat changes during expansion and compression. It is then possible to increase the area of the diagram by transposing the lines bounding the stroke volume towards the left, the points of cut-off and compression remaining fixed. On account of this transposition, the new diagram has a slightly longer compression. A reduction of the length of compression in the new diagram to the original value will diminish the pressure change during compression, and, for the same amount of steam admitted also increase the pressure change during expansion; the diagram area still remaining increased. Repeating this procedure, the point of best clearance volume is approached, for which the changes of total heat during compression and expansion are equal. This theorem has been proved here for a given constant quantity of steam admitted. Since it is the same problem whether the maximum M.E.P. is required for a given quantity of steam admitted, or the maximum quantity of steam for a given M.E.P., the rule may be stated thus: *for given initial pressure, back pressure, mean effective pressure and length of compression, the clearance*

volume must be such that the pressure change during expansion is equal to the pressure change during compression. Under certain conditions, therefore, an increase in clearance volume may cause a reduction in steam consumption. Nearly all un-flow engines violate this rule. The majority of condensing engines have too large, and non-condensing engines too small a clearance volume. Referring to Fig. 27, and starting as before with equality of changes of total heat, then for the same terminal expansion and compression pressure and different clearance volumes it follows that, approximately,

$$\frac{s_1}{s_1 + k_1} = \frac{s_2}{s_2 + k_2} = \frac{V_K}{V_2} \quad \text{OR} \quad s_1 s_2 + s_1 k_2 = s_2 s_1 + s_2 k_1 \quad \text{OR} \quad \frac{s_1}{s_2} = \frac{k_1}{k_2} \quad (\text{XIV})$$

This means that for the same initial and back pressure, the same terminal expansion and compression pressure, and equality of heat changes during expansion and compression, the lengths of the best compressions have the same ratio as the clearance volumes.

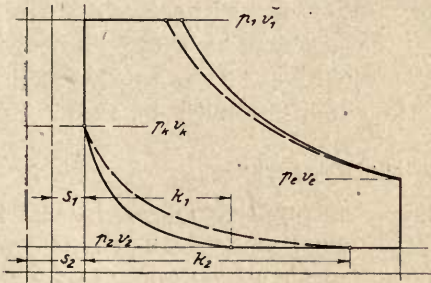


Fig. 27.

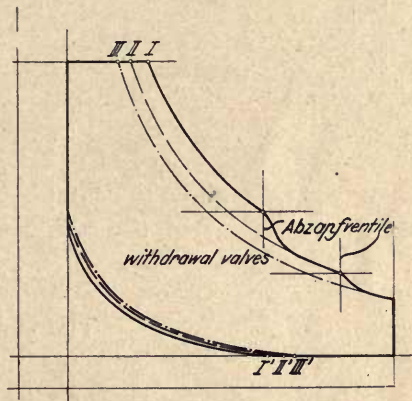


Fig. 28.

A withdrawal of steam during expansion necessarily changes the length of compression. As will be shown later, un-flow engines permit the bleeding of steam during expansion. One or two withdrawals according to Fig. 28 will shift the beginning of compression from I' to II' or III'. The same effect will be produced by an increase in exhaust lead.

Finally, a comparison of Figs. 29 and 30 shows the favorable manner in which compounding influences the volume loss. The diagram of Fig. 29 has the same clearance volume as the low pressure cylinder in Fig. 30. The comparison reveals the fact that the volume loss of the low pressure part of both diagrams is about the same, but that for the high pressure part the compound diagram shows a decidedly smaller volume loss. It should not be overlooked, however, that the un-flow diagram can be realized in a cylinder with only 1% clearance (single beat valves), while low pressure cylinders of ordinary design have a clearance of about 6% or more.

Fig. 30 further indicates that the greatest part of the volume loss in compound engines occurs in the low pressure cylinder, and comparatively little in the high pressure cylinder.

Cylinder jacketing in un-flow engines causes a considerably steeper compression line as well as higher expansion line, which must be compensated for

by shortening the length of compression. Leaky inlet valves will have the same effect. Leaky exhaust valves, however, would require longer compression to compensate for the resultant change in the expansion and compression lines.

The maximum volume loss occurs when the admission is longer than the compression, and part of the clearance volume is arranged on the cylinder at a point between end of admission and beginning of compression, because under these conditions the compression is unable to correct the losses due to this clearance.

Decrease of this clearance volume loss occurs, if the clearance space is placed nearer to the inlet end of the cylinder as regards the compression part of the stroke but nearer to the exhaust end of the cylinder as regards the expansion part of the stroke.

Decrease of this clearance volume loss occurs, if the clearance space is placed nearer to the inlet end of the cylinder as regards the compression part of the stroke but nearer to the exhaust end of the cylinder as regards the expansion part of the stroke.

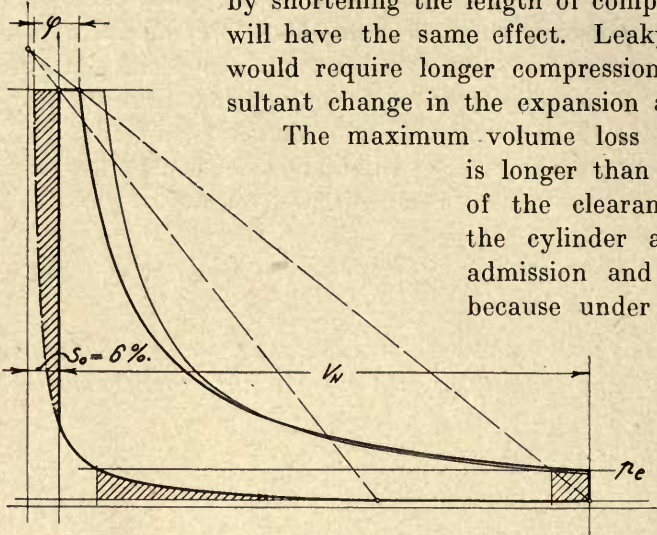


Fig. 29.

**Critical Back Pressure.**

The shape of the steam consumption curves in Fig. 18 indicates that under certain conditions a length of compression in excess of 100% is the most favorable. In a steam cylinder, however, only compressions up to approximately 100% can be realized. A best compression of 120% therefore would mean a rise in back pressure corresponding to 20% compression previous to the commencement of the cylinder compression of 100%. This increase in back pressure could

be obtained by some kind of throttling organ in the exhaust pipe or in the cooling water pipe or by admitting air into the condenser.

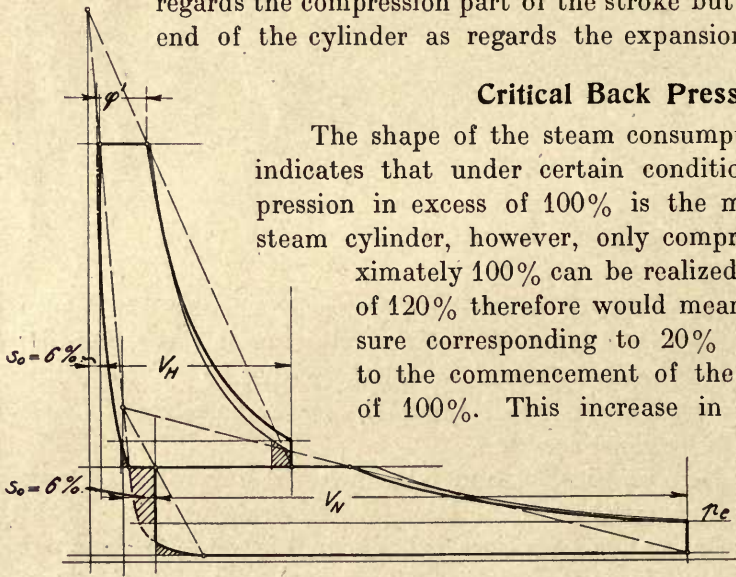


Fig. 30.

In other words, if this higher back pressure is not in effect, the compression remains at 100% with a resultant increase in steam consumption due to wrong length of compression. If now the back pressure is raised an amount corresponding to 20% compression, this back pressure would be the best for 100% compression. A further increase of the back pressure beyond this point would result in an increased steam consumption for 100% compression. This leads to the conception of the term "critical back pressure". *The critical back pressure, therefore, is that value of the back pressure at the beginning of compression, the*

increase or decrease of which for the same length of compression, the same clearance volume, the same mean effective pressure and the same initial pressure, results in an increased steam consumption. Fig. 18 shows the effect of the compression, and Fig. 31 the effect of the output (mean effective pressure) upon the critical back pressure.

Fig. 31 gives the theoretical steam consumption for 90% compression plotted against the back pressure. All three curves slope towards the right, i. e., the steam consumption diminishes with increasing back pressure. Throttling of the exhaust or partial reduction of the vacuum would thus reduce the steam consumption. The critical back pressure, therefore, has been exceeded in all three cases. At the same time the influence of the output can be quite clearly seen, since the slope of the curves for early cut-offs is more pronounced than it is for the others. The critical back pressures will be reached when these curves

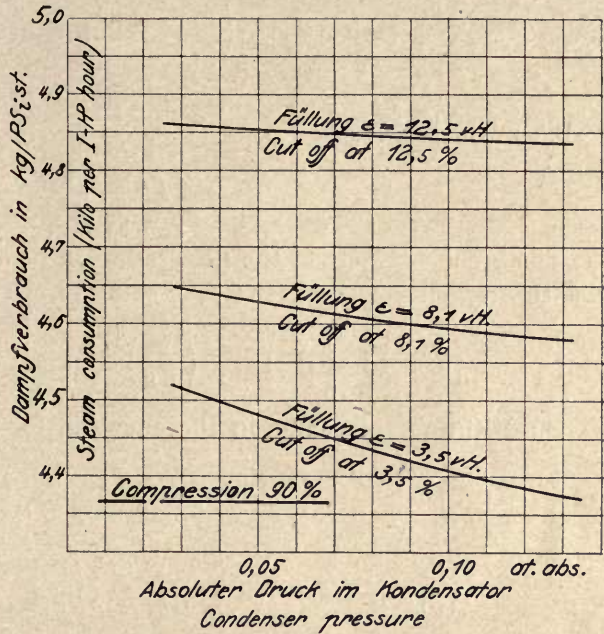


Fig. 31. Superheated steam 300° C, 13 at. abs. Clearance space 5%.

attain their lowest points and reverse their slope. The uppermost curve will reach its minimum sooner than the lower curves; or in other words, *the critical back pressure is the higher, the lower the output (MEP)*.

The starting point for the calculation of the critical back pressure, according to the above, is not the cut-off but rather the output or MEP.; or, for given initial pressure, clearance volume and length of compression, the amount of steam admitted is the basis. According to Fig. 5, and referring to page 18, the reciprocal of the value of the steam consumption for adiabatic expansion and compression ( $p v^{1,33} = \text{const.}$ ) is:

$$\theta = \frac{p_1 (V_E - S_0) + \frac{p_1 \cdot V_E^n}{1-n} (V_H^{1-n} - V_E^{1-n}) - \frac{p_2 V_K^n}{1-n} (V_K^{1-n} - S_0^{1-n}) - p_2 (V_H - V_K)}{\varphi}$$

$$\theta = \frac{p_1}{\varphi} (V_E - S_0) + \frac{p_1}{\varphi} \cdot \frac{V_E}{n-1} \left[ 1 - \left( \frac{V_E}{V_H} \right)^{n-1} \right] - \frac{p_2}{p_1} \cdot \frac{p_1}{\varphi} \cdot \frac{V_K}{n-1} \left[ \left( \frac{V_K}{S_0} \right)^{n-1} - 1 \right] - \frac{p_2}{p_1} \cdot \frac{p_1}{\varphi} (V_H - V_K)$$

$$\Theta = \frac{p_1}{\varphi} V_E - \frac{p_1}{\varphi} S_0 + \frac{p_1}{\varphi} \cdot \frac{V_E}{n-1} - \frac{p_1}{\varphi} \frac{V_E^n}{(n-1) V_H^{n-1}} - \frac{p_2}{p_1} \cdot \frac{p_1}{\varphi} \frac{V_K^n}{(n-1) S_0^{n-1}} +$$

$$+ \frac{p_2}{p_1} \cdot \frac{p_1}{\varphi} \frac{V_K}{n-1} - \frac{p_2}{p_1} \cdot \frac{p_1}{\varphi} V_H + \frac{p_2}{p_1} \cdot \frac{p_1}{\varphi} \cdot V_K.$$

Now  $V_E = \varphi + V_c = \varphi + V_K \left( \frac{p_2}{p_1} \right)^{\frac{1}{n}}$ ; Substituting this in the equation for  $\Theta$ ,

$$\Theta = p_1 + \left( \frac{p_2}{p_1} \right)^{\frac{1}{n}} \cdot \frac{p_1}{\varphi} \frac{V_K \cdot n}{n-1} - \frac{p_1}{\varphi} S_0 + \frac{p_1}{n-1} - \frac{p_1}{n-1} \cdot \frac{V_K^n}{(n-1) V_H^{n-1}} \left( \frac{\varphi}{V_K} + \left( \frac{p_2}{p_1} \right)^{\frac{1}{n}} \right)^n -$$

$$- \frac{p_2}{p_1} \frac{p_1}{\varphi} \frac{V_K^n}{(n-1) S_0^{n-1}} + \frac{p_2}{p_1} \cdot \frac{p_1}{\varphi} \cdot \frac{V_K \cdot n}{n-1} - \frac{p_2}{p_1} \frac{p_1}{\varphi} V_H.$$

The bracketed part of the fifth term can be expressed as a series by the binomial theorem; considering the first three terms only, the expansion gives:

$$\left( \frac{\varphi}{V_K} + \left( \frac{p_2}{p_1} \right)^{\frac{1}{n}} \right)^n = \left( \frac{\varphi}{V_K} \right)^n + n \left( \frac{\varphi}{V_K} \right)^{n-1} \cdot \left( \frac{p_2}{p_1} \right)^{\frac{1}{n}} + \frac{n(n-1)}{1 \cdot 2} \left( \frac{\varphi}{V_K} \right)^{n-2} \left( \frac{p_2}{p_1} \right)^{\frac{2}{n}}.$$

Substituting this value in the equation for  $\Theta$ ,

$$\Theta = p_1 + \left( \frac{p_2}{p_1} \right)^{\frac{1}{n}} \cdot \frac{p_1}{\varphi} \frac{V_K \cdot n}{n-1} - \frac{p_1}{\varphi} S_0 + \frac{p_1}{n-1} - \frac{p_1}{n-1} \left( \frac{\varphi}{V_H} \right)^{n-1} -$$

$$- \left( \frac{p_2}{p_1} \right)^{\frac{1}{n}} \frac{n}{n-1} p_1 \frac{V_K}{\varphi} \left( \frac{\varphi}{V_H} \right)^{n-1} - \left( \frac{p_2}{p_1} \right)^{\frac{2}{n}} \frac{n}{2} p_1 \left( \frac{V_K}{\varphi} \right)^2 \left( \frac{\varphi}{V_H} \right)^{n-1} -$$

$$- \frac{p_2}{p_1} \cdot \frac{p_1}{\varphi} \frac{V_K^n}{(n-1) S_0^{n-1}} + \frac{p_2}{p_1} \cdot \frac{p_1}{\varphi} V_K \frac{n}{n-1} - \frac{p_2}{p_1} \cdot \frac{p_1}{\varphi} V_H.$$

If the steam consumption is to be a minimum or  $\Theta$  a maximum, it follows that

$$\frac{d\Theta}{d\left(\frac{p_2}{p_1}\right)} = 0.$$

Then

$$\frac{d\Theta}{d\left(\frac{p_2}{p_1}\right)} = \left( \frac{p_2}{p_1} \right)^{\frac{1-n}{n}} \cdot \frac{p_1}{\varphi} \frac{V_K}{n-1} - \left( \frac{p_2}{p_1} \right)^{\frac{1-n}{n}} \cdot \frac{p_1}{(n-1)\varphi} \frac{V_K}{\left( \frac{\varphi}{V_H} \right)^{n-1}} -$$

$$- \left( \frac{p_2}{p_1} \right)^{\frac{2-n}{n}} p_1 \left( \frac{V_K}{\varphi} \right)^2 \cdot \left( \frac{\varphi}{V_H} \right)^{n-1} - \frac{p_1}{\varphi} \frac{V_K^n}{(n-1) S_0^{n-1}} + \frac{p_1}{\varphi} V_K \frac{n}{n-1} - \frac{p_1}{\varphi} V_H = 0.$$

or

$$\left( \frac{p_2}{p_1} \right)^{\frac{1-n}{n}} \left[ 1 - \left( \frac{\varphi}{V_H} \right)^{n-1} \right] - \left( \frac{p_2}{p_1} \right)^{\frac{2-n}{n}} \frac{V_K}{\varphi} (n-1) \left( \frac{\varphi}{V_H} \right)^{n-1} - \left[ \left( \frac{V_K}{S_0} \right)^{n-1} + \frac{V_H}{V_K} (n-1) - n \right] = 0$$

.... (XV)

If  $V_H = V_K$  i. e. for 100% length of compression (una-flow engines), this formula simplifies to:

$$\left( \frac{p_2}{p_1} \right)^{\frac{1-n}{n}} \left[ 1 - \left( \frac{\varphi}{V_H} \right)^{n-1} \right] - \left( \frac{p_2}{p_1} \right)^{\frac{2-n}{n}} (n-1) \left( \frac{\varphi}{V_H} \right)^{n-2} - \left[ \left( \frac{V_H}{S_0} \right)^{n-1} - 1 \right] = 0 \quad \text{(XVI)}$$



Substituting in these equations  $\left(\frac{p_2}{p_1}\right)^{\frac{1-n}{n}} = \frac{1}{x}$  and  $n = 1,33$  or  $\frac{4}{3}$ , then

$$x = \left(\frac{p_2}{p_1}\right)^{\frac{n-1}{n}} \quad \text{or} \quad x^{\frac{1}{n-1}} = \left(\frac{p_2}{p_1}\right)^{\frac{1}{n}}.$$

Therefore  $\left(\frac{p_2}{p_1}\right)^{\frac{2-n}{n}} = x^{-1} \cdot \left(\frac{p_2}{p_1}\right)^{\frac{1}{n}} = x^{-1} \cdot x^{\frac{1}{n-1}} = x^{\frac{2-n}{n-1}} = x^{\frac{2-1,33}{1,33-1}} = x^2$ .

Hence equation (XV) can be expressed in the form:  $\frac{b}{x} - ax^2 - c = 0$   
 or  $x^3 + \frac{c}{a}x - \frac{b}{a} = 0$ .

This cubic equation may be written  $x^3 + px + q = 0$  where  $p = \frac{c}{a}$  and  $q = -\frac{b}{a}$ , and may be solved by Cardani's formula as follows:

$$x = \sqrt[3]{-\frac{1}{2}q + \sqrt{\left(\frac{1}{2}q\right)^2 + \left(\frac{1}{3}p\right)^3}} + \sqrt[3]{-\frac{1}{2}q - \sqrt{\left(\frac{1}{2}q\right)^2 + \left(\frac{1}{3}p\right)^3}} \quad (\text{XVII})$$

With the help of equations XV, XVI and XVII, the critical back pressures  $p_2$  have been figured for various initial pressures, clearance volumes, lengths of compression, and amounts of admitted steam. The results are plotted in Figs. 32, 33, 34 and 35, and show the influence of these different variables upon the critical back pressure.

Fig. 32 gives the variation of the critical back pressure for different clearance volumes and initial pressures, for a constant amount of steam admitted  $\varphi = 10\%$  and a constant length of compression of 100% (una-flow steam engine). The ordinates of the individual curves indicate that for a given clearance volume the critical back pressure  $p_2$  is proportional to the initial pressure  $p_1$ , which is also evident from the previous equation,

$$\left(\frac{p_2}{p_1}\right)^{\frac{1-n}{n}} = \frac{1}{x}, \quad \text{or} \quad p_2 = p_1 \left(\frac{1}{x}\right)^{\frac{n}{1-n}} = p_1 x^{-\frac{1,33}{1-1,33}} = p_1 x^4. \quad (\text{XVIII})$$

Therefore, *for the same clearance volume, the same output and the same length of compression, the critical back pressure is proportional to the initial pressure.*

*For the same initial pressure, output and length of compression, the critical back pressure varies with the clearance volume at a steadily increasing rate, at first slowly, then more rapidly, until the rate of increase attains a linear maximum.*

The critical back pressure is zero for zero clearance volume, and is small for very small clearances. This is self-evident and also proved by the curves, but is frequently left out of consideration in the design of steam engines. The clearance volume is therefore the cause of all evil. If the clearance volume is made zero the critical back pressure as well as the volume loss are zero, and the reciprocating engine in this respect is put on the same level as the steam turbine. Noteworthy is the slow initial increase of the critical back pressure, which again calls attention to the necessity of small clearance volumes.

Fig. 33 gives the relation of the critical back pressure to the amount of steam admitted, for different clearance volumes, for a constant initial pressure of 13 at. abs. and a constant length of compression of 100%. The critical back pressure grows with decreasing amount of steam admitted. In this case also the necessity for small clearance volumes is evident, especially for early cut-offs, as for instance in condensing una-flow engines.

Therefore: for a constant clearance volume, for the same initial pressure and length of compression, the critical back pressure increases with decreasing output.

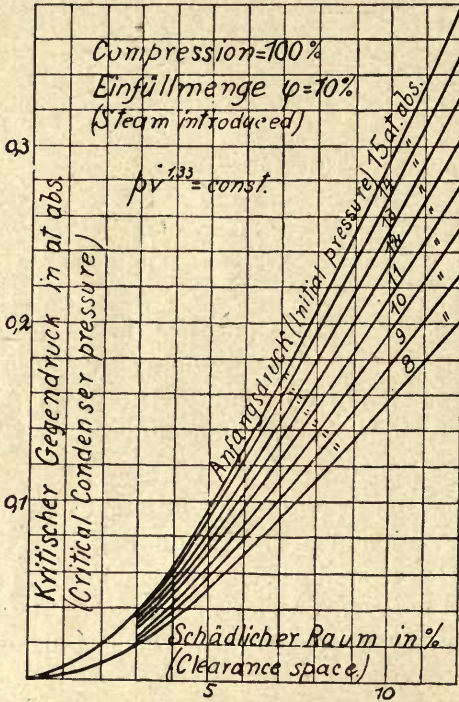


Fig. 32.

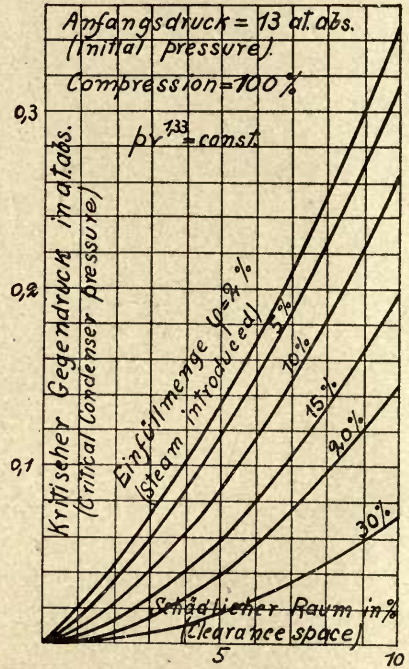


Fig. 33.

Critical back pressure plotted against length of compression is shown in Fig. 34. Each curve refers to a different amount of steam admitted, the initial pressure being 13 at. abs. and the clearance volume 2% in all cases. The curves show first a rapid increase of the critical back pressure which attains a maximum at about 30 or 40% length of compression, followed by a steady decrease. The effect of the compression is the less, the higher the MEP or the greater the amount of steam admitted. The curves confirm the lengths of compression ordinarily used in counterflow engines for normal cut-offs of 30 to 40% and more, and the compression of una-flow engines (100%) for the usual admissions of 15 to 10% and less. On the other hand Figs. 32 and 33 seem to lend support to the long admissions and subdivided pressure ranges of counterflow engines. In the case of multi-stage engines the low pressure cylinder and receiver pressure are the determining factors for the critical back pressure. The compression has the least influence, especially for late cut-offs. It should be noted here that the scale of ordinates in Fig. 34 is twice that of Figs. 32, 33 and 35.

The interrelation of critical back pressure, length of compression and clearance volume is given in Fig. 35, the initial pressure being 13 at. abs. and the amount of steam admitted 10%. The curves show the immense influence of the clearance upon the critical back pressure, which latter seems to follow a geometrical progression with increasing clearance. The critical back pressure increases rapidly up to about 40% length of compression, the rate of increase being progressively larger for larger clearances, after which it shows a steady decrease with increasing length of compression.

In the order of the influence exerted, the clearance volume ranks first, then initial pressure, then admission and finally length of compression. The need for small clearance volume

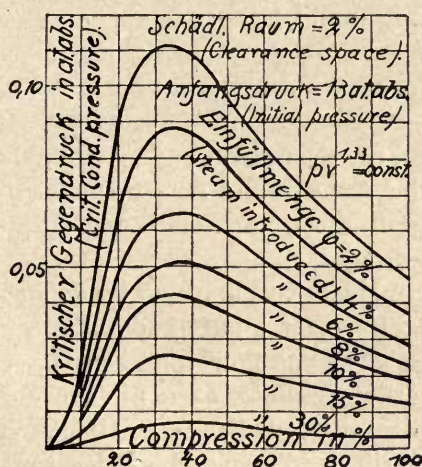


Fig. 34.

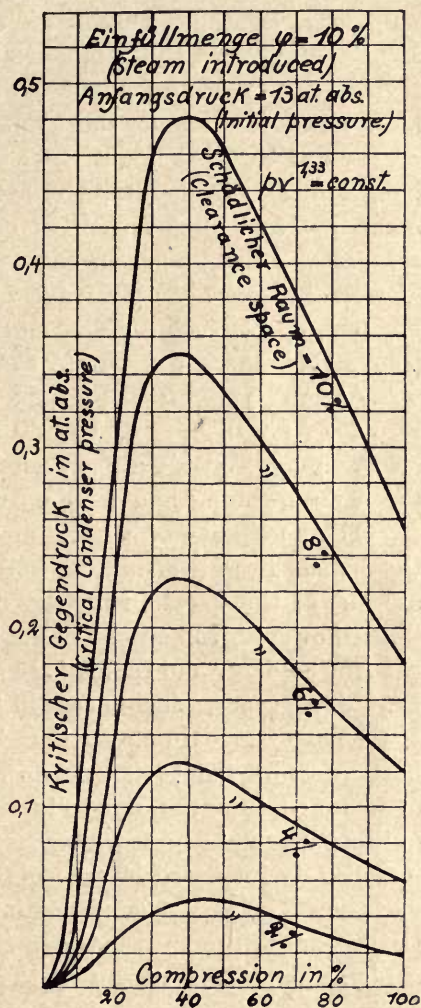


Fig. 35.

is imperative. This is fulfilled in the best possible manner by the una-flow engine, especially if fitted with high lift single-beat poppet valves which allow a clearance of 1% to be realized. The length of compression (90%) combined with the short cut-offs as used in una-flow engines is also favorable, since Fig. 32 gives a critical back pressure of only 0.004 at. abs., for  $p_1 = 10$  at. abs.,  $\varphi = 10\%$ ,  $V_k = 100\%$ , and  $S_0 = 1\%$ ; a back pressure which is beyond even the most modern condensing equipment. At the same time the above combination also gives a very small volume loss. The question is not to produce an engine which has the smallest critical back pressure, but one which combines the latter with a small volume loss. It is possible to have a large volume loss and yet a critical back pressure equal to zero, for instance in the case of large clearance volume and compression equal to zero.

On account of the adverse influence of high initial pressure combined with short admission, the single stage una-flow engine has to rely upon small clearance volumes which, however, can be realized without difficulty. Compound or triple expansion counterflow engines can be run with more liberal clearance volumes by reason of the long admission and the low initial or receiver pressure and still have a critical back pressure beyond that attainable with the best condensers. The case is very different for single stage counterflow engines which usually have very large clearance volumes. For instance, according to Fig. 35, a single stage engine with  $S_0 = 10\%$ ,  $p_1 = 13$  at. abs.,  $\varphi = 10\%$ , and  $V_k = 40\%$ , has a critical back pressure of about 0.5 at. abs. All the bad influences are cumulative; large clearance volume, short admission and the most unfavorable length of compression of 40%. It might not be impossible to find an engine combining all these points, in actual operation. For 20% clearance, 15 at. abs. initial pressure, 10% admission and 40% length of compression, the critical back pressure becomes 1 at. abs. To run such an engine condensing would be utterly wasteful. *The use of several stages not only reduces the volume loss, but also lowers the critical back pressure, and to such a degree that other defects, such as large clearance volumes, lose their significance, to a certain extent.*

As can be seen from Figs. 32, 33, 34 and 35, the critical back pressure becomes zero for  $S_0 = 0$ ,  $p_1 = 0$ ,  $V_k = 0$  and attains a maximum for zero admission. In all the above considerations, admission, mean effective pressure and output have the same meaning and may be used indiscriminately.

The possibility of causing an increase in steam consumption by going beyond the critical back pressure, as well as the useless generation of too high a vacuum are out of the question in case of well designed una-flow engines. These conditions, however, sometimes occur in counterflow engines, even to such an extent that the engineer and fireman are able to notice the bad effect of too high a vacuum. Prof. Josse reports such a case in the *Zeitschrift des Vereines deutscher Ingenieure*, 1909, page 324. He states that "the economy of the engine improved until the back pressure fell to 0.2 at. abs. From this point onwards a further reduction in steam consumption due to increased vacuum was not noticeable". Such a result in this particular engine was caused not only by the critical pressure being exceeded, but also by increased losses of initial condensation and leakage due to the higher vacuum. The initial condensation was considerable in this case. Further more, the pressure difference between the engine cylinder and condenser increases with a high vacuum by reason of the usual deficiency in exhaust area. In una-flow engines the exhaust port areas can always be made sufficiently large; leakage and initial condensation are reduced because the engine has no exhaust valves and may be fitted with single-beat inlet valves, and furthermore has the benefit of the una-flow action. In well designed and well built una-flow engines the results of the above calculations, which implicitly contain the rule of equal heat changes, do not, therefore, require any appreciable corrections.

For given initial and mean effective pressures, the lowest steam consumption is obtained when the clearance volume is zero and the back pressure is zero; the length of compression has then no influence. The critical back pressure, i. e. the most economical back pressure, and the length of compression become of impor-

tance as soon as the clearance volume has a definite value. According to Fig. 31 the length of compression can then be increased to 100% and the back pressure reduced until the changes of total heat during compression and expansion become equal, thus offering the best basis for low steam consumption. In other words: *for a given initial pressure, given mean effective pressure and given clearance volume, the minimum steam consumption will be obtained when the length of compression is 100% and the back pressure is such that the change of total heat during expansion is equal to the change of total heat during compression. (Una-flow steam engine.)*

This rule may also be arrived at if the second wording of the fundamental law given on page 31, dealing with back pressure, is applied to una-flow engines. The minimum steam consumption requires the shortest possible cut-off and the longest possible compression of 100%, these being related to each other by the rule of equal heat changes.

An examination of the common types of steam engines will reveal the fact that *incorrectly designed engines are the rule and correctly designed engines the exception*. There is hardly a steam engine designer who is not guilty of some violation in this respect. To begin with, the average designer is not aware of the harmfulness of the clearance volume, which explains the carelessness with which unnecessarily large clearances are used. The latter are rendered necessary for short cut-offs, for instance in locomotives, marine engines, or non-condensing engines with shaft governor controlling both inlet and exhaust. In marine engines this is the case with the high and intermediate cylinders, while the low pressure cylinders usually have unnecessarily large clearances. The lengths of compression are frequently incorrect. These "necessarily" and "unnecessarily" large clearances can be avoided. A knowledge of the above rules is indispensable, as well as recognition of the fact that changes in load as well as change of rotation may be accomplished merely by the steam admission organs without change in the exhaust timing. The proper choice of steam distributing organs as well as their arrangement and mechanism are also important factors. For instance, a single-stage condensing una-flow marine engine with single-beat valves arranged in the cylinder heads fulfills all of the above conditions. (See Fig. 31, Chapter V.) This engine has the great advantage of a small clearance volume of less than 1%; the exhaust timing is independent of the inlet gear and the constant length of compression is correct and permissible. The same reasoning holds true for the stationary una-flow engine having single-beat valves. (See Fig. 6, Chapter VI.) Both types of engine therefore have very small volume losses despite the large pressure ranges. In the same way a considerable reduction of clearance volume in non-condensing una-flow engines can be accomplished by shortening the compression (large exhaust lead). This is shown in Fig. 32, Chapter III, including also the effect of an exhaust ejector, which produces a proper change of compression with the cut-off, thereby further reducing the volume losses.

### Summary.

1. The volume loss is determined by the clearance volume, initial pressure, back pressure, mean effective pressure and length of compression. It increases with increasing initial pressure and clearance volume, decreases with increasing

back pressure and mean effective pressure, and becomes a minimum for a certain length of compression.

2. Correct compression tends to reduce the volume loss; compression may be kept constant for small clearance volumes, but should be varied inversely with the cut-off in case of large clearances (Single cylinder engines).

3. Change of compression in case of high vacuum has no material effect upon the steam consumption.

4. The clearance volume loss is zero if expansion reaches the back pressure and compression rises to the initial pressure.

5. The theoretical steam consumption, for the same initial pressure, back pressure, mean effective pressure and best compression in each case, increases nearly linearly with the clearance volume. Apart from very small values of the clearance and mean effective pressure, this linear dependence is almost exact for condensing operation, and approximate for atmospheric exhaust.

6. For given initial pressure, back pressure, mean effective pressure and clearance volume, the length of compression must be such that the change of total heat during expansion is equal to the change of total heat during compression.

7. For given initial pressure, mean effective pressure, clearance volume and length of compression, the back pressure must be such that the change of total heat during expansion is equal to the change of total heat during compression.

8. For given back pressure, mean effective pressure, clearance volume and length of compression, the initial pressure must be such that the change of total heat during expansion is equal to the change of total heat during compression.

9. For given initial pressure, back pressure, mean effective pressure and length of compression, the clearance volume must be such that the change of pressure during expansion is equal to the change of pressure during compression.

10. For the same initial pressure, back pressure, the same terminal compression pressure and terminal expansion pressure, and for equality of total heat changes, the lengths of the best compressions have the same ratio as the clearance volumes. (Different mean effective pressures.)

11. With proper proportioning of the length of compression, the clearance volume has to be kept as small as possible; this applies especially to single cylinder condensing engines and the low pressure cylinders of compound and triple expansion engines.

12. Subdivision into stages results in reduction of volume losses, the high pressure cylinder having the smallest and the low pressure cylinder the largest volume loss. Intermediate cylinders have a loss between both according to their relative size.

13. For given initial pressure, mean effective pressure and clearance volume, the lowest steam consumption is obtained if the length of compression is made 100% and the back pressure chosen so as to make the change of total heat during expansion equal to the change of total heat during compression (una-flow engine).

14. The critical back pressure is determined by the initial pressure, the clearance volume, the mean effective pressure, and the length of compression. It increases in proportion to the initial pressure and faster than proportionally to

the clearance volume; it first increases with increasing length of compression, then decreases with increasing length of compression and increasing mean effective pressure. It is zero for initial pressure = zero, clearance volume = zero, length of compression = zero, and attains a maximum for mean effective pressure = zero. The clearance volume has by far the greatest influence, the pressure range has less, and the length of compression and mean effective pressure have the least.

15. In compound engines the low pressure cylinder determines the critical back pressure. Under the same conditions compounding reduces the critical back pressure corresponding to the lower initial pressure of the low pressure cylinder.

16. It is not so important merely to achieve low critical back pressure alone as it is to obtain simultaneously small volume losses and low critical back pressure. The volume loss may be very large and the critical back pressure may still be zero. Of all single cylinder condensing engines, the single-beat poppet valve un-a-flow condensing engine has at the same time the smallest volume loss and a critical back pressure which is far below anything that can be reached even with the most modern condensing equipment, mainly on account of its small clearance of less than 1% and its favorable length of compression.

## 2b. Additional Clearance Space.

Practically all condensing una-flow engines must be able to run non-condensing. In case of breakdown of the condenser, lack of cooling water, or during the winter months when the exhaust steam is used for heating purposes, the engine must be capable of operation with either atmospheric or higher back pressures. The

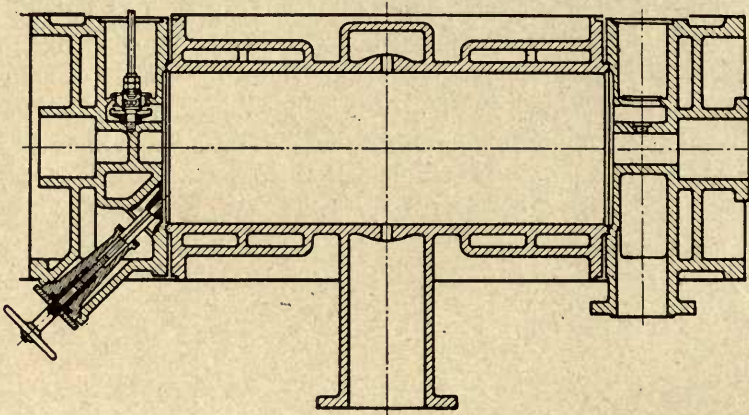


Fig. 1.

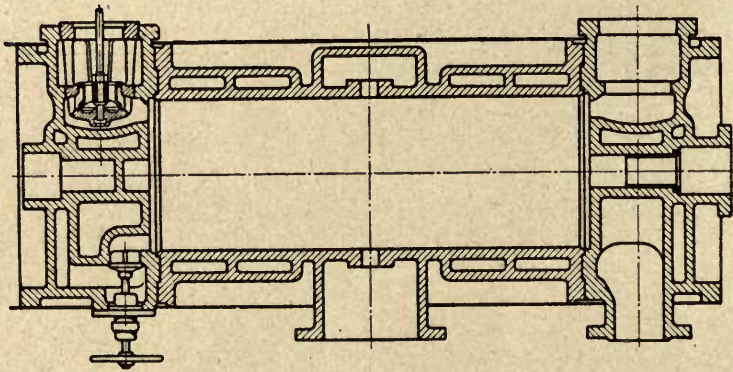


Fig. 2.

simplest way of accomplishing this purpose is the provision of an additional clearance space. (See Figs. 1 and 2.) The amount of additional clearance depends upon the initial and back pressure. If the latter is for instance 1 at. abs., the initial pressure 13 at. abs., and the clearance for condensing operation 1.5%, then the additional clearance should be 14.75%, according to the tables to be given later. At the same time this increased clearance will cause a lengthening



of the cut-off from 8 to 12% for the same output with non-condensing operation (Fig. 3). The drop in pressure at the end of expansion amounts to 0.8 at. for condensing and 1.0 at. for non-condensing operation. It is found that for other initial pressures, with approximately the same drops of pressure (0.8 or 1 at. abs.) at the end of expansion, the mean effective pressures produced are about equal. In the previous chapter it was demonstrated that the mean specific volume loss for saturated steam of 13 at. abs. and non-condensing operation was 0.0918 kg/HP-hour and per 1% clearance, and 0.072 kg/HP-hour, and per 1% clearance for superheated steam of 300° C, the other data being the same. For 14.75% clearance the total losses amount to 1.35 and 1.06 kg respectively in the two cases. The general adoption of the additional clearance space despite this considerable increase in steam consumption is due firstly to its simplicity, and secondly to qualities which tend partly to counteract this heavy loss. The effect on the overall economy is negligible if an engine operates with additional clearance only for several days or hours during the course of a year. Fig. 3 also indicates that although the drop in pressure at the end of expansion

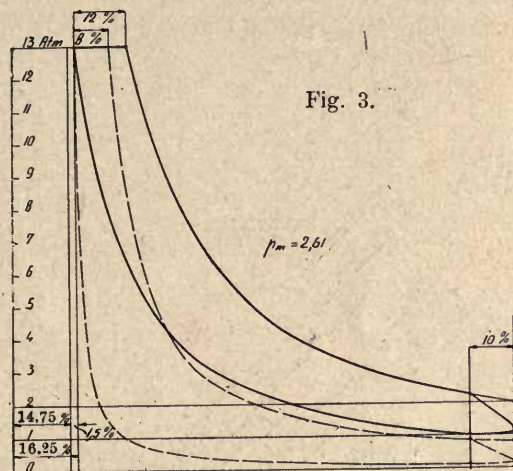


Fig. 3.

is higher when using the additional clearance space, the loss due to incomplete expansion is less; and the condensing cylinder being rather large for non-condensing operation becomes more or less adapted to this condition. The additional clearance also preserves the una-flow principle, including the series arrangement of live steam space, inlet valve, piston and exhaust, which is such a valuable feature of the una-flow engine. Although it is possible to use auxiliary exhaust valves instead of additional clearance, and these valves being relieved of pressure at the time of opening can be of single beat or annular construction, no joint at all being preferable to even a tight joint or seat.

Care must be taken that the clearance valves which control the additional clearance pocket do not materially add to the cylinder clearance for condensing operation (Figs. 4 and 5). In this respect it is advantageous to provide the clearance valves with projections which fill up the space between valve seat and cylinder surface. The valve area of the clearance valves must be large enough to avoid throttling during expansion and compression. It is also advisable to arrange the additional clearance so that it will act as a kind of heat insulator when the engine is running condensing, which is especially of value for the crank end of the cylinder.

The clearance valve may also be designed in the form of a spring loaded safety valve, but then the above mentioned projections cannot be used. The safety valve action of the clearance valve is unnecessary when the main steam valve is not, or only partly balanced so that it can act as a safety valve. The "safety"

inlet valve is preferable to the "safety" clearance valve since its weight and spring load are less. The inlet valve is designed for high speed and held closed by steam pressure, its spring being only strong enough to overcome inertia. The clearance valve on the other hand is heavy and its spring has to overcome the total steam pressure. In case of sudden failure of the vacuum this heavy spring load combined with the great weight of the valve cause an objectionable hammering, which can only be stopped by screwing the valves back.

In Fig. 6 is reproduced a diagram such as is obtained from a una-flow engine running non-condensing and fitted with auxiliary exhaust valves, the clearance being the same ( $1\frac{1}{2}\%$ ) as for condensing operation. It is evident that the ratio

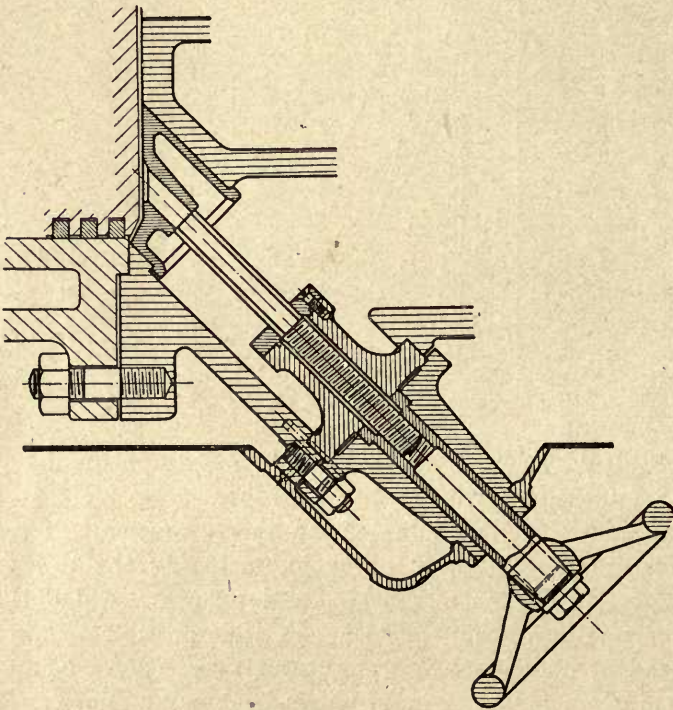


Fig. 4.

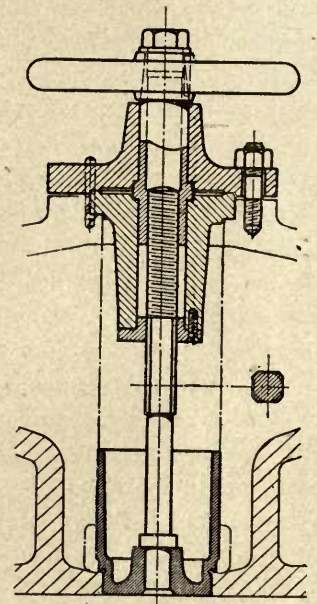


Fig. 5.

of expansion is too high. A construction of this kind is shown in Fig. 7, having the auxiliary exhaust valves arranged in the cylinder heads. The increase in clearance volume due to these valves was not taken into consideration in the diagram of Fig. 6. The diagram indicates that, assuming the same mean effective pressure, the expansion line reaches the back pressure while the piston uncovers the exhaust ports. The loss due to incomplete expansion is zero. The shape of the diagram indicates the counter-flow action and proves that the cylinder is too large for non-condensing operation, especially for smaller loads, when the toe will change into a loop. This produces a backflow of exhaust steam into the cylinder and a corresponding increase in condensation losses. For loads higher than normal the exhaust action will be partly una-flow and partly counterflow. The loop at the end of expansion cannot occur in engines fitted with additional clearance spaces.

The worst feature of auxiliary exhaust valves, however, is their detrimental effect upon the condensing operation of the engine. They increase the clearance space and the harmful surfaces as well as the possibility of leakage, and sacrifice the very valuable series arrangement of live steam space, inlet valve, piston and exhaust. For 1% increase in clearance volume, an additional steam consumption of 0.12 kg/IHP-hour may be expected, superheated steam being assumed. This figure does not include the effect of leakage and the surface losses caused by the valves and their pockets, nor additional losses due to the operation of these valves while the engine is running condensing. It is advisable to keep these valves in operation even while running condensing, since they are liable to stick after remaining out of use for some time. If the auxiliary exhaust valves shorten the length of compression also for condensing operation, a larger volume loss results, because

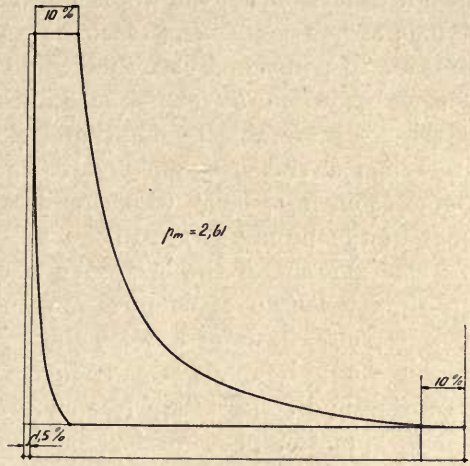


Fig. 6.

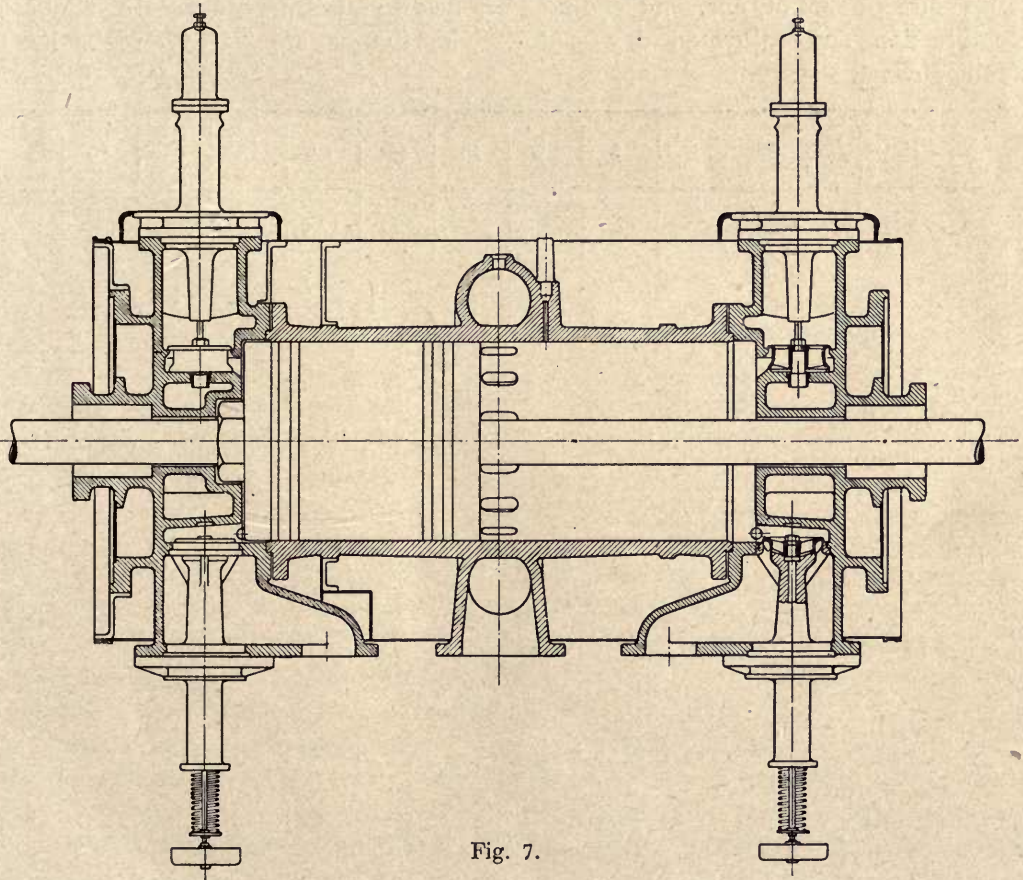


Fig. 7.

an increase in clearance necessitates a corresponding lengthening of the compression. The bad effect upon condensing operation appears all the more objectionable since it occurs during the whole working period; while on the other hand, for short periods of non-condensing service even a considerable increase in steam consumption due to additional clearance could be tolerated. For long periods of non-condensing operation, as for instance during the winter, single-beat auxiliary exhaust valves are preferable to additional clearance.

When auxiliary exhaust valves are used, they are usually placed below the engine room floor level, which renders their attendance difficult and the arrangement of the piping awkward.

The amount of the necessary clearance is determined by the following rule: for a given length of compression, mean effective pressure, initial pressure and back pressure, in order to keep the volume loss as small as possible, the clearance volume should be made large enough to produce equal variation of pressure during expansion and compression (see chapter on volume loss). On an average, the terminal expansion pressure for non-condensing operation may be taken as 1 at. gage, and this implies a terminal compression pressure of 1 at. below initial pressure.

The following table gives the total amount of clearance volume required, when operating non-condensing, for 90% length of compression, starting with a pressure of 1.03 at. abs. and ending 1 at. below initial pressure, with adiabatic compression and saturated dry steam. The figures are based on the latest Mollier chart.

Initial Pressure at. abs.	8	9	10	11	12	13	14	15	16
Total Clearance %	27.9	23.8	21.3	19.2	17.6	16.25	15.15	14.2	13.4

### 3a. Losses due to Throttling.

Throttling is a change of state in which the total heat remains constant, the effect of which is to diminish the amount of heat and the pressure difference available for utilization between boiler and condenser. Losses due to throttling may occur in the superheater, steam main from superheater to the engine, stop valves, inlet valves, piston-controlled exhaust ports or exhaust valves, and in the exhaust pipe between engine and condenser (Fig. 1).

The losses due to throttling occurring in the superheater, steam pipe, stop valves, and inlet valves may be partly regained in connection with the subsequent expansion, although the greater part is lost. The percentage of this regain depends

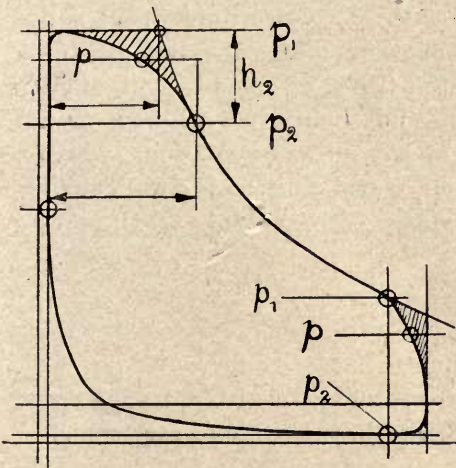


Fig. 1.

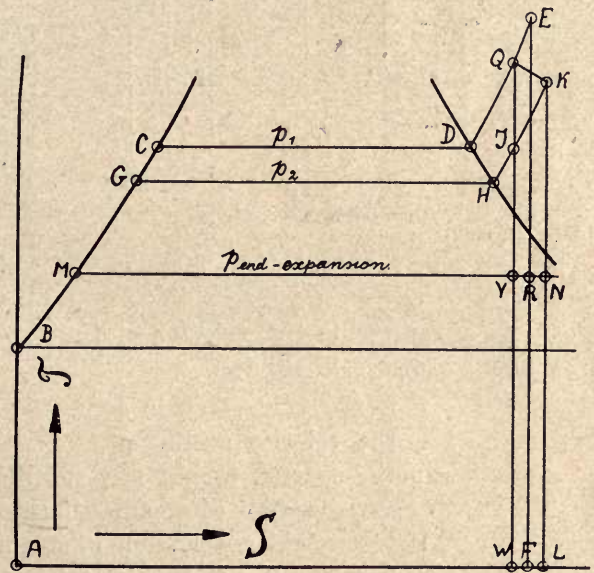


Fig. 2.

upon the extent of the expansion. The temperature-entropy diagram in Fig. 2 shows the conversion of a certain quantity of heat at high temperature and small entropy into an equal quantity at lower temperature and larger entropy. The change is represented by the area  $GCDQKHG$  and is equal in area to the strip  $QKLWQ$  which results from increasing the entropy. The part  $KNVJK$ , falling within the area of expansion will be regained, while the part  $NLWVN$  below the line of terminal expansion pressure is definitely lost. Throttling losses occurring in the exhaust valves or exhaust pipe are irretrievable, for which reason they must be restricted to the smallest possible amount. They are especially harmful because

their effect extends through the whole compression stroke. (See chapter on the relation of the una-flow engine and the condenser.)

The heat losses and throttling losses in the steam pipe cannot be separated and are usually combined in one figure; a loss of 0.5 to 1.0% is considered an average and corresponds to a steam velocity of about 40 to 50 m/sec, calculated on the total amount of steam flowing through.

The throttling losses occurring between the stages of multistage engines are eliminated in the una-flow engine.

In order to estimate the throttling losses in the inlet and exhaust valves it is necessary to know the relation between effect (losses) and cause (valve area), to which the following calculations refer.

**Determination of inlet valve areas.**

In Fig. 3,  $p_1$  and  $v_1$  represent the pressure and volume of the steam at the dead center position of the piston; piston travel  $x_1 = 0$  and corresponding crank angle  $\delta_1 = 0$ .  $p_2, v_2$  are the pressure and volume at the point of valve closing, for a piston travel =  $x_2$  and crank angle =  $\delta_2$ .  $p$  and  $v$  are the pressure and volume at any intermediate point where the piston travel =  $x$  and crank angle

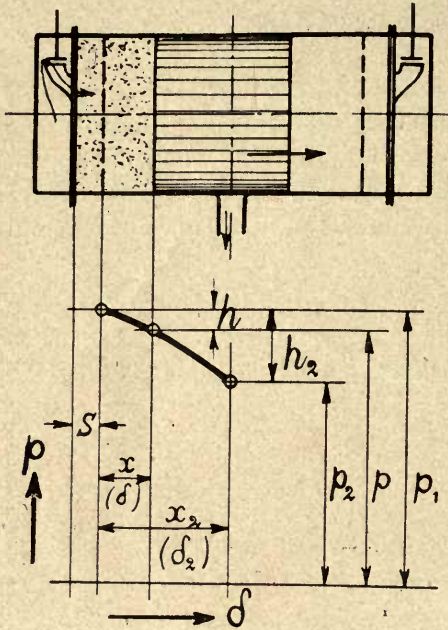


Fig. 3.

=  $\delta$ ;  $w$  represents the velocity of the entering steam corresponding to the prevailing pressure difference.

- $F$  is the valve area in sqm,
- $\varphi$  the velocity coefficient,
- $\gamma, v$  the specific weight and specific volume,
- $t$  the duration of steam admission corresponding to piston travel  $x_2$ ,
- $Q, V$  the weight and volume of steam contained in the cylinder corresponding to piston travel  $x$

$$dQ = \varphi \cdot w \cdot F \cdot \gamma \cdot dt \dots \dots \dots (1)$$

$$Q = \frac{V}{v}$$

The change of state during throttling is represented approximately by the equation

$$p_1 v_1 = p v = p_2 v_2 = c$$

or

$$v = \frac{c}{p}$$

$$Q = \frac{V}{c} \cdot p$$

$$dQ = \frac{1}{c} d(V \cdot p) = \frac{1}{c} V \cdot dp + \frac{1}{c} p \cdot dV$$

$$\varphi \cdot \omega \cdot F \cdot \gamma \cdot dt = \frac{V}{v} \cdot \frac{dp}{p} + \frac{dV}{v}$$

$$\frac{dp}{p} = -\frac{dV}{V} + \varphi \cdot \omega \cdot F \cdot \frac{1}{V} \cdot dt$$

$$t = \frac{60 \cdot \delta_2}{n \cdot 360}; \quad dt = \frac{d\delta}{6n}$$

$$V = \frac{\pi}{4} D^2 H (x + s)$$

$D$  and  $H$  are the cylinder diameter and stroke respectively in meters;  $s$  = clearance volume in % of stroke. Engine constant =  $D^2 \cdot H \cdot n = A$

$$\frac{dp}{p} = -\frac{\frac{\pi}{4} D^2 \cdot H d(x+s)}{\frac{\pi}{4} D^2 \cdot H (x+s)} + \frac{\varphi \cdot \omega \cdot F \cdot dt}{\frac{\pi}{4} D^2 \cdot H (x+s)}$$

$$= -\frac{dx}{x+s} + \frac{0,2125 \cdot \varphi \cdot \omega \cdot F \cdot d\delta}{A (x+s)} \dots \dots \dots (2)$$

For a small drop in pressure it may be assumed with sufficient accuracy that

$$\omega = \sqrt{2g(p_1 - p) \cdot v_1}$$

In order to facilitate the calculations, the admission line or rather the curve representing the change in pressure plotted against crank angle or time will be replaced by a parabola. It will be shown later that this assumption is admissible if the object of the calculation is not the shape of the admission line but the final drop of pressure at the end of admission. This final pressure drop, however, is to form the basis of the determination of the inlet valve areas. Therefore we may write

$$p_1 - p = a \delta^2 \text{ and } p_1 - p_2 = a \delta_2^2$$

or

$$p_1 - p = (p_1 - p_2) \frac{\delta^2}{\delta_2^2}$$

and therefore

$$\omega = \sqrt{2g \cdot v_1 (p_1 - p_2) \frac{\delta}{\delta_2}} \dots \dots \dots (3)$$

combining equations (3) and (2)

$$\frac{dp}{p} + \frac{dx}{x+s} = \frac{0,2125 \cdot \varphi \sqrt{2g \cdot v_1 (p_1 - p_2)} \cdot F \cdot \delta \cdot d\delta}{A (x+s) \delta_2}$$

$$\left. \begin{aligned} \int_{p_1}^{p_2} \frac{dp}{p} + \int_s^{x_2+s} \frac{dx}{x+s} &= \\ \log_e \frac{p_2}{p_1} + \log_e \frac{x_2+2s}{2s} &= \left\{ \frac{0,2125 \cdot \varphi \sqrt{2g \cdot v_1 (p_1 - p_2)}}{A \cdot \delta_2} \cdot \int_0^{\delta_2} \frac{F \cdot \delta \cdot d\delta}{x+s} \right. \\ 2,3 \cdot \log_{10} \frac{p_2 (x_2 + 2s)}{p_1 \cdot 2s} &= \end{aligned} \right\}$$

$$\int_0^{\delta_2} \frac{F \cdot \delta \cdot d\delta}{x+s} = \frac{A \delta_2 \cdot 2.444}{\sqrt{v_1(p_1 - p_2)} \cdot \varphi} \log_{10} \frac{p_2(x_2 + 2s)}{p_1 \cdot 2s} \quad (4)$$

Assuming the admission, clearance volume, initial pressure, initial temperature, pressure drop, velocity coefficient and the engine constant to be known quantities, then the right hand side of equation 4 reduces to a numerical value. If, for  $A = 1$ , this value is  $C$ , then for any other value of  $A$  the result is  $CA$ , or

$$\int_0^{\delta_2} \frac{F \cdot \delta \cdot d\delta}{x+s} = AC$$

and

$$C = \frac{\delta_2 \cdot 2.444}{\sqrt{v_1(p_1 - p_2)} \cdot \varphi} \log_{10} \frac{p_2(x_2 + 2s)}{p_1 \cdot 2s}$$

If the driving element is an eccentric or a crank, and if the valve seats are flat, then we may write  $h = a \cdot h_{max}$  and correspondingly  $F = a \cdot F_{max}$  (Fig. 4).

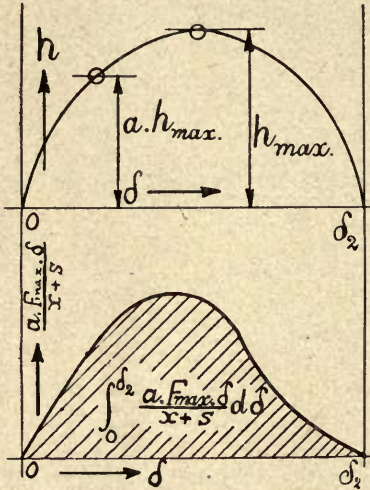


Fig. 4.

Multiplying  $a \cdot F_{max}$  by  $\frac{\delta}{x+s}$  and plotting

this product on a diagram against  $\delta$  as abscissae,

a curve is obtained as shown in Fig. 4, the area of which is

$$J = \int_0^{\delta_2} a \cdot F_{max} \frac{\delta \cdot d\delta}{x+s} = BF_{max}$$

Accordingly  $F_{max} = \frac{A \cdot C}{B}$ , where  $B = \int_0^{\delta_2} \frac{a \cdot \delta \cdot d\delta}{x+s}$ . If  $p_1$ ,  $v_1$ ,  $s$  and  $\varphi$ ,

as well as the pressure drop  $p_1 - p_2$  are known, then  $F_{max}$  can be easily calculated.

### Permissible average values.

For most una-flow condensing engines the following values can be assumed:

- Initial pressure  $p_1 = 13$  at. abs.
- Steam temperature  $t_1 = 300^\circ$  Centigrade.
- Specific volume  $v_1 = 0.2$  cbm/kg.
- Clearance Volume  $s = 3\%$  (double beat-valves).
- Velocity Coefficient  $\varphi = 0.6$  for double-beat valves, piston valves and slide valves.
- Velocity coefficient  $\varphi = 0.8$  to  $0.9$  for single-beat and Corliss valves (the higher figure for machined ports and passages).

Lead of the steam valve = 0.

With the above values and  $\varphi = 0.6$  (double-beat valve),

$$C = \frac{9.13 \delta_2}{\sqrt{130000 - p_2}} \log_{10} \frac{p_2(x_2 + 0.06)}{7800}$$



Values of  $C$ , calculated by means of this formula for various admissions  $x_2$  and various pressure drops at the end of admission are plotted in Fig. 5. For any cut-off and pressure drop, the corresponding value of  $C$  may be read off. Multiplying this by the engine constant  $A$ , the right hand side of equation 4 is disposed of.

The left hand side  $\int_0^{\delta_2} \frac{F \cdot \delta \cdot d \delta}{x + s}$ , may be integrated graphically for each separate case.

The first step is to lay out a curve showing the valve lifts  $h$  plotted against piston travel for each cut-off. The corresponding valve areas are  $F = b \cdot h$  ( $b =$  width of port) for slide valves,  $F = \pi \cdot d \cdot h$  for single-beat valves, and  $F = 2 \cdot \pi \cdot d \cdot h$  for double-beat valves. ( $d =$  smallest valve seat diameter). For each area  $F$  the corresponding values of  $\delta$  and  $x$  and therefore of the expression  $\frac{F \cdot \delta}{x + s}$  are easily obtained.

For example, the piston travel is 30% for a crank angle of  $66,4^\circ$  and since the clearance volume  $s$  is to be 3%  $\frac{\delta}{x + s} = \frac{66,4^\circ}{0.3 + 0.03}$ .

Plotting  $\frac{\delta}{x + s}$  as ordinates against  $\delta$  as abscissae, then a narrow strip of the enclosed area on the base  $d\delta$  represents the expression  $\frac{F \cdot \delta \cdot d \delta}{s + x}$ . If the curve commences at  $\delta = 0$ , then the enclosed area up to any value  $\delta_2$ , measured by means of a planimeter, represents the expression

$$\int_0^{\delta_2} \frac{F \cdot \delta \cdot d \delta}{x + s}$$

The effect of the fraction  $\frac{\delta}{x + s}$  is of interest (Fig. 7). It increases rapidly at first until it attains a maximum for a crank angle of  $\delta = 20^\circ$ , after which it gradually decreases. This curve is obtained by means of the curve Fig. 6, which shows the relation between  $\delta$  and  $x$ .

It will be remembered that a parabola was assumed to represent the admission line on a time basis and this parabola of course presumes a certain valve lift or valve area curve. This  $F$  curve could be developed point by point from the assumed parabola and naturally would differ from an  $F$  curve based on an eccentric circle. The latter curve, however, may be used in this case for

the solution of the expression  $\int_0^{\delta_2} \frac{F \cdot \delta \cdot d \delta}{x + s}$  since, as will be shown later, both

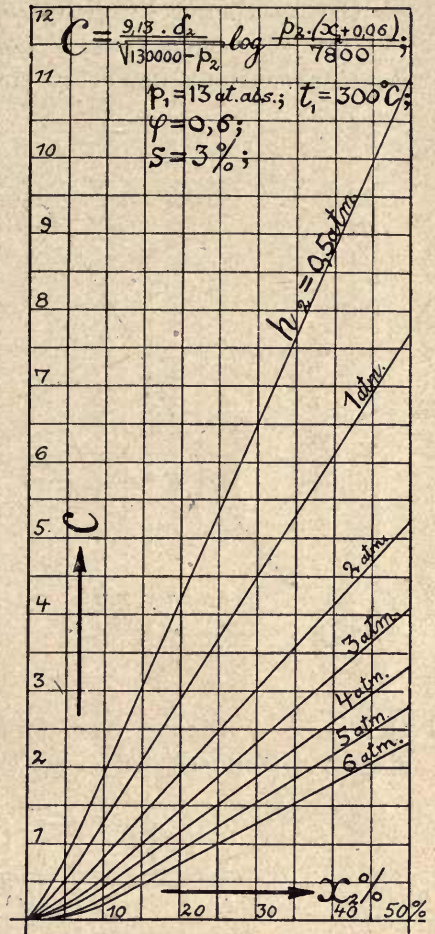


Fig. 5.

kinds of curves result in approximately the same pressure drop at the end of admission.

If a curve representing valve lifts, as produced by an eccentric gear, is plotted against the crank angle, then each valve lift can be expressed in % of the maximum lift (Fig. 8). This percentage is given at 5 points and remains constant for every cut-off and

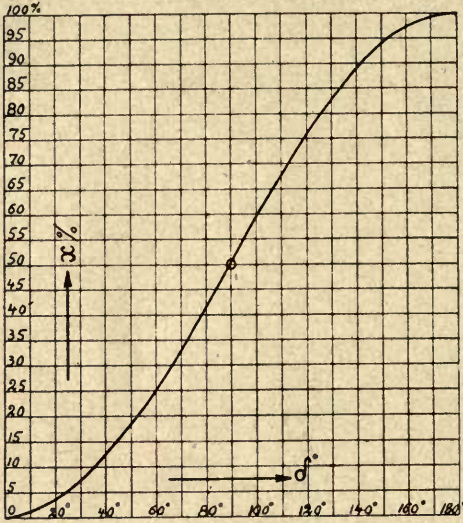


Fig. 6.

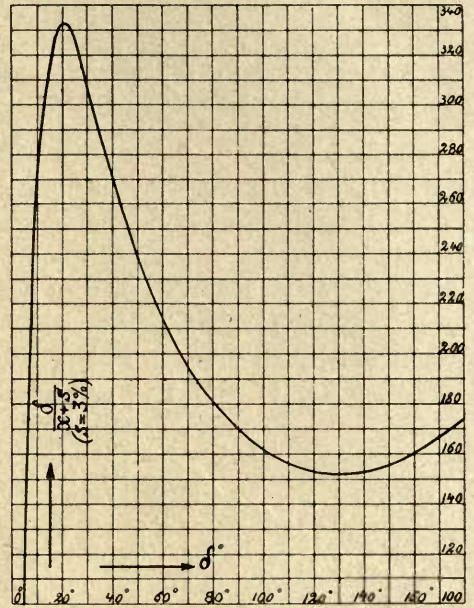


Fig. 7.

the same divisions. Therefore the valve lift curve in Fig. 9 may be considered a standard for every cut-off; or in other words, considering the maxi-

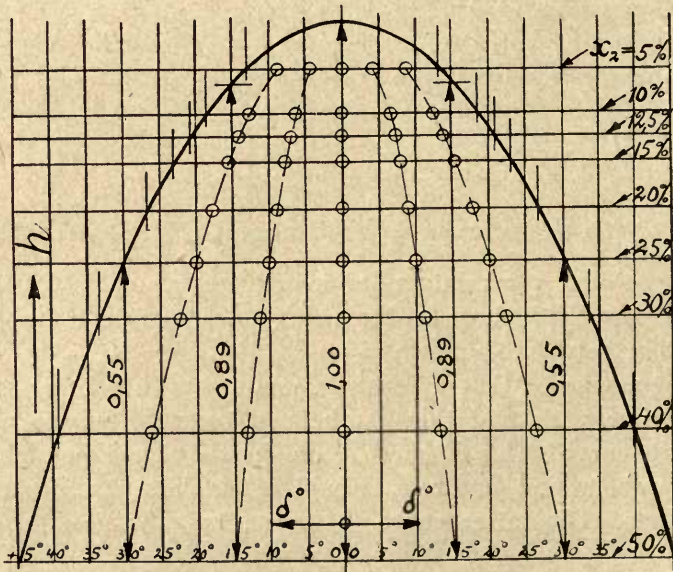


Fig. 8.

imum valve area equal to unity, then the figures written at the division lines indicate the corresponding valve openings. It is assumed that the valve has no lead and does not overrun the port. For example, after  $\frac{1}{8}$  and  $\frac{7}{8}$  of the admission time have elapsed, the valve opening for any cut-off is  $F = 0.43 F_{\max}$ , after  $\frac{1}{4}$  and  $\frac{3}{4}$  time  $F = 0.75 F_{\max}$  and after  $\frac{3}{8}$  and  $\frac{5}{8}$  time  $F = 0.94 F_{\max}$ . Each division also corresponds to a certain value of  $\frac{\delta}{x+s}$ , which of course varies with the cut-off. This value may be combined with the above fractions into a constant  $B$  given by the equation

$$\int_0^{\delta_2} \frac{F \cdot \delta \cdot d\delta}{x+s} = B F_{\max} = C$$

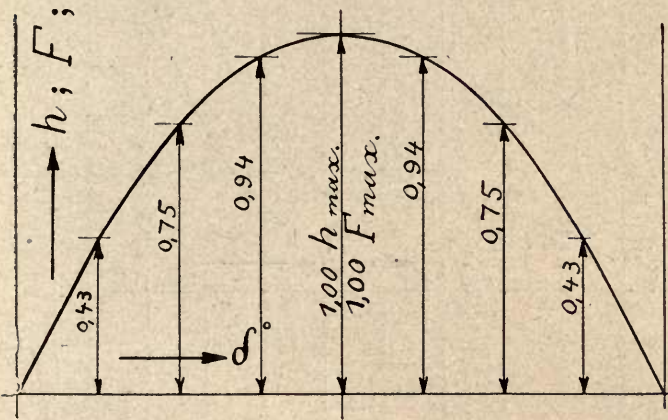


Fig. 9.

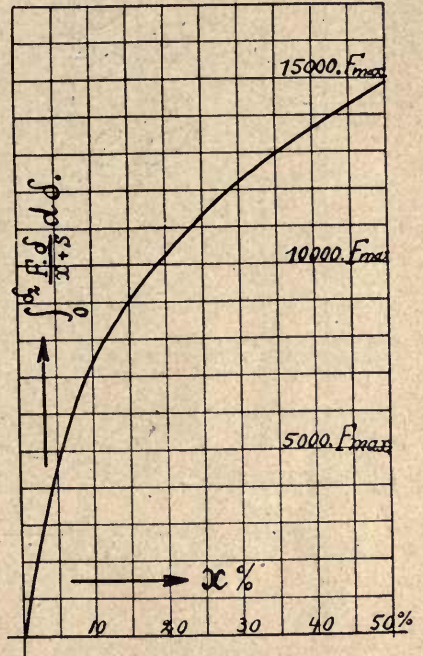


Fig. 10.

or  $F_{\max} = \frac{C}{B}$ . This equation is plotted in Fig. 10. For any cut-off the value of  $F_{\max}$  is obtained by taking the corresponding value of  $B$  from Fig. 10 and dividing it into the value of  $C$ , derived from Fig. 5 for the same cut-off and some particular pressure drop,  $A = 1$ ,  $\varphi = 0.6$ ,  $s = 0.03$ ,  $p_1 = 13$  at. abs.,  $t_1 = 300^\circ \text{C}$ , direct eccentric drive and no cam mechanism being assumed. The values of  $F_{\max}$  obtained in this manner are given in the following table and plotted in Fig. 11.

$h_2 =$	0,5 at	1 at	2 at	3 at	4 at	5 at	6 at
$x_2 = 5\%$	1.84 cm <sup>2</sup>	1.21 cm <sup>2</sup>	0.72 cm <sup>2</sup>	0.44 cm <sup>2</sup>	0.27 cm <sup>2</sup>	0.12 cm <sup>2</sup>	0.02 cm <sup>2</sup>
$x_2 = 10\%$	2.67 "	1.8 "	1.13 "	0.82 "	0.61 "	0.44 "	0.28 "
$x_2 = 20\%$	4.08 "	2.82 "	1.85 "	1.41 "	1.13 "	0.90 "	0.7 "
$x_2 = 30\%$	5.36 "	3.67 "	2.47 "	1.90 "	1.57 "	1.27 "	1.06 "
$x_2 = 40\%$	6.34 "	4.48 "	3.02 "	2.35 "	1.91 "	1.59 "	1.33 "
$x_2 = 50\%$	7.50 "	5.20 "	3.52 "	2.76 "	2.24 "	1.89 "	1.59 "

For any other engine constant  $A = D^2 H \cdot n$ , this value of  $F_{\max}$  must be multiplied by  $A$ ,  $D$  and  $H$  being measured in meters. Then  $F_{\max} = A \cdot \frac{C}{B}$ . If the valve

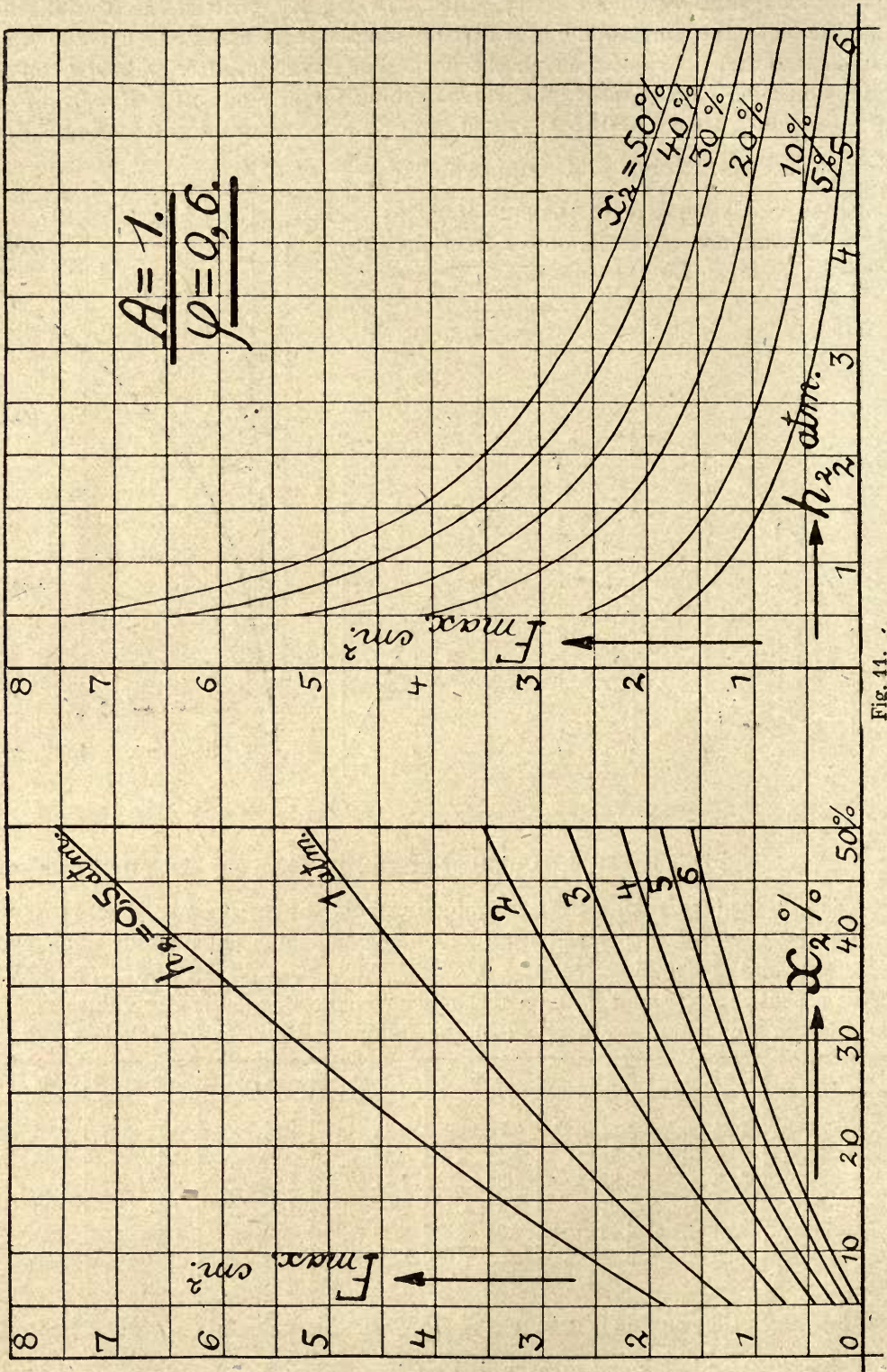


Fig. 11.

is operated by means of a cam then the expression  $\int_0^{\delta_2} \frac{F \cdot \delta \cdot d\delta}{x+s}$  has to be diminished by a certain percentage according to the cam profile. It must also be

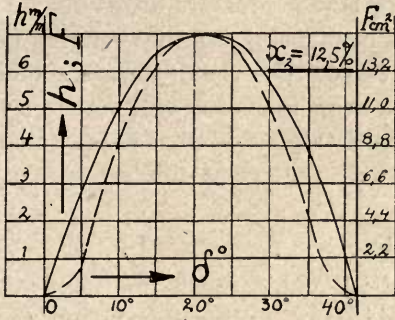


Fig. 12.

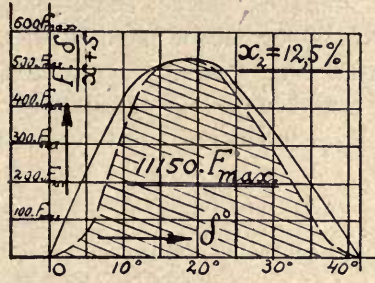


Fig. 13.

considered whether the valve remains stationary during part of the time it is open. (See Figs. 12 and 13.)

In case the steam valve has a certain amount of lead (Fig. 14), the integration of the  $F$  curve must apply only to the area after the dead center, since the

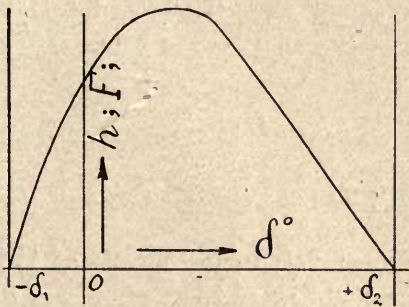


Fig. 14.

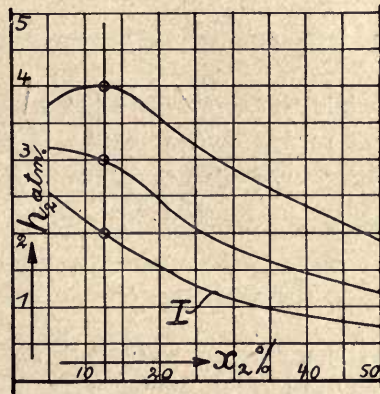


Fig. 15.

purpose of lead is merely to fill up the clearance space, a condition which was assumed from the start.

The values of  $C$  are inversely proportional to  $\varphi$ , and  $\frac{C_1}{C_2} = \frac{\varphi_2}{\varphi_1}$ .

Further,  $F_{max_1} = \frac{A}{B} C_1$ ;  $F_{max_2} = \frac{A}{B} \cdot C_2$  or  $\frac{F_{max_1}}{F_{max_2}} = \frac{C_1}{C_2} = \frac{\varphi_2}{\varphi_1}$ .

Having found  $F_{max}$  for a certain cut-off and pressure drop, the question arises of the pressure drop for different cut-offs. For instance, at 12.5% cut-off and  $h_2 = 2$  at. pressure drop, the value of  $F_{max}$  as taken from the curves in Fig. 11 is 1.325 sqcm. Assuming a direct drive from the eccentric, the values obtained for

the pressure drop for different cut-offs are given in the following table and plotted in Fig. 15.

$x_2 = 5\%$	$10\%$	$12.5\%$	$15\%$	$20\%$	$30\%$	$40\%$	$50\%$
$h_2 = 2.55$	2.2	2.0	1.8	1.55	1.15	0.8	0.7

Fig. 15 also contains two more curves for higher pressure drops during normal admission. These curves show that, if for a condensing una-flow engine the pressure drop is normal for rated cut-off, then a larger cut-off will show a smaller pressure drop. For a small cut-off the pressure drop increases still further, while in case of a higher pressure drop at normal cut-off this gradually tends to be a maximum. For condensing una-flow engines it is sufficient to calculate  $F_{\max}$  for normal cut-off.

### Example.

The necessary valve area of a single-beat valve for a una-flow stationary engine is to be calculated for the following conditions. Cylinder diameter  $D = 0.4$  m, stroke  $H = 0.5$  m,  $r \cdot p \cdot m = 150$ , steam pressure  $p_1 = 13$  at. abs., steam temperature  $t_1 = 300^\circ$  centigrade, assumed pressure drop  $= 2$  at. for 12.5% valve gear cut-off, or  $x_2 = 0.125$  and  $\delta_2 = 41.4^\circ$ ,  $\varphi = 0.8$ ,  $s = 0.01$ .

$$C = \frac{41.4 \cdot 2.44}{\sqrt{0.2(130000 - 110000) \cdot 0.8}} \log_{10} \frac{110000(0.125 + 2 \cdot 0.01)}{130000 \cdot 2 \cdot 0.01} = 1.26.$$

$$\text{Engine constant } A = 0.4^2 \cdot 0.5 \cdot 150 = 12.$$

The large area in Fig. 13 represents the value of  $\int_0^{\delta_2} \frac{F \cdot \delta \cdot d \delta}{x + s}$  for direct eccentric

drive, while the smaller shaded area  $= 2230$  sqmm gives the same integral when a cam or rolling lever is used. If the scale of the abscissae is  $1 \text{ mm} = 0.5^\circ$  and that of the ordinates is  $1 \text{ mm} = 10 F_{\max}$ , then

$$2230 \cdot 0.5 \cdot 10 F_{\max} = 11150 F_{\max} = B \cdot F_{\max}$$

and

$$F_{\max} = \frac{A \cdot C}{B} = \frac{12 \cdot 1.26}{11150} = 0.001356 \text{ sqm}^2 = 13.56 \text{ sqcm}^2.$$

If the maximum valve lift for the assumed valve gear cut-off of 12.5% is equal to  $\frac{1}{10}$  the valve diameter, then  $F_{\max} = \pi \cdot d \cdot 0.1 \cdot d = 13.56 \text{ sqcm}$ ,  $d = 6.6 \text{ cm}$ , and  $h_{\max} = 0.66 \text{ cm}$ . The common empirical formula, based on mean piston velocity would give a steam velocity  $\omega_m = \frac{O \cdot c_m}{F_{\max}} = 92 \text{ m/sec}$ . These calculated values of  $F_{\max}$  and  $h_{\max}$  can be realized without difficulty if the single-beat valve is operated by a lay shaft gear running at twice the engine speed (See final chapter).

### Permissibility of the use of the parabola.

It is still to be proved that the actual diagram admission line plotted against crank angle or time may rightly be replaced by a parabola. For this purpose a diagram is laid out with the crank angles  $\delta$  as abscissae and the valve openings as ordinates. This results in a curve such as that shown in Fig. 16. The total crank angle is now divided into a large number of parts or intervals and for each

part the mean valve area is determined ( $F_1, F_2, F_3$  etc.). It is assumed that  $p \cdot v = \text{const}$ . In the above example it was assumed that  $p_1 = 130000$  kg/sqm,  $t_1 = 300^\circ$ ,  $v_1 = 0.2$  cbm/kg and  $p_1 \cdot v_1 = 26000$ .

Volume of clearance space  $V_1 = s$ ; weight of steam  $Q_1 = \frac{V_1}{v_1}$ ; stroke volume  $= V_H$ ;  $\omega_m = \frac{0 + \omega_2}{2} = \frac{\omega_2}{2}$ ;  $\varphi = 0.8$ ;  $dt = \frac{60 \cdot \delta_2}{n \cdot 360 \cdot i}$  for  $i$  intervals. The piston is first considered to be moved forward a distance corresponding to the first interval without admission of steam, so that  $p_2 = p_1 \cdot \frac{V_1}{V_2}$ ;  $v_2 = \frac{26000}{p_2}$ ;  $\gamma_2 = \frac{1}{v_2}$  and  $\gamma_m = \frac{\gamma_1 + \gamma_2}{2}$ .

These values represent the state of the steam at the end of the first interval, produced by expansion only, without the admission of live steam.  $\omega_m$  and  $\gamma_m$  being also known, it is now possible to calculate the additional weight of steam

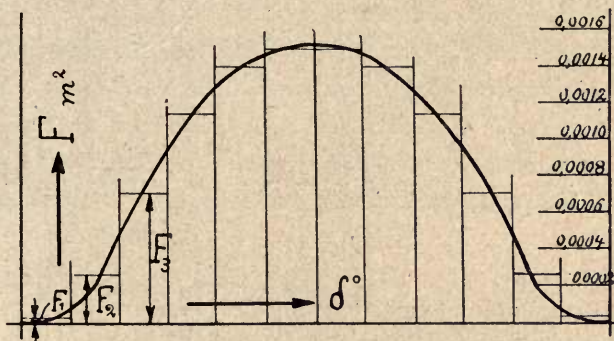


Fig. 16.

admitted, which is  $dQ = \varphi \cdot \omega_m \cdot F_1 \cdot \gamma_m \cdot dt$ . Then at the end of the first interval the cylinder contains the amount  $Q_2 = Q_1 + dQ$  with a corresponding volume of  $V_2 = V_H (s + dx_1)$  in which  $dx_1$  represents the distance the piston has traveled during the time  $dt$ . This gives the actual specific volume of the steam at the end of the first interval  $v'_2 = \frac{V_2}{Q_2}$  and the pressure  $p_2' = \frac{26000}{v'_2}$ .

For the second interval, the piston is again considered moved forward a distance corresponding to the second interval, without steam admission. Starting with the state of the steam at the end of the first interval,  $v_3$  and  $p_3$  are calculated, and the same procedure is repeated as before. In this manner the curves shown in Fig. 17 were obtained, wherein the parabolas are the dotted lines. They are plotted for 25% and 40% valve gear cut-off, both for the true admission line and the substitute parabola. The result is an approximately equal pressure drop at the end of admission in both cases. If shorter intervals had been used the results probably would have agreed still more closely. Although the admission line based on the parabola differs considerably from the shape of the actual admission line, it gives practically the same final pressure drop; and if the valve area is to be based on the latter the parabola may be used to advantage. It is assumed of course that the pressure at the admission valve is constant, which can be insured

by the proper amount of steam storage space around the valve and by steam pipes of sufficient size. If this is not provided then the total pressure drop at the end of admission increases by the amount of pressure loss at the inlet valve.

The drop of pressure at the end of admission corresponds to a certain throttling loss. The initial state of the steam  $p_1, v_1$  changes into  $p_2, v_2$  at the end of

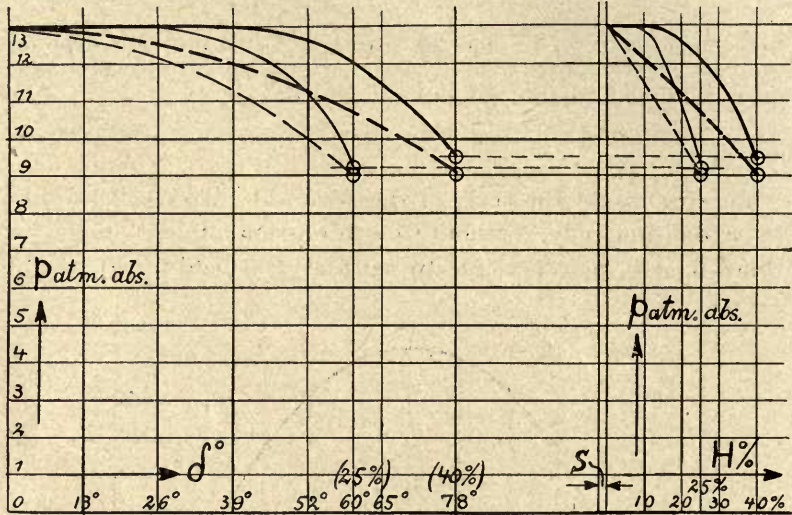


Fig. 17.

admission, and the subsequent expansion allows a part of this loss to be regained. The amount of this regain as well as the total final loss can be found from the temperature-entropy diagram (Fig. 2).

### Calculation of Exhaust Port Areas.

Throttling losses in the exhaust ports or valve and in the exhaust pipe are irretrievable because there is no subsequent expansion by which they may be regained. The dimensioning of the exhaust ports therefore requires particular caution. The loss in the diagram due to incomplete expansion will be dealt with later on. The point of interest at this time is the exhaust throttling loss caused by insufficient area of the exhaust passages, which makes itself noticeable by the rounding off of the end of the diagram as well as a narrow strip along the exhaust and compression lines. The latter part of this loss is especially harmful; it may be avoided by placing the condenser close to the cylinder, and making the connection between them, as well as the exhaust ports, of ample area (See pages 68—69.). Throttling losses in the exhaust are a minimum if the exhaust lead is made as small as possible and the pressures are completely equalized at the point of exhaust closure. Perfect equalization of pressure is most important. In order to reduce the exhaust lead to a minimum, the ports must occupy as much as possible of the cylinder circumference, only enough of the material being left to take the strain due to the piston load. This applies more particularly to condensing engines, while for atmospheric exhaust a small part of the circumference is suffi-



cient. Larger exhaust lead requires a smaller exhaust port area. When using large exhaust lead and atmospheric exhaust, one exhaust port is sufficient under certain conditions. (See chapter on Una-Flow Locomotives.) The requirement of perfect pressure equalization can be satisfied on the basis of the following calculation:

$$dQ = \varphi \cdot \omega \cdot F \cdot \gamma \cdot dt,$$

in which  $\varphi$  = coefficient of velocity,  $\omega$  = the velocity of the exhaust steam in m/sec,  $F$  = instantaneous value of the exhaust port area in sqm,  $\gamma$  = specific weight and  $t$  = duration of exhaust.

Even with highly superheated live steam, the exhaust steam of condensing engines is always, and that of non-condensing engines in most cases, saturated. The change of state within the cylinder can therefore be assumed to follow Mariotte's law:

$$p_1 \cdot v_1 = pv = p_2 v_2 = \text{const.}$$

$p_1, v_1, \gamma_1$  represents the state of the steam at beginning of exhaust,

$p, v, \gamma$  the state of the steam at any intermediate point,

$p_2, v_2, \gamma_2$  the state of the steam in the exhaust pipe (condenser, atmosphere, etc.),

$p_e, v_e, \gamma_e$  the state of steam at the narrowest place of exhaust port.

$x$  represents the piston travel in % of the stroke measured from the admission end.

As long as  $\frac{p_2}{p} \leq 0.577$  is  $p_e = 0.577 p$ . The value 0.577 remains about the same for any steam wetness. If  $p < 1.735 p_2$  then  $p_e = p_2$ . The change of the cylinder volume during exhaust is neglected. Since the weight of steam present in the cylinder is proportional to the absolute pressure,

$$\frac{p - dp}{p} = \frac{Q - dQ}{Q}; \quad Q = V \cdot \gamma; \quad dQ = \varphi \cdot \omega \cdot F \cdot \gamma_e \cdot dt$$

$$\frac{dp}{p} = \frac{dQ}{Q} = \frac{\varphi \cdot \omega \cdot F \cdot \gamma_e \cdot dt}{V \cdot \gamma} \quad \dots \dots \dots (1)$$

$$t = \frac{60 \cdot \delta}{n \cdot 360}; \quad dt = \frac{d\delta}{n \cdot 6} \quad (\delta = \text{crank angle corresponding to time } t)$$

$$\frac{dp}{p} = \frac{\varphi \cdot \omega \cdot F \cdot d\delta \cdot \gamma_e}{6 \cdot n \cdot V \cdot \gamma}; \quad V = \frac{\pi}{4} \cdot D^2 \cdot H \cdot (x + s); \quad A = D^2 \cdot H \cdot n$$

$$\frac{dp}{p} = \frac{0.2124 \cdot \varphi \cdot \omega \cdot F \cdot d\delta \cdot \gamma_e}{A \cdot (x + s) \cdot \gamma} \quad \dots \dots \dots (2)$$

### Range of High Pressures.

In this case  $p > p_{cr} = 1.735 p_2$ ,  $\omega = 3.23 \sqrt{pv} = 3.23 \cdot \sqrt{c}$ . For practical purposes it is sufficiently exact to replace the variable quantity  $(x + s)$  of equation 2 by the constant quantity  $(s + 1 - 0.5a)$ , where  $a$  = exhaust lead (the critical pressure is reached approximately at the dead center).

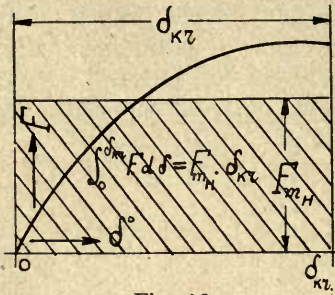


Fig. 18.

$$\gamma_e = \gamma \left( \frac{p_e}{p} \right)^{\frac{1}{x}} = \gamma \cdot 0.5777^{\frac{1}{x}} = \frac{\gamma}{1.62}$$

$$\frac{d p}{p} = \frac{0.2124 \cdot \varphi \cdot \sqrt{c} \cdot 3.23}{A \cdot (s + 1 - 0.5 a) \cdot 1.62} F \cdot d \delta$$

$$\int_{p_1}^{p_{cr}} \frac{d p}{p} = \frac{0.423 \cdot \varphi \cdot \sqrt{c}}{A (s + 1 - 0.5 a)} \int_0^{\delta_{cr}} F \cdot d \delta.$$

The quantities  $F$  for the range of high pressures may be plotted against  $\delta$  according to Fig. 18 and

$$\int_0^{\delta_{cr}} F \cdot d \delta = F_{mH} \cdot \delta_{cr}$$

$$\text{Then } \log_e \left( \frac{p_1}{p_{cr}} \right) = \frac{0.423 \cdot \varphi \cdot \sqrt{c}}{A (s + 1 - 0.5 a)} \cdot F_{mH} \cdot \delta_{cr}$$

$$F_{mH} \cdot \delta_{cr} = \frac{A}{\varphi} (s + 1 - 0.5 a) \cdot 5.45 \frac{1}{\sqrt{c}} \log_{10} \left( \frac{p_1}{1.735 p_2} \right) \dots (3)$$

$F$  in  $m^2$ ,  $A$  in  $m^3/min$ ,  $c$  in  $kg/m^2 \cdot m^3/kg$ .

For condensing una-flow engines with double-beat valves the average clearance may be assumed to be  $s = 0,03$  and  $\varphi = 0.9$  for drilled exhaust ports with well rounded edges; also  $A = 1$  in  $m^3/min$  and  $c = \sqrt{p_1 v_1} = 15000$

Therefore

$$F_{mH} \cdot \delta_{cr} = 0.0495 (1.03 - 0.5 a) \log_{10} \left( \frac{p_1}{1.735 p_2} \right) \text{ in } m^2 \dots (4)$$

For non-condensing una-flow engines also, the steam is in most cases saturated at exhaust and therefore

$$F_{mH} \delta_{cr} = 0.0457 (1.11 - 0.5 a) \log_{10} \left( \frac{p_1}{1.735 p_2} \right) \text{ in } m^2 \dots (5)$$

with  $p_1 v_1 = c = 17500$ ,  $s = 0.11$ ,  $\varphi = 0.9$ ,  $A = 1$ .

### Range of Low Pressures.

If  $p$  has been reduced to  $p_{cr} = 1.735 p_2$ , then  $p_e = p_2$  and

$$w = \sqrt{2 g \frac{x}{x-1} p v \left[ 1 - \left( \frac{p_2}{p} \right)^{\frac{x-1}{x}} \right]} \text{ and } \gamma_e = \gamma \left( \frac{p_2}{p} \right)^{\frac{1}{x}}$$

$$\text{Therefore } \frac{d p}{p} = \frac{0.2124 \cdot \varphi \cdot \sqrt{2 g \frac{x}{x-1} p v \left[ 1 - \left( \frac{p_2}{p} \right)^{\frac{x-1}{x}} \right]} \cdot \left( \frac{p_2}{p} \right)^{\frac{1}{x}}}{A (x + s)} \cdot F \cdot d \delta$$

Inserting  $1 + s - 0.5 a$  for  $x + s$  and  $c$  for  $p \cdot v$  the last equation may be written as follows:

$$\frac{dp}{p \cdot \sqrt{1 - \left(\frac{p_2}{p}\right)^{\frac{x-1}{x}} \left(\frac{p_2}{p}\right)^{\frac{1}{x}}}} = \frac{0.2124 \cdot \varphi \sqrt{2g \cdot \frac{x}{x-1} \cdot \sqrt{c}}}{A(s+1-0.5a)} \cdot F \cdot d\delta$$

$$\int_{p_{cr}}^{p_2} \frac{dp}{p \cdot \sqrt{1 - \left(\frac{p_2}{p}\right)^{\frac{x-1}{x}} \left(\frac{p_2}{p}\right)^{\frac{1}{x}}}} = \frac{0.942 \cdot \varphi \sqrt{c}}{A(s+1-0.5a)} \sqrt{\frac{x}{x-1}} \int_{\delta_{cr}}^{\delta_2} F \cdot d\delta$$

For  $\int_{\delta_{cr}}^{\delta_2} F \cdot d\delta = F_{mN} \cdot (\delta_2 - \delta_{cr})$  will be

$$F_{mN} (\delta_2 - \delta_{cr}) = \frac{A}{\varphi} 1.063 (s + 1 - 0.5 a) \frac{1}{\sqrt{c} \cdot \sqrt{\frac{x}{x-1}}} \int_{1.735 p_2}^{p_2} \frac{dp}{p \cdot \sqrt{1 - \left(\frac{p_2}{p}\right)^{\frac{x-1}{x}} \left(\frac{p_2}{p}\right)^{\frac{1}{x}}}}$$

The integral of this equation is independent of  $p_2$ , wherefore it may be written

$$\int_{1.735}^1 \frac{dp}{p \cdot \sqrt{1 - \left(\frac{1}{p}\right)^{\frac{x-1}{x}} \cdot \left(\frac{1}{p}\right)^{\frac{1}{x}}}}$$

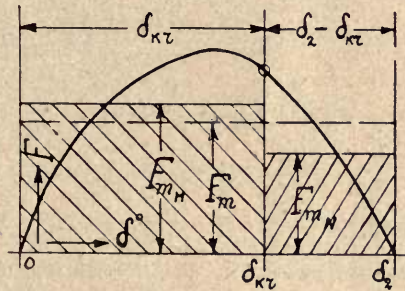


Fig. 19.

When integrating graphically the ordinate for  $p=1$  will be indefinite. By partial integration the integral may be written

$$\left[ p \frac{2x}{x-1} \sqrt{1 - \left(\frac{1}{p}\right)^{\frac{x-1}{x}}} \right]_{1.735}^1 - \frac{2x}{x-1} \int_{1.735}^1 \sqrt{1 - \left(\frac{1}{p}\right)^{\frac{x-1}{x}}} dp \dots (5a)$$

$$7.38 - 16.8 \int_{1.735}^1 \sqrt{1 - \left(\frac{1}{p}\right)^{\frac{x-1}{x}}} dp$$

and by graphical integration

$$7.38 - 16.8 \cdot 0.1315 = 5.17$$

$$\text{Consequently } F_{mN} (\delta_2 - \delta_{cr}) = \frac{A}{\varphi} 1.063 (s + 1 - 0.5 a) \frac{5.17}{\sqrt{c} \cdot \sqrt{\frac{x}{x-1}}}$$

$$= \frac{A}{\varphi \sqrt{c}} 1.895 (s + 1 - 0.5 a) \dots (6)$$

with  $F$  in  $m^2$ ,  $A$  in  $m^3/min.$ ,  $c$  in  $kg/m^2 \cdot m^3/kg$ .

For  $A = 1$  and  $\varphi = 0.9$  will be in condensing una-flow engines ( $c = 15000$ ;  $s = 0.03$ )

$$F_{mN} (\delta_2 - \delta_{cr}) = 0.0172 (1.03 - 0.5 a) \text{ in } m^2 \dots (7)$$

in non-condensing una-flow engines ( $c = 17500$ ;  $s = 0.11$ )

$$F_{mN} (\delta_2 - \delta_{cr}) = 0.0159 (1.11 - 0.5) \text{ in } m^2 \dots (8)$$

### Summary.

According to Fig. 19 the range of high and low pressures may be combined thus:

$$F_m \cdot \delta_2 = F_{mH} \cdot \delta_{cr} + F_{mN} (\delta_2 - \delta_{cr}).$$

and inserting the values from equations 3 and 6

$$F_m \delta_2 = \frac{A}{\varphi} \cdot \frac{5.45}{\sqrt{c}} (s + 1 - 0.5 a) \log_{10} \left( \frac{p_1}{1.735 p_2} \right) + \frac{A}{\varphi} \frac{1.895}{\sqrt{c}} (s + 1 - 0.5 a)$$

$$F_m \delta_2 = \frac{A}{\varphi} \cdot \frac{s + 1 - 0.5 a}{\sqrt{c}} \left[ 1.895 + 5.45 \log_{10} \left( \frac{p_1}{1.735 p_2} \right) \right].$$

For  $A = 1$  and  $\varphi = 0.9$  will be in condensing una-flow engines ( $c = 15000$ ;  $s = 0.3$ )

$$F_m = \frac{1.03 - 0.5 a}{\delta_2} \left[ 0.0172 + 0.0495 \cdot \log_{10} \left( \frac{p_1}{1.735 \cdot p_2} \right) \right] \dots \dots (9)$$

in non-condensing una-flow engines ( $c = 17500$ ;  $s = 0.11$ )

$$F_m = \frac{1.11 - 0.5 a}{\delta_2} \left[ 0.0159 + 0.0457 \log_{10} \left( \frac{p_1}{1.735 p_2} \right) \right] \dots \dots (10)$$

Neglecting the definite length of the connecting rod,  $\cos \frac{1}{2} \delta_2 = \frac{0.5 - a}{0.5} = 1 - 2a$ , whereby  $\delta_2$  can easily be calculated. Equations (9) and (10) should be used only, if  $p_1 \geq 1.735 p_2$  or  $p_1 < 1.735 p_2$  (*i. e.*  $\frac{p_1}{p_2} = 1.6$ ), the value (5a) should be integrated in smaller limits (*i. e.* 1.6 and 1) (*s.* upper corner in Fig. 20). In accordance herewith the second values of the brackets of equation (9) and (10) should be neglected, if they become negative.

An examination of engines with piston-controlled exhaust ports (not overrun by the piston) shows that

$$\frac{F_{\max}}{F_m} = \frac{h_{\max}}{h_m} = \frac{\pi}{2} \text{ approximately.}$$

The following table as well as Fig. 20 gives the values of  $F_m$  and  $F_{\max}$  (different scales) for the exhaust through the high and low pressure ranges for various values of exhaust lead  $a$  and pressure ratios  $\frac{p_1}{p_2}$ ,  $A$  being = 1, live steam pressure  $p_1 = 13$  at. abs.,  $t_1 = 300^\circ$ ,  $\varphi = 0.9$  and  $s = 3\%$  or  $11\%$  respectively for condensing and non-condensing engines. If the piston overruns the exhaust ports  $F_m$  should be used, otherwise  $F_{\max}$  should be taken. The insert in Fig. 20 represents exhaust in the low pressure range alone. Furthermore it is immaterial whether the exhaust ports are round or square. The shape of the exhaust ports has only little bearing upon the shape of the exhaust line and no bearing upon the terminal pressure. This is shown more clearly in Fig. 21, in which the dashed curves refer to round and the full curves to square exhaust ports. The conditions assumed are  $10\%$  exhaust lead, terminal expansion pressure 1.2 at. abs. and back pressure 0.05 at. abs. These curves show the slight deviation of the exhaust lines, which were calculated point by point by the interval method, as well as the fact that in both cases the same terminal pressure is reached.

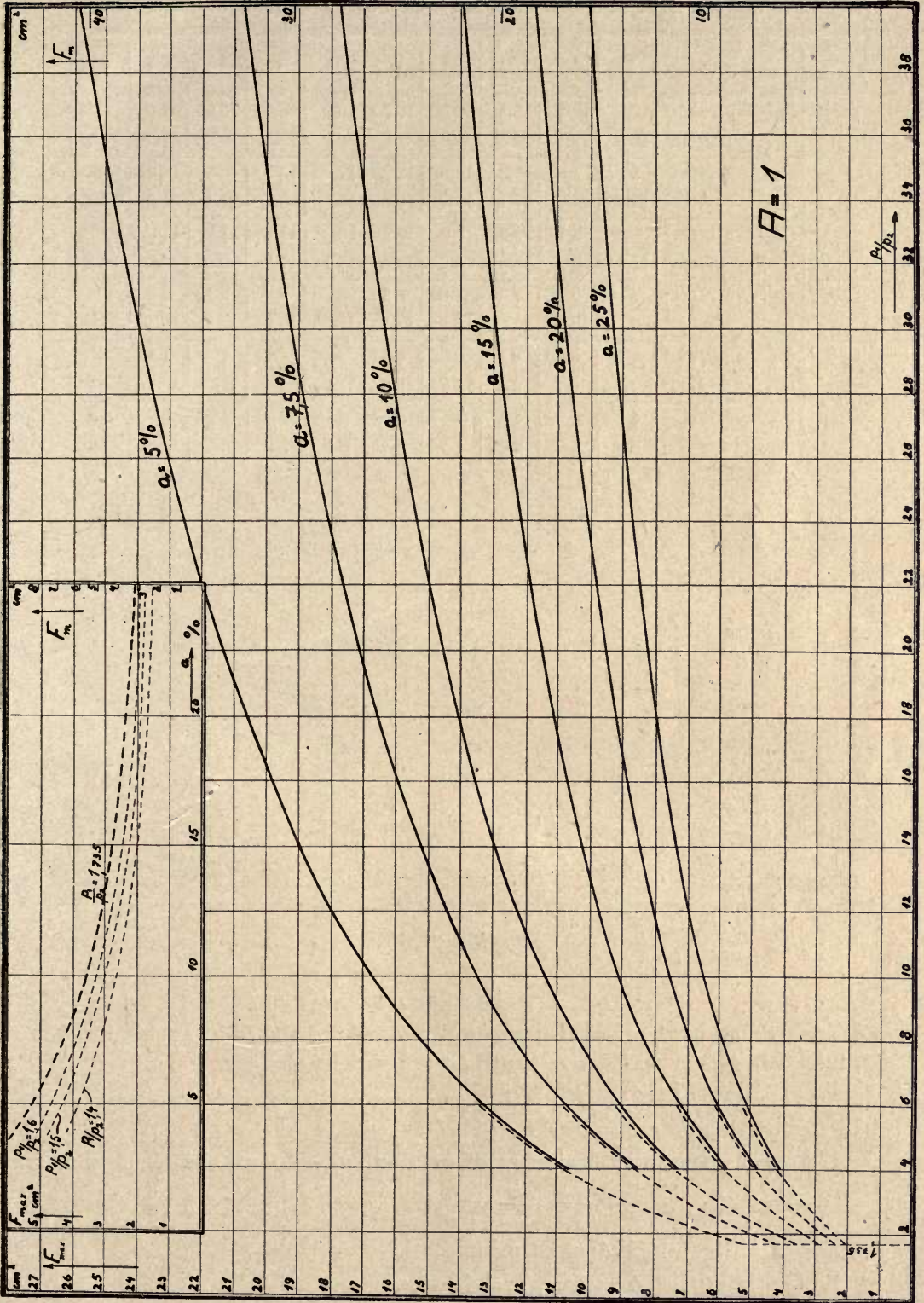


Fig. 20.

### Exhaust in high and low pressure range for condensing Engines.

$\frac{p_1}{p_2} =$	5	10	15	20	25	30	35	40	45	50	55	60
$a = 5\%$	$F_m = 7.76 \text{ cm}^2$	10.7	12.35	13.6	14.5	15.25	15.9	16.45	16.95	17.4	17.75	18.1
	$F_{\max} = 12.2 \text{ cm}^2$	16.8	19.4	21.4	22.8	24	25	25.8	26.8	27.3	27.9	28.4
$a = 7.5\%$	$F_m = 6.33 \text{ cm}^2$	8.57	9.99	10.9	11.6	12.25	12.75	13.2	13.6	13.95	14.25	14.55
	$F_{\max} = 9.95 \text{ cm}^2$	13.45	15.7	17.1	18.2	19.25	20	20.7	21.4	21.9	22.4	22.8
$a = 10\%$	$F_m = 5.3 \text{ cm}^2$	7.3	8.45	9.3	9.9	10.45	10.9	11.3	11.6	11.9	12.15	12.4
	$F_{\max} = 8.33 \text{ cm}^2$	11.45	13.25	14.6	15.5	16.4	17.1	17.7	18.2	18.7	19.1	19.5
$a = 15\%$	$F_m = 4.19 \text{ cm}^2$	5.78	6.67	7.33	7.82	8.25	8.58	8.9	9.15	9.4	9.6	9.8
	$F_{\max} = 6.58 \text{ cm}^2$	9.08	10.45	11.5	12.25	12.95	13.45	13.95	14.35	14.75	15.05	15.4
$a = 20\%$	$F_m = 3.49 \text{ cm}^2$	4.8	5.55	6.11	6.52	6.87	7.16	7.41	7.63	7.82	8	8.16
	$F_{\max} = 5.48 \text{ cm}^2$	7.54	8.7	9.6	10.2	10.8	11.25	11.65	11.95	12.25	12.55	12.8
$a = 25\%$	$F_m = 3.01 \text{ cm}^2$	4.14	4.79	5.27	5.62	5.92	6.18	6.39	6.58	6.75	6.9	7.04
	$F_{\max} = 4.72 \text{ cm}^2$	6.5	7.53	8.27	8.82	9.3	9.7	10	10.35	10.6	10.8	11.05

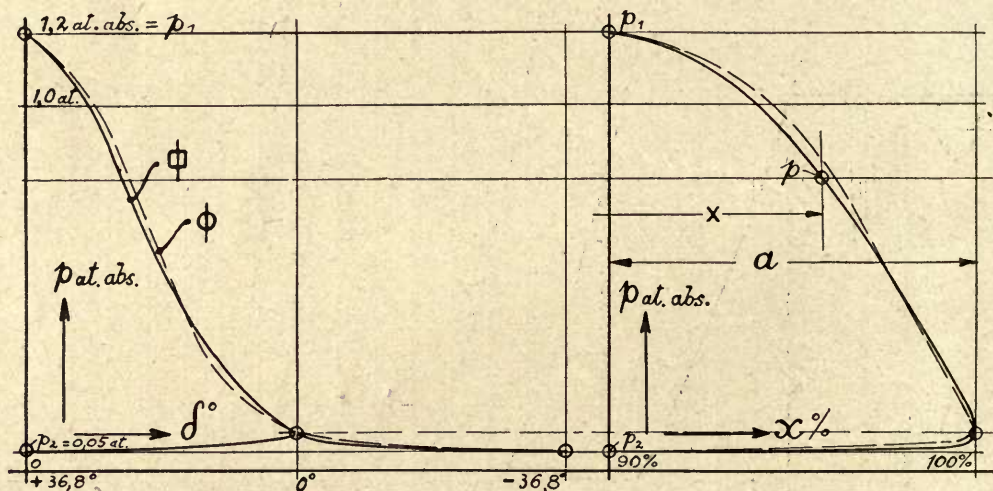


Fig. 21.

### Example.

The exhaust port area will now be calculated for the same engine for which the inlet valve area was determined in the previous chapter.

As before,  $D = 0.4 \text{ m}$ ,  $H = 0.5 \text{ m}$ ,  $r \cdot p \cdot m = 150$ , steam pressure = 13 at. abs., steam temperature =  $300^\circ \text{ C}$ .

1. Steam pressure at beginning of exhaust,  $p_1 = 1.6 \text{ at. abs.}$ , back pressure  $p_2 = 0.03 \text{ at. abs.}$ ; hence  $\frac{p_1}{p_2} = \frac{1.6}{0.03} = 53.4$ .

Also  $a = 10\%$ , and  $A = 12 \text{ m}^3/\text{min}$ .

From Fig. 20 for  $A = 1$ ,  $F_{\max} = 19 \text{ sqcm}$ .

Therefore for  $A = 12$ ,  $F_{\max} = 228 \text{ sqcm}$ .

Round ports with a diameter of  $d = 0.1 \cdot H = 5$  cm have an area of  $f = 19.635$  sqcm, and therefore the number required  $i = \frac{228}{19.635} = 11.7$  i.e. 12 holes.

2. For  $a = 5\%$  and  $\frac{p_1}{p_2} = 53.4$ ,  $F_{\max} = 334$  sqcm, and the number of ports required (2.5 cm diameter)  $i = 68$ . This number cannot be realized.

3. For  $a = 25\%$  and  $\frac{p_1}{p_2} = 53.4$ ,  $F_{\max} = 129$  sqcm. With a port diameter of 12.5 cm, the area of one port would be 122.7 sqcm and a single port would be almost sufficient.

4. For the same engine running non-condensing, the conditions may be  $p_1 = 3$  at. abs. and  $p_2 = 1$  at. abs., hence  $\frac{p_1}{p_2} = 3$ ,  $a = 20\%$ . Then according to Fig. 20,  $F_{\max} = 48.2$  sqcm, and one port of 10cm diameter having an area of 78.5 sqcm is therefore already too large.

The formula commonly used, based upon mean piston speed, would give the velocities  $w = 13.8$  m/sec in case 1,  $w = 9.4$  in case 2,  $w = 24.3$  in case 3, and  $w = 65$  in case 4. This proves the inadequacy of this formula.

In Fig. 22 is shown a diagram in which the admission and exhaust lines were calculated point by point after the areas for inlet and exhaust had been found by the above method, a drop of pressure at the inlet from 13 to 11 at. abs. and at the exhaust from 1.2 to 0.05 at. abs., 13% valve gear cut-off and 10% exhaust lead being assumed.

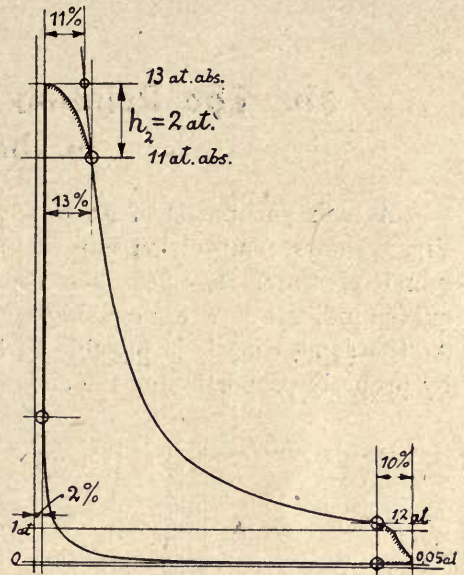


Fig. 22.

### 3b. The Relation of the Una-Flow Engine to the Condenser.

A high vacuum is of great advantage to the operation of una-flow engines. Fig. 1 shows compression curves for different back pressures and the same terminal pressure, the clearance volumes being correspondingly changed. These curves indicate how appreciably the diagram area increases with better vacuum. At the same time it is possible to keep the compression up to the desired value by properly proportioning the clearance volume. For a high vacuum the clearance

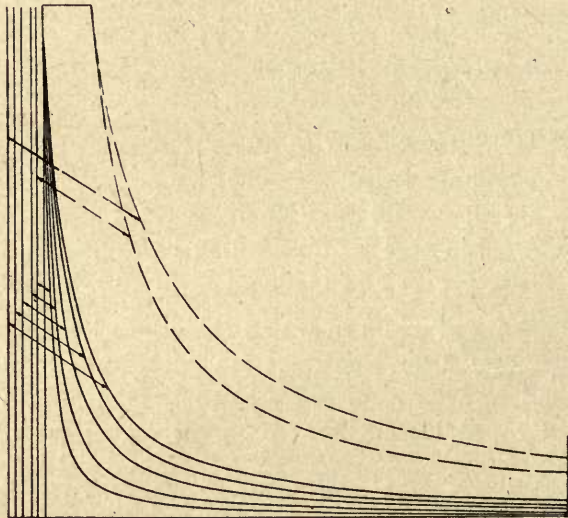


Fig. 1.

volume used may be very small. The limit is usually determined by the design, 2% being considered an average figure.

The duration of the exhaust of a una-flow engine with 10% exhaust lead and 90% length of compression is only about one half of the time available for the exhaust of a corresponding counterflow engine. The working steam of the una-flow cylinder must therefore be exhausted into the condenser in one-half the time. It is a fact that in the usual design of counterflow engines there exists a considerable pressure difference between the interior of the cylinder and the condenser, which is used to overcome the resistances in the usually too narrow exhaust passages. The shortening of the duration of the exhaust in the una-flow engine is all the more a reason for diminishing to the utmost the resistance between condenser and engine cylinder, and this can be accomplished by short passages



of large area. Furthermore, the exhaust port area of the una-flow cylinder can easily be made three times as large as the exhaust valve area of the ordinary counterflow engine. If now the remaining cross-sections have sufficient area to harmonize with these large exhaust port areas, and the length of the passages is kept down to the minimum, then complete pressure equalization will result. This is proved by experience as well as theory (See end of this chapter).

In Figs. 2 and 3 are shown a longitudinal and a cross section of a una-flow cylinder where the exhaust belt connects over its full width to the jet condenser placed immediately below it. The injection water enters by means of a perforated tube placed horizontally across the condenser. As may be seen from these illustrations, the exhaust passages are extremely short and wide so that there is practically no resistance.

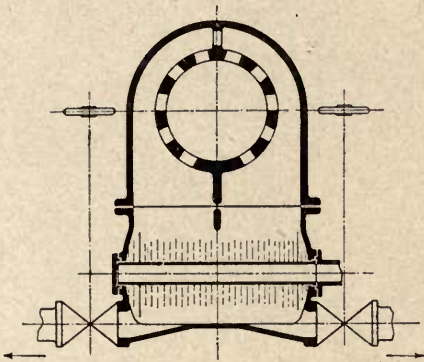


Fig. 2.

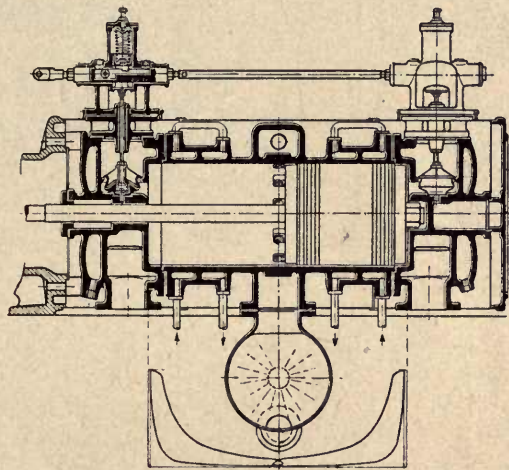


Fig. 3.

Figs. 4 and 5 show the application of a jet condenser of the Westinghouse-Leblanc type to a una-flow cylinder. This condenser and a similar one developed by the A. E. G. are based upon a principle which formed the substance of a patent issued to the author. The condenser body in this case forms the support for the engine cylinder. As in Figs. 2 and 3, this gives a very short connection and large transfer area, thus insuring equalization of pressure between the cylinder and condenser.

On account of this complete equalization, the compression begins at the lowest possible pressure with the result of a considerable gain of diagram area, a corresponding reduction of clearance volume and clearance surfaces, as well as increased thermal efficiency (Fig. 1). The short duration of the exhaust period due to the piston-controlled exhaust correspondingly reduces the cooling action of the condenser upon the interior of the cylinder. As soon as the exhaust ports are covered on the return stroke, the connection with the condenser is cut off, any further cooling is prevented and the heating effect of the steam jacket at the cylinder end comes into full play without any adverse influence due to the exhaust.

It is fundamentally wrong to interpose oil separators, change-over valves, feed water heaters or elbows in the connection between engine cylinder and con-

denser. Such accessories cause very large resistances to the flow of steam and should be avoided unless their use is rendered necessary by other important considerations.

The atmospheric exhaust pipe should be connected to the condenser body. If the connection between the condenser and air pump is shut off, the former

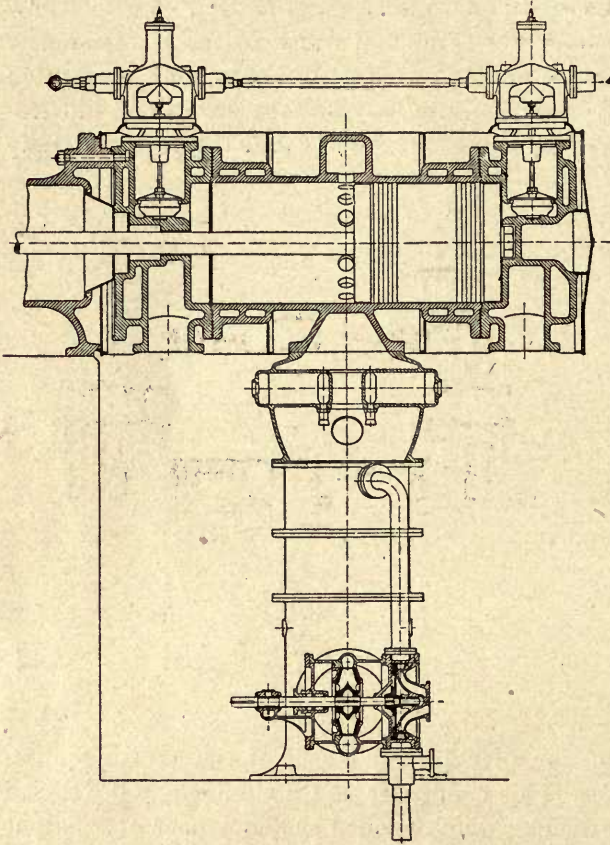


Fig. 4.

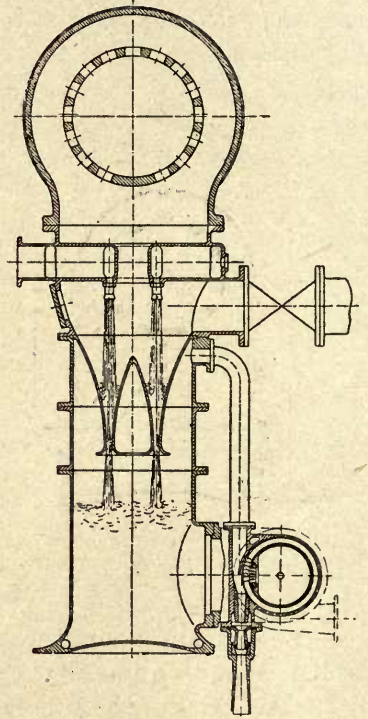
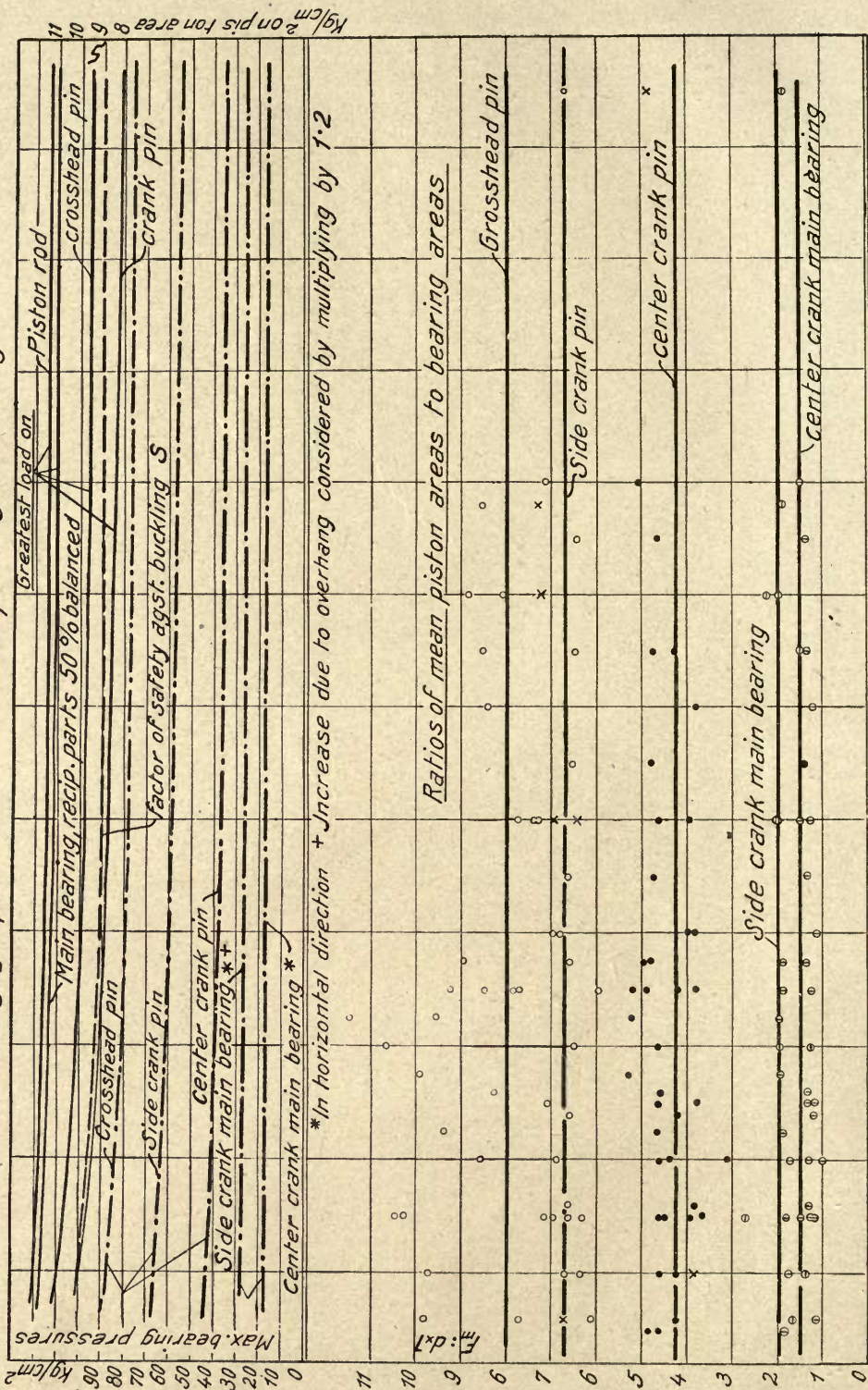


Fig. 5.

then acts as a kind of exhaust muffler or silencer (See Fig. 2). This silencer action should be assisted not only by the volume of the condenser but also by a change of direction of the steam flow. If no such provision is made, the loud exhaust will be very objectionable, as is shown by experience.



Average values for Stationary Una-flow Engines  
for gage pressure of 10-12 at., running condensing.



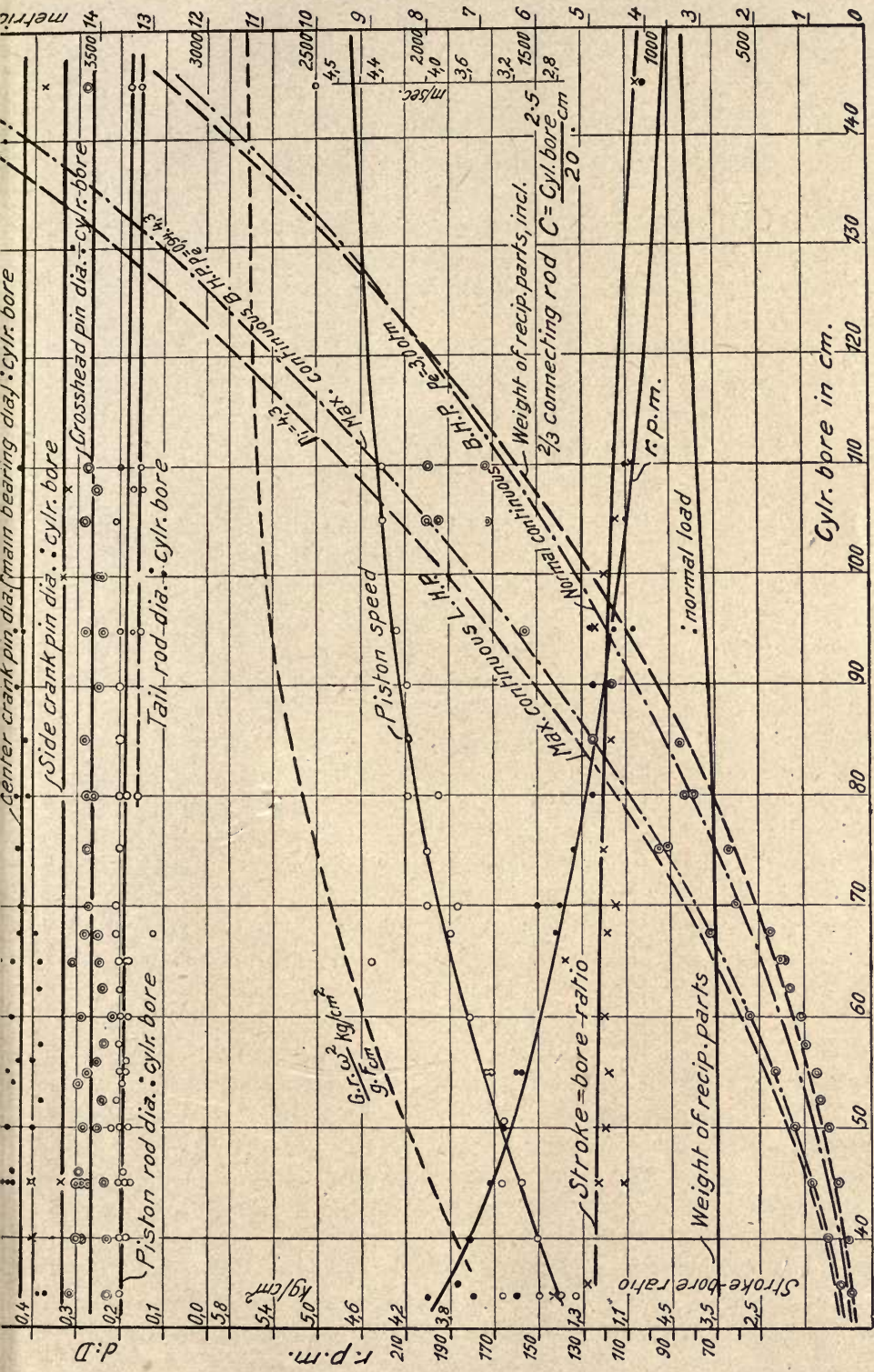


Fig. 1.



#### 4. Losses due to Friction. (Mechanical Efficiency.) Dimensioning of Driving Parts.

Very complete data are available for the dimensioning of driving parts of stationary una-flow engines. From these data have been compiled the curves shown in Fig. 1, which apply to steam pressures of from 10 to 12 at. gage, and condensing operation.

In Fig. 1 may be seen the weight of the reciprocating parts including two-thirds of the weight of the connecting rod, plotted against cylinder diameter. The average values may be represented by a curve according to the equation

$$G_{kr} = \frac{(\text{Cylinder dia. in cm})^{2.5}}{20}$$

The weight of the piston is about  $\frac{3}{10}$ , that of the connecting rod  $\frac{2}{7}$  of the total weight of the reciprocating parts.

Since the ratio of stroke to cylinder bore is the determining factor for the reciprocating weights, the ratio of stroke to cylinder bore is also shown in this chart. It will be observed that small engines have a proportionally long stroke, while large engines have a proportionally shorter stroke. Since the average buyer of engines generally has a prejudice against what may be called high speed in the sense of high number of revolutions per minute, regardless of piston speed, small engines are therefore built with a comparatively long stroke. For large engines a high number of revolutions is usually demanded, and since the majority of builders have a similar dislike for high piston speeds, an engine of short stroke is the result. It seems strange, however, that the type of frame used does not appear to have any bearing whatever upon the bore and stroke ratio although some designers are inclined to make side crank engines with long, and center crank engines with short strokes (See Fig. 1).

The piston speed based on cylinder diameter shows a more rapid increase for the smaller sizes than for the larger ones.

The maximum continuous load rating of una-flow engines usually corresponds to a mean effective pressure of about 4.5 kg/sqcm. If the mechanical efficiency for this load is assumed to be 0.94, then the figures for the HP output obtained agree closely with those given by the makers. The normal rating usually corresponds to a mean effective pressure of 3 kg/sqcm based on brake HP. This figure is evidently a compromise between high economy and low initial cost.

The lowest curve in Fig. 1 represents weight of reciprocating parts divided by rated brake HP. The values show small variation (3.45 to 4.15 kg/BHP) but increase gradually with the cylinder bore.

The curve between 3.6 and 5.6 kg/sqcm represents inertia of reciprocating parts for an infinite length of connecting rod.

Fig. 2 gives first an indicator card having an MEP of 4.3 kg/sqcm corresponding to the maximum continuous load. From this card are developed three net pressure diagrams containing inertia curves plotted for a length of connecting rod equal to five times the crank radius, for three different cylinder bores of 500,

*Net pressure and Inertia force Curves.*

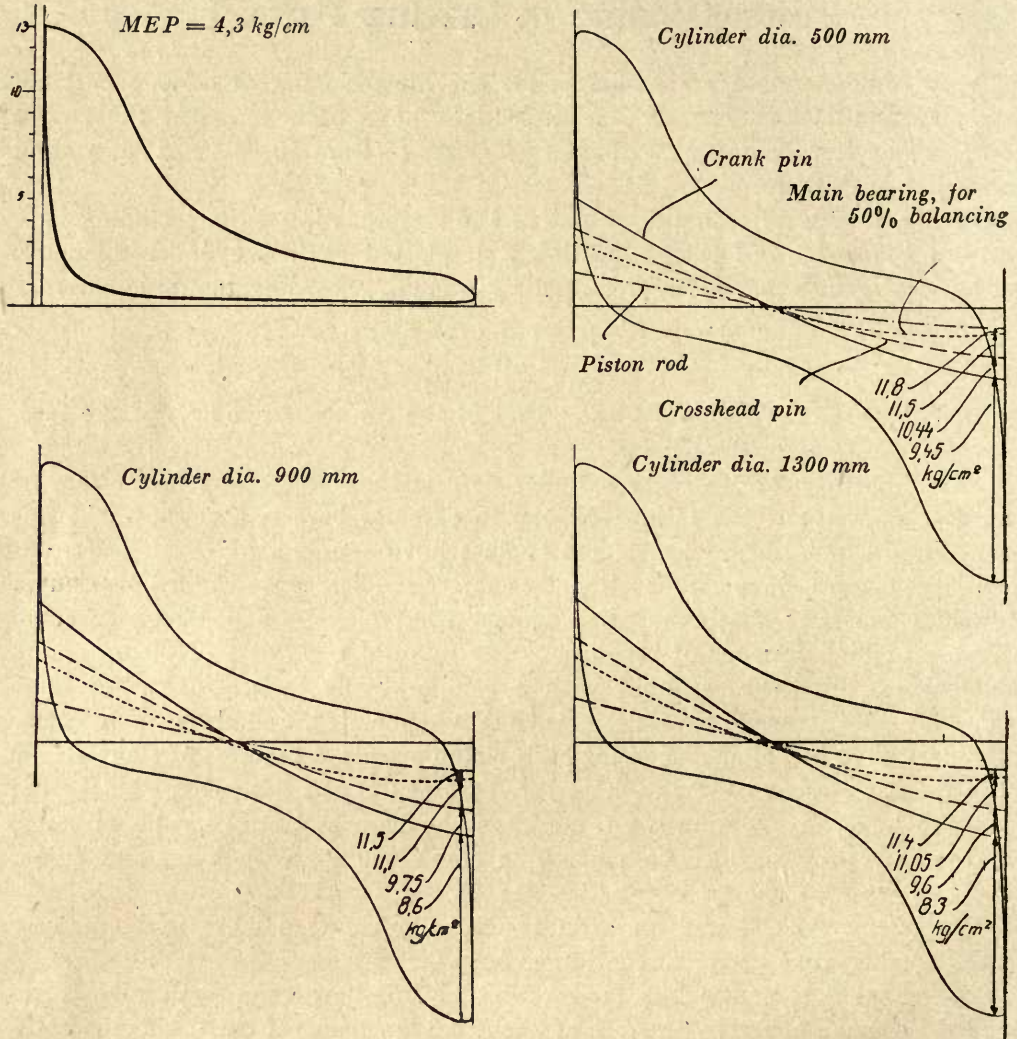


Fig. 2.

900 and 1300 mm. For any piston position the vertical distance between inertia curve and net pressure line represents the load upon that driving part to which the inertia curve refers. The dashed and dotted lines apply to the load on the piston rod, the dashed lines to the crosshead pin, and the full lines to the crank pin. The dotted curves in the same way give the load on the main bearings, 50% of the weight of the reciprocating parts being balanced. For center crank shafts two equally loaded main bearings of equal size are assumed, while for side crank



shafts the main bearing loads have been increased by about 20% on account of the overhang. In regard to bearing load, apart from impact, it would be more advantageous if the inertia forces for the smaller engines would correspond to those of the larger size in the last diagram of Fig. 2; and this could be accomplished by increasing the speed, for an engine of 500 mm cylinder bore, from 162 r. p. m. to say 188 r. p. m.

The proportions of piston rod and tail rod as well as diameters of the different bearings are plotted as functions of the cylinder bore. It will be noted that the ratio of piston rod diameter to cylinder bore is slightly less for engines of large size, by reason of the proportionally shorter stroke of the latter. The distance from rear end of piston to center of crosshead pin is usually about 3.33 times the stroke. The factor of safety against buckling of the piston-rod, based on the loads represented in the diagram of Fig. 2, is 10 for small engines and 9 for larger engines.

#### Average ratios.

Crosshead pin diameter to cylinder bore . . . . .	0.265
Side crank, crank pin diameter to cylinder bore . . . . .	0.33
Side crank, main bearing diameter to cylinder bore . . . . .	0.5
Center crank, crank pin diameter to cylinder bore . . . . .	0.425
Center crank, main bearing diameter to cylinder bore . . . . .	0.425
Length of crosshead pin to its diameter . . . . .	1.3—1.6
Side crank, crank pin length to its diameter . . . . .	1.0—1.2
Center crank, crank pin length to its diameter . . . . .	0.9—1.0
Side crank, main bearing length to its diameter . . . . .	1.3—1.8

The crank pin diameter of center crank shafts will be found only in rare cases to be larger than the diameter of the main bearing, and the main bearing at the flywheel side longer than the opposite main bearing.

Fig. 1 further shows the ratios of piston area to bearing areas  $\frac{F}{(l \cdot d)}$  which give the following averages: Crosshead pin 8, side crank, crank pin 7.7, center crank, crank pin 4.25, side crank, main bearing 1.95, and each main bearing of center crank shafts 1.5.

Combining these data with the specific loading taken from the diagrams in Fig. 2, the resultant bearing pressures were calculated and are shown at the top of Fig. 1. These values refer to maximum continuous load and smallest dead center inertia, horizontal forces only being considered. Strictly speaking, the additional forces due to flywheel weight, belt pull, etc. should be combined with the horizontal forces, but this would not materially alter the results. It will be seen that crank pin and main bearings of side crank shafts sustain about 50% higher loading than the corresponding bearings of center crank shafts. The highest bearing pressures given in Fig. 1 are undoubtedly permissible in case of force feed lubrication.

On side crank shafts, excessively large leverages, i. e. distances from the connecting rod center to the main bearing center, cause increased bending, higher

bearing pressure and on account of the deflection of the crank shaft, increased pressure at the inside edge of the main bearing. This tendency can be reduced by shortening the leverage or the use of self aligning bearings, or both (Fig. 3). Since there are no secondary forces acting on the connecting rod in the horizontal plane, the factor of safety against buckling in this plane need not be more than 5, as against a factor of 9 or 10 in the vertical plane. This condition can be easily met by flattening the otherwise circular rod section. The crank hub should be

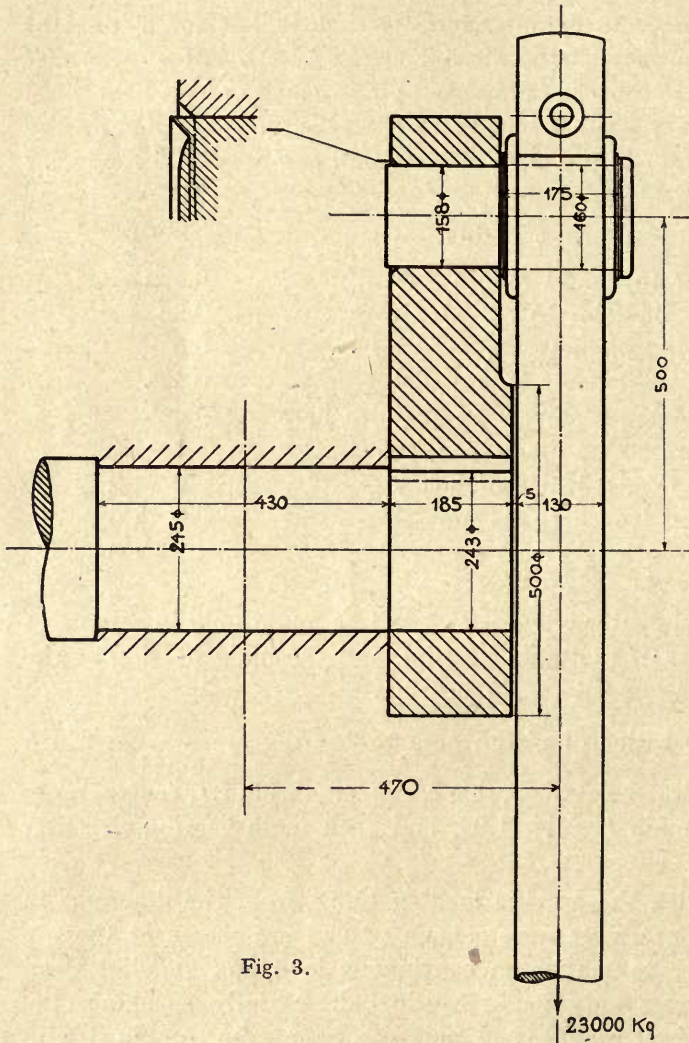


Fig. 3.

placed as close as possible to the connecting rod and should not be wider than 0.65 times the shaft diameter for large engines and 0.75 for small engines. On some large Belgian engines this figure is even cut down to 0.6. The projecting part of the crank pin bearing corresponds to the projecting part of the crank hub. The rear side of the crank in this case becomes flat. The crank is frequently pressed in place on the shaft, although a shrink fit is preferable by reason of the lesser chance of damage to the structure of the material. A key, although frequently used, is unnecessary. The same applies to the connection of the crank pin to the crank arm, and the former should be ground after assembly.

A still shorter overhang may be obtained by casting crank, crank pin and crank shaft in one

piece of cast steel. By designing the crank in the form of a disc, as shown in Fig. 4, an especially large reduction in the overhang may be obtained, with a corresponding decrease in the shaft diameter. The present state of foundry practice allows such a construction to be used without anxiety.

Constructional data of a stationary una-flow engine built by Sulzer Bros. and installed in a cotton spinning mill at Crefeld are as follows: Cylinder bore

1100 mm, stroke 1200 mm, speed 110 r. p. m., steam pressure 12 at. gage, steam temperature 320°. The engine is of the center crank type.

Main bearings, 475 mm dia. by 650 mm long  
 Crank pin, 475 mm dia. by 380 mm long  
 Crosshead pin, 300 mm dia. by 430 mm long  
 Piston rod 220 mm diameter, tail rod 170 mm diameter  
 Weight of piston 2125 kg, weight of piston rod 1500 kg  
 Weight of crosshead 1532 kg,  $\frac{2}{3}$  connecting rod 1780 kg  
 50% of the reciprocating parts are balanced  
 by counterweights fastened to the crank  
 cheeks.

The friction HP of this engine at 110 r. p. m. with a smooth flywheel was 113,6. The corresponding mechanical efficiency for a rated load of 1700 IHP is therefore 0.933, a figure which disproves the opinion frequently advanced that the mechanical efficiency of una-flow engines is low. The assumption that the engine friction must be nearly independent of the HP output is based on the fact that the load on the driving parts is practically the same for idling as it is for the rated HP. Starting with the engine idling, and gradually increasing the output, the gross load on the driving parts first decreases slightly, at rated output reaches the same value as for idling, and then becomes somewhat greater for larger output.

The engine at Crefeld, for instance, has a dead center inertia load of approximately 6 kg/sqcm, a corresponding mean pressure of the inertia diagram of 3 kg/sqcm, and a useful rated mean effective pressure of 3 kg/sqcm. It follows that the engine friction for idling and rated output must be the same. Further, the weight of the piston, flywheel, crank shaft and the rest of the driving parts as well as the centrifugal force of the connecting rod end, crank and counterweights are responsible for a constant portion of the total friction.

The above will be further illustrated by the following test results obtained by Sulzer Bros.

A una-flow engine of 700 mm cylinder bore and 900 mm stroke, having a rope flywheel of 4000 mm diameter, gave the following friction at different speeds (without ropes).

133	112	100	85	68 r. p. m.
66	53	46	38	28 IHP friction.

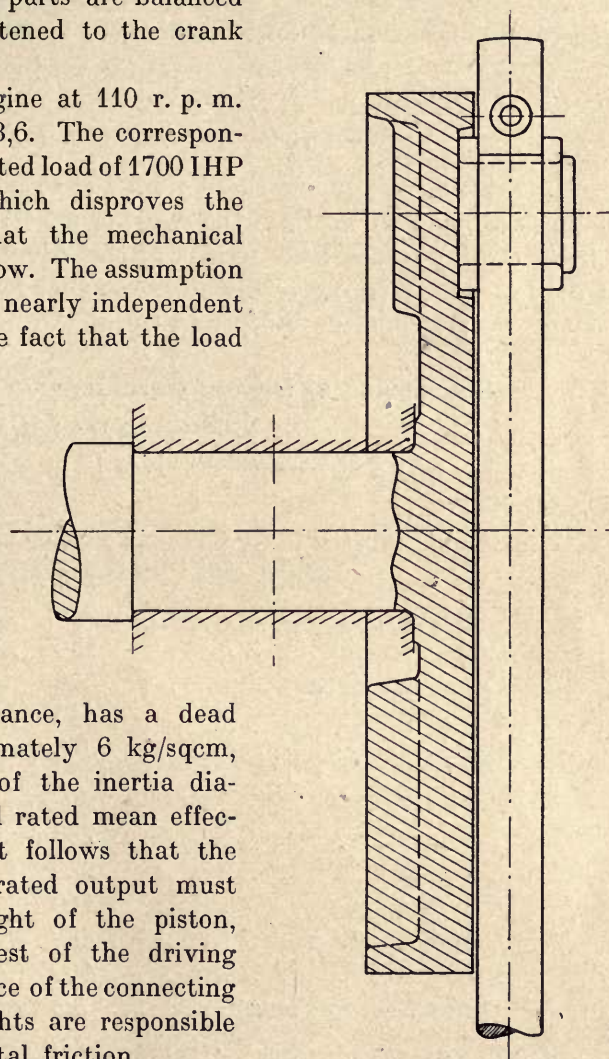


Fig. 4.

The corresponding rated load would be

	820	690	615	520	420 IHP,
so that the friction HP in % would be	8	7.7	7.5	7.3	6.7%.

Another engine of 600 mm cylinder bore and 725 mm stroke, fitted with a rope flywheel of 2400 mm diameter, with 14 grooves, gave the following results:

	150	100	50	34 r. p. m.
	41	22	8.5	4.5 IHP friction.

The corresponding rated load in this case would be

	475	317	158	108 IHP,
so that the friction HP in % is	8.65	7	5.4	4.15%.

In reducing the engine speed from 150 to 50 r. p. m. the friction HP should diminish from 41 HP to  $\frac{1}{9}$  of the same, or 4.5 HP. It actually was 8.5 HP, which reflects the influence of the weight of the driving parts. The weight and inertia of the latter have an equalizing effect, so that for constant speed the friction HP remains nearly constant independently of the instantaneous output.

### Dimensions of Driving Parts of Other Una-Flow Engines- (Sulzer Bros. design.)

Steam pressure at admission valves 12 at. gage. All bearings have force feed lubrication.

1. 550 mm cylinder bore, 650 mm stroke, 158 r. p. m.

Two main bearings . . . . .	250 mm dia.	by 360 mm long
Crank pin . . . . .	250	,, ,, ,, 200 ,, ,,
Crosshead pin . . . . .	150	,, ,, ,, 220 ,, ,,
Crosshead shoes . . . . .	520	,, long ,, 300 ,, wide
Piston rod . . . . .	110	,, dia.
Connecting rod length . . . . .	5.5 times the crank radius.	

2. 500 mm cylinder bore, 600 mm stroke, 165 r. p. m.

Two main bearings . . . . .	230 mm dia.	by 330 mm long
Crank pin . . . . .	230	,, ,, ,, 180 ,, ,,
Crosshead pin . . . . .	140	,, ,, ,, 200 ,, ,,
Crosshead shoes . . . . .	480	,, long ,, 275 ,, wide
Piston rod . . . . .	100	,, dia.
Connecting rod length . . . . .	5.5 times the crank radius.	

3. 850 mm cylinder bore, 1000 mm stroke, 125 r. p. m.

Two main bearings . . . . .	375 mm dia.	by 550 mm long
Crank pin . . . . .	375	,, ,, ,, 310 ,, ,,
Crosshead pin . . . . .	240	,, ,, ,, 350 ,, ,,
Crosshead shoes . . . . .	800	,, long ,, 500 ,, wide
Piston rod . . . . .	150	,, dia.
Connecting rod length . . . . .	5.5 times the crank radius.	

Sulzer Bros. also mention the fact that they have found the friction HP of their una-flow engines equal or slightly less than the friction HP of their tandem compound engines of equal power.

The driving parts of a una-flow engine should naturally cause more friction than the parts of a tandem compound engine since the size, or rather diameter, of the bearings of a una-flow engine is larger on account of the higher piston load. In a una-flow engine the single piston carries live steam pressure, while the low pressure piston of a tandem compound engine only carries receiver pressure and the much smaller high pressure piston sustains the difference between the live steam and receiver pressures. On the other hand, the single una-flow cylinder with its one piston and one or two piston rod packings will cause less friction than the two cylinders with two pistons and three or four rod packings of the tandem counterflow engine. Steam cylinders arranged in tandem are furthermore subject to misalignment with accompanying binding of the moving parts, and the friction

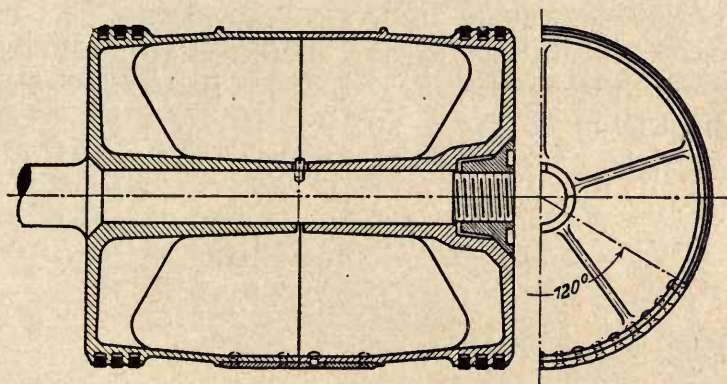


Fig. 5.

caused by such misalignment may be considerable. The piston system in una-flow engines can always be supported at two points only, for instance by means of a crosshead and self-supporting piston, or on crosshead and tail rod support with floating piston. It is assumed of course that the metallic packing used is of such design as to permit of lateral movement of the piston rod. Furthermore, the tandem counterflow engine requires four times the number of steam distributing elements as the una-flow engine (8 valves against 2 valves), with a corresponding increase in friction. A comparison between a una-flow and a cross-compound engine will still further emphasize the advantages of the una-flow system. According to what is said above, the lesser friction of the una-flow cylinder must outweigh the increased friction of the una-flow driving parts, if the experience of Sulzer Bros. is accepted as having general application.

That part of the engine friction caused by the piston, especially if self-supporting, may be considerable. This friction may be reduced by fitting the piston with shoes of bronze, babbitt or Allan Metal. The friction is least with a floating piston, i. e. a piston supported by its rod, despite the additional friction of the second stuffing box and tail rod support.

The una-flow piston should be made as light as possible, and this may be accomplished by constructing it in two parts of cast steel (See Fig. 5), thereby reducing friction, inertia and impact.

Next to the piston, the main bearing, crank pin and crosshead pin contribute the largest share to the total friction. The friction of high grade metallic packings is extremely small, as is also the friction of the poppet valves and their gear. This applies especially to una-flow engines with only two valves and one packing.

The friction of the driving parts can be considerably reduced by a proper oiling system, especially by means of force feed lubrication. The latter type also reduces impact. The provision of force feed lubrication for the condenser pump driving parts and the use of a housing around the flywheel are further measures in the right direction.

Short stroke engines with bearings of large diameter naturally have a higher friction loss than long stroke engines.

In engines having steam jackets on the cylinder barrel the friction is usually greater if the jackets are shut off. In the same way a new engine while being run in will have more friction than later, and the friction of an engine immediately after starting will be larger than when in regular operation, especially if it has not been warmed up previously.

Taking it altogether one may say that *the una-flow engine has a slightly better mechanical efficiency than the ordinary tandem compound engine.*

## 5. Losses due to Leakage.

### Valves, Pistons, Piston Rod Packings.

Tight steam distributing organs are a rare exception. Slide valves are generally considered to be tighter than piston valves, this being the reason for the practice of many concerns to use piston valves for the high pressure and slide valves for the low pressure cylinders, a practice which is also supported by pressure and temperature considerations.

Corliss valves are fairly tight, but they are far from being absolutely tight.

Well made piston valves fitted with snap rings may be considered fairly tight. Piston valves without rings should only be used in small sizes for saturated steam and must be made a good fit. Larger piston valves for use with superheated steam should always be equipped with snap rings on account of the necessary clearance required for expansion. Even then a certain amount of leakage must be expected in those positions in which none or one ring only is active, in addition to the constant amount of leakage past the ring joints. In case of highly superheated steam, carbonized oil may be the cause of increasing leakage.

Double beat valves are usually leaky. The leakiness increases with the amount of balance, the pressure and the temperature. With all types of valves leakiness will be enhanced with increasing superheat, on account of warping and the increasing fluidity of the steam.

The body of double-beat valves as shown in Figs. 1, 2 and 3 will sustain a heavy load in the direction of the axis during the expansion and exhaust periods. The corresponding deflection will cause the lower face of the valve to leave its seat and leak. The radial forces can be neglected if the seats are made flat.

In the same way, if the temperature of the valve is higher than the temperature of the material forming its housing and seat, then the valve body will expand more than the latter, and the upper valve face will lose contact and start to leak. The above temperature difference may have several causes. In a valve design as shown in Fig. 1, in which valve and seat have the same height and the same thickness of material, equal expansion, in the most favorable case, will

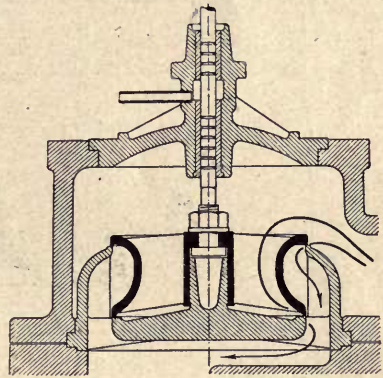


Fig. 1.

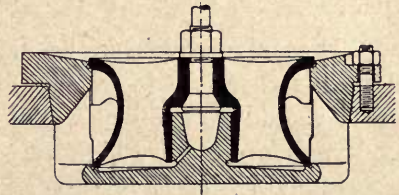


Fig. 2.

occur only if the material of both parts has the same coefficient of expansion. This can be realized by due attention to the work of the foundry. Both parts are exposed to live steam temperature on one side and to the varying temperature of the cylinder steam on the other.

Conditions are not so good in the design shown in Fig. 2, in which a valve cage of the ordinary type is used. Valve and seat are of different thicknesses and therefore expand unequally, especially during the first period after starting. Furthermore, the two parts will have different temperatures during operation, since the valve is exposed on one side to live steam, while the cage is entirely surrounded by cylinder steam.

The most unfavorable design is the one shown in Fig. 1, page 4, which has the valve seats cast in one piece with the cylinder head. The difference in expansion between valve and seat, especially just after starting up, must be considerable. The coefficients of expansion and the mean temperature of both parts will certainly be different and the corresponding leakage will therefore be considerable.

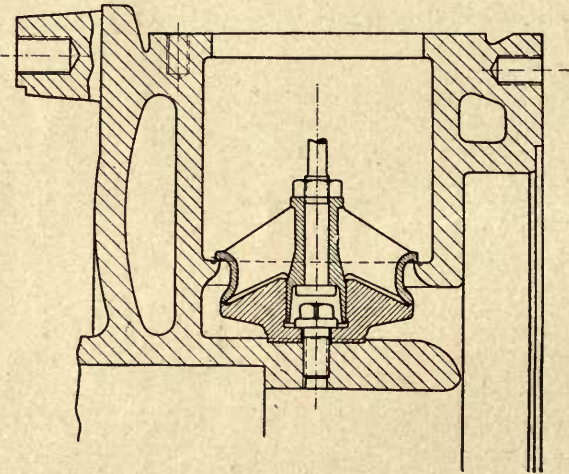


Fig. 3.

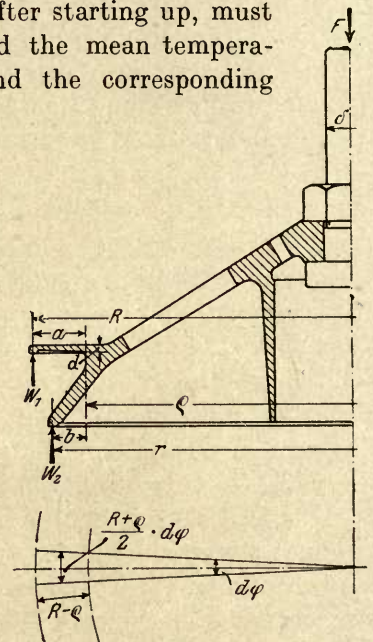


Fig. 4.

The valve will leak the more, the higher it is. The first rule in poppet valve design is therefore to make the valve as low as possible. For this reason, valve gears should be avoided which at late cut-offs give unnecessarily large valve lifts and therefore require high valves, unless a restriction of the upper passage is not objectionable. It is further advisable in cases where valve cages or similar constructions are objected to on the ground of the number of tight joints required, to use a kind of saucer to form the lower valve seat, thus at the same time reducing the height of the valve. (See Fig. 3.) In this design the vertical forces as well as the deflection of the valve body are reduced on account of its small height and the small radial width of the valve ring. By grinding in at the operating temperature, a close approximation to complete tightness for one particular pressure and temperature will be obtained. During the first period after starting and at any other pressure and temperature the valve will leak. Perfect tightness under



all conditions can be accomplished with a resilient valve such as is shown in Fig. 4. The lower valve face is smaller in diameter than the upper one. This difference produces a force in addition to the spring load, which tends to press the lower rigid face as well as the resilient upper face against the corresponding seats. The upper resilient face also takes care of unequal expansion. In order to make the valve low and to reduce its deflection, a saucer forming the lower valve seat may be used to advantage. Dirt in the steam, however, may cause leakage even with this type of valve.

### Theory of the Resilient Valve.

The following forces act on the valve:

Downwards:

1. The spring pressure minus the steam pressure on the stem,

$$P = F - \frac{\delta^2 \pi}{4} (p_a - 1)$$

where  $p_a$  is the absolute pressure in the valve chest.

2. The pressure on the upper side of the resilient annular ring,

$$(R^2 - \varrho^2) \pi (p_a - p_i)$$

where  $p_i$  is the absolute pressure in the cylinder.

Upwards:

3. The pressure on the lower side of the lower annulus

$$(r^2 - \varrho^2) \pi (p_a - p_i).$$

4. The upward reaction of the upper valve seat  $W_1$ .

5. The upward reaction of the lower valve seat  $W_2$ .

The horizontal forces balance each other.

The sum of the vertical forces must be zero, so that

$$P + (R^2 - \varrho^2) \pi (p_a - p_i) - (r^2 - \varrho^2) \pi (p_a - p_i) - W_1 - W_2 = 0 \quad (1)$$

If the radii, the steam pressures and the spring pressure are known, only the bearing reactions  $W_1$  and  $W_2$  remain unknown.

$W_1$  may be found from the condition that the deflection  $f_1$  of the resilient ring due to the steam pressure (measured at the middle of its face), must be equal to the deflection  $f_2$  caused by the seat reaction  $W_1$ , provided the lower valve face is to remain on its seat. Therefore  $f_1 = f_2$ .

Imagining a piece cut out radially from the valve with the angle  $d\varphi$  at the center, then the steam pressure acting on this element of the resilient surface is

$$\left( \frac{R + \varrho}{2} \right) \cdot d\varphi (R - \varrho) \cdot (p_a - p_i),$$

and the corresponding deflection is

$$f_1 = \left( \frac{R + \varrho}{2} \right) \cdot d\varphi \cdot (R - \varrho) (p_a - p_i) \frac{(R - \varrho)^3}{8 E \cdot J} \quad (2)$$

where  $E$  = the modulus of elasticity and  $J$  = the moment of inertia (approximately constant) of the cross-section at right angles to the plane of bending.

The seat reaction on the radial element under consideration is  $W_1 \cdot \frac{d\varphi}{2\pi}$ , and the corresponding deflection is

$$f_2 = W_1 \cdot \frac{d\varphi}{2\pi} \cdot \frac{(R - \varrho)^3}{3E \cdot J} \dots \dots \dots (3)$$

Then on equating  $f_1 = f_2$

$$W_1 = \frac{3}{8} \pi (R + \varrho) (R - \varrho) (p_a - p_i) \dots \dots \dots (4)$$

From equation (1)

$$W_2 = P + (p_a - p_i) (R^2 \pi - r^2 \pi) - W_1 \dots \dots \dots (5)$$

Substituting in (5) the value of  $W_1$  as found in (4), then

$$W_2 = P + \left( \frac{5}{8} R^2 - r^2 + \frac{3}{8} \varrho^2 \right) \pi (p_a - p_i) \dots \dots \dots (6)$$

In the limit, when the valve just rests on the lower seat,  $W_2 = 0$ . Neglecting  $P$ , the excess of the spring pressure over the steam pressure on the valve stem, the highest permissible value for  $\varrho$  may be obtained from the following equation:

$$\frac{5}{8} R^2 - r^2 + \frac{3}{8} \varrho^2 = 0 \dots \dots \dots (7)$$

Denoting  $R$  by  $\varrho + a$ , and  $r$  by  $\varrho + b$ , equation (7) becomes

$$\frac{5}{8} (\varrho + a)^2 - (\varrho + b)^2 + \frac{3}{8} \varrho^2 = 0$$

$$\frac{10}{8} \varrho \cdot a + \frac{5}{8} a^2 - 2\varrho b - b^2 = 0$$

$$\frac{5}{8} a (a + 2\varrho) - b (b + 2\varrho) = 0,$$

or since  $a + 2\varrho$  and  $b + 2\varrho$  are approximately equal,

$$b = \frac{5}{8} a \dots \dots \dots (8)$$

If the valve expands by the amount  $\Delta l$  in excess of the casing, in consequence of unequal temperatures and coefficients of expansion, the resilient ring must deflect by the same amount in order to remain steam tight. In this case  $f_1 - f_2$  is not zero but is equal to

$$\Delta l = f_1 - f_2 \dots \dots \dots (9)$$

The seat reaction  $W_1$  for any given  $\Delta l$  is obtained by inserting the values for  $f_1$  (from equation 2) and  $f_2$  (from equation 3) in equation 9; hence

$$W_1 = \frac{\pi}{2} \left( \frac{3}{4} (R^2 - \varrho^2) (p_a - p_i) - \Delta l \cdot E \cdot \varrho \left( \frac{d}{R - \varrho} \right)^3 \right) \dots \dots (10)$$

For the valve to be tight,  $W_1$  must be positive, for which purpose a pressure difference  $(p_a - p_i)$  is necessary, as may be seen from equation (10). The minimum pressure difference required for tightness may be obtained from equation (10) by making  $W_1 = 0$ , i. e.

$$p_a - p_i = \frac{4 \Delta l \cdot E \cdot \varrho}{3 (R^2 - \varrho^2)} \left( \frac{d}{R - \varrho} \right)^3 \dots \dots \dots (11)$$

From this equation it will be seen that the pressure difference is proportional to  $\Delta l$  and consequently to  $l$ . In order to keep  $(p_a - p_i)$  small, the valve must be low. The dimension  $d$  is determined by the strength of the material, and the values of  $R$  and  $\rho$  by the desired steam velocity.

To find the bending stresses of the resilient ring during operating conditions; let

- $t_1$  = the temperature of the valve,
- $a_1$  = the coefficient of expansion of the valve material,
- $t_2$  = the temperature of the surrounding casing,
- $a_2$  = the coefficient of expansion of the casing,
- $l$  = the distance between valve seats at normal temperature  $t_0$ .

Then 
$$\Delta l = l [a_1 (t_1 - t_0) - a_2 (t_2 - t_0)] \dots \dots \dots (12)$$

Substituting this value in equation (11), the pressure difference  $(p_a - p_i)$  will be found at which the valve will commence to be tight. At all greater pressure differences the valve will be perfectly tight.

For example, a valve is taken in which  $l = 30$  mm,  $R = 125$  mm,  $\rho = 104$  mm,  $d = 3$  mm,  $p_a = 12$  at, and  $p_i = 0$  at.

- Assume also that  $t_0 = 15^\circ$
- $t_1 = 300^\circ$
- $a_1 = 0.000012$
- $a_2 = 0.000011$ .

The following table gives the relative expansions  $\Delta l$  of this valve for certain temperature differences  $(t_1 - t_2)$ , calculated according to equation 12. In this table are also found the stresses  $K_b$  and the pressure differences  $(p_a - p_i)$  necessary for tightness calculated by means of equation 11.

$t_1 - t_2 =$	$0^\circ$	$50^\circ$	$100^\circ$	$150^\circ$	$200^\circ$
$\Delta l =$ in mm	0.009	0.0255	0.042	0.0585	0.075
$p_a - p_i =$ in at abs.	1.35	3.8	6.3	8.75	11.25
$K_b =$	230	645	1070	1490	1920

From these figures it will be seen that many prevalent valve constructions are far from being steam tight. The excessive height of many valves, neglecting other constructional errors, makes steam tightness absolutely impossible. Even in a valve only 30 mm high, with a temperature difference between valve and seat of  $200^\circ$  C., a steam pressure of 11.25 kg/sqcm is necessary in order to obtain steam tightness; i. e. at all lower pressures there will be leakage.

**Calculations** for a Resilient Valve of 160 mm mean diameter, for a condensing engine working with steam of 9 at. abs. (Fig. 5).

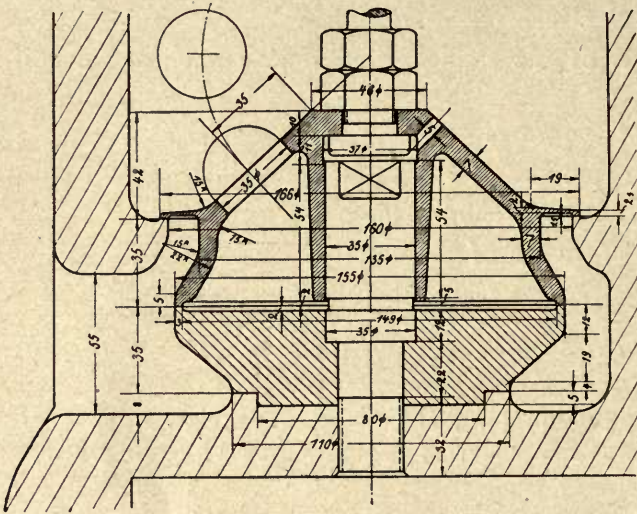


Fig. 5.

In Fig. 5,  $R_m = 81.5$  mm       $R_i = 80$  mm       $\varrho = 67.5$  mm  
 $r_m = 76$  mm       $r_a = 77.5$  mm       $\delta = 17$  mm.

The steam pressure on the valve stem is  $\frac{\delta^2 \pi}{4} \cdot (p_a - 1) = 18$  kg.

$W_1$ , according to equation (4) above, is  
 221 kg, for  $R_m$  and  $r_m$   
 195.5 kg, for  $R_i$  and  $r_a$ .

$W_2 = 0$  in case 2. The spring pressure  $F$  is then calculated from equation (5),

$$F = \frac{\delta^2 \pi}{4} \cdot (p_a - 1) + W_1 - (p_a - p_i) (R_i^2 \pi - r_a^2 \cdot \pi)$$

$$= 18 + 195.5 - 107 = 165.5 \text{ kg.}$$

With this spring pressure in case (1)

$$W_2 = P + (p_a - p_i) (R_m^2 \pi - r_m^2 \pi) - W_1$$

$$= 88.5 + 245 - 221 = 112.5 \text{ kg.}$$

The thickness  $d$  of the resilient ring is calculated for the case in which the valve is opened at the greatest pressure difference  $p_a - p_i$ , the valve and seat being assumed to have the same temperature.

Again taking a radial element  $d\varphi$  of the valve (Fig. 4), then

$$M_b = (R - \varrho) \frac{R + \varrho}{2} d\varphi (p_a - p_i) \frac{R - \varrho}{2} = \frac{1}{6} \varrho \cdot d\varphi \cdot d^2 \cdot K_b.$$

and

$$K_b = \frac{3}{2} \frac{(R + \varrho)(R - \varrho)^2}{\varrho d^2} \cdot (p_a - p_i).$$

The following two conditions are assumed for the calculations of  $W_1$  and  $W_2$ :

1. The actual closure occurs at the mean circumference in both the top and bottom seats (Radii  $R_m$  and  $r_m$ ).
2. In the most unfavorable case closure occurs at the inner edge of the upper seat ( $R_i$ ) and the outer edge of the lower seat ( $r_a$ ).

In the latter case  $W_2$  on the lower valve seat is to be zero.

If  $d = 2$  mm, then the bending stress at the radius  $R_m$  is  $K_b = 1460$  kg/sqcm. Such a high stress can only occur when the valve is opened against the full pressure difference.

If the difference in seat diameters is made less than is required by the above theory, then the lower valve face will lift off its seat and leakage will result. It is therefore always advisable to make a second calculation with the object of finding  $W_2$  under assumptions similar to case 2 (See above). For this worst case the numerical value of  $W_2$  should be positive.

The valve seats should always be made flat since they can then accommodate unequal radial expansion and give the maximum opening for the valve lift. The latter is always small in una-flow engines on account of the early cut-offs and the fact that the permissible lead is very small.

Experience shows that the upper seat wears more than the lower, especially if the seats are narrow. The upper seat should therefore be made wider and the edge of the resilient ring reinforced by a rim or bead. The resilient ring should not be made too weak.

The piston of a una-flow engine is placed between live steam space and exhaust. *Live steam space, inlet valve, piston and exhaust are in series*, while in the ordinary counterflow engine the piston is in parallel with the inlet and exhaust valves. This series arrangement is one of the important features of una-flow engines. The leakage of the steam valve of a counterflow engine is partly balanced by the leakage of the exhaust valve so that only the difference of these leakages affects the cylinder; the leakage of the inlet valve of the una-flow engine on the other hand has no such compensating means since there is no exhaust valve. In addition to this, the counterflow exhaust valve usually remains open during the greater part of the return stroke so that the leakage of the inlet valve only affects a short part of the latter. In the una-flow engine, however, the leakage of the steam valve continues during almost the whole compression stroke, and this has to be taken into account by properly proportioning the clearance volume, in order that the compression may not exceed the initial pressure and the engine begin to be noisy. The fact that leakage of the inlet valves of una-flow engines makes itself noticeable, especially with small clearances, must be considered an advantage of this type of engine, the effect of which, however, may sometimes become embarrassing. Counterflow engines show no such indication, so that great losses sometimes pass unnoticed. The above mentioned series arrangement together with the short duration of the exhaust tends to considerably reduce the losses due to leakage. These, however, may still be large if precautions are not adopted in the shape of resilient or single-beat valves.

A resilient valve may also be made of cast iron (Figs. 6 and 7). The author has designed several such valves for use on British una-flow engines, which have given complete satisfaction.

The necessary amount of resiliency may also be obtained by properly shaping the lower seat on which the valve rests. (Fig. 8.) Here the seat at the top of the saucer is formed with a resilient ring whose undercut should be such that the steam pressure acting upon it, in combination with the valve spring and the steam pressure on the valve stem give the same reactions on both seats. This design

offers the advantage that the valve can be made of cast iron in the ordinary way and only the relatively simple saucer need be made of steel.

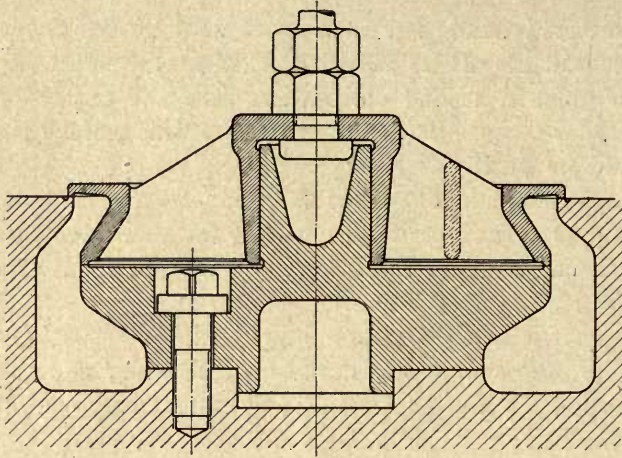


Fig. 6.

der, the resulting pressure on the small annular ring outside the lower valve seat tends to press the seat plate with increasing force against the valve face. The diameter of this seat plate must be proportioned so that the upward steam pressure combines with the spring force, the steam pressure upon the valve stem and the steam pressure upon the unbalanced area of the valve so as to produce equal bearing reactions on both seats. This last design has the least merit, since the seat plate rings will never be absolutely steam tight, and the clearance volume is larger than that required by the forms of valve previously described. Further the springs necessitated in this case as also those of Fig. 9 will very soon weaken at high steam temperatures.

All of the above constructions are based upon the previous theory which requires a certain difference in diameter of the two valve seats.

### Single-Beat Valves.

If one has studied the valve question in all its phases and has become acquainted with all of the difficulties of manufacture and operation, then the final result must be considered unsatisfactory. The following points should be noted.

1. If a double-beat valve is completely or partly balanced, it completely or partly violates the principles embodied in the single-beat valve, according to which the closing pressure is proportional to the area covered and to the pressure difference. This violation explains most of the difficulties usually met with.

2. If the double-beat valve is left unbalanced by such an amount as is required by the resilient valve theory, then, if it were possible to provide sufficient lift, a single-beat valve of an area equal to the unbalanced area of the double-beat valve

The same principle is expressed in Fig. 9, in which the resilient ring is a separate piece acting in the same way as in the previous valves.

Finally, the valve shown in Fig. 10 obtains the necessary resiliency by means of a separate seat plate fitted with snap rings and pushed upwards by small springs. Holes provided in the seat plate allow the live steam pressure to act underneath it; and as soon as a pressure difference exists between valve chest and cylinder,

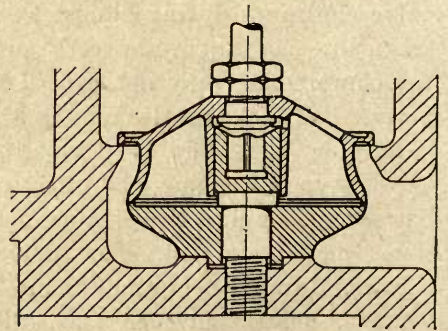


Fig. 7.

would provide sufficient opening for the steam flow. Such a single-beat valve with the corresponding valve gear is described in the last chapter.

If no difficulties have been encountered with the resilient valves in respect to governing, the same must hold true of the single-beat valve of equal area. This forms an accord with the internal combustion engine in which the single-beat valve has been persistently adhered to for very good reasons. The high lift single-beat valve has a diameter which is less than half of the diameter of a double-beat valve of equal area of flow. Such a valve may be ground in cold. It allows of a considerable reduction of the clearance volume and harmful surfaces,

and insures perfect tightness at all temperatures and pressures even with extreme variations of the same. It may therefore be claimed that the single-beat valve

with a high lift is the only means by which complete safety against leakage can be provided.

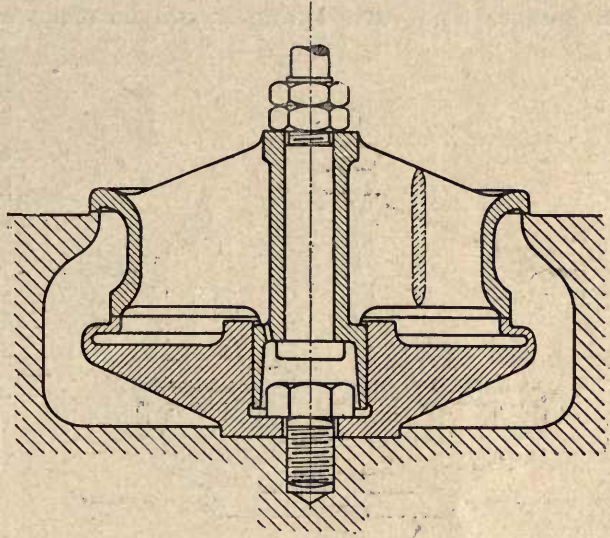


Fig. 8.

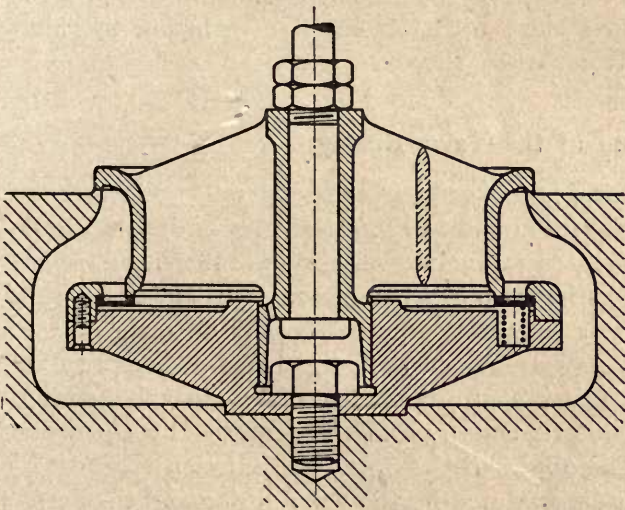


Fig. 9.

### Valve Bonnets.

A valve bonnet of Lentz design is shown in Fig. 11. The connection between stem and valve is made by means of the valve stem head and two nuts, one of them being a lock nut. The stem screws into the cast iron roller head and is secured by a lock nut. Fine thread is advisable in both places. The valve stem guide is formed by a cast iron

bushing which should be made heavy to facilitate manufacture, and in case of superheated steam should be equipped with a separate force feed lubricating connection. It is wrong to supply oil to the steam chest. The flow of steam through the cast iron valve, on account of the slight unavoidable obliquity of the ribs, produces a turning moment which must be resisted by properly fitting

the cam lever into the slot of the roller head, in order to insure proper relation of roller and cam. The intentional slanting of the ribs with a view to producing continuous rotation of the valve to insure better tightness has shown no advantage. The valve spring should be made adjustable in order to overcome

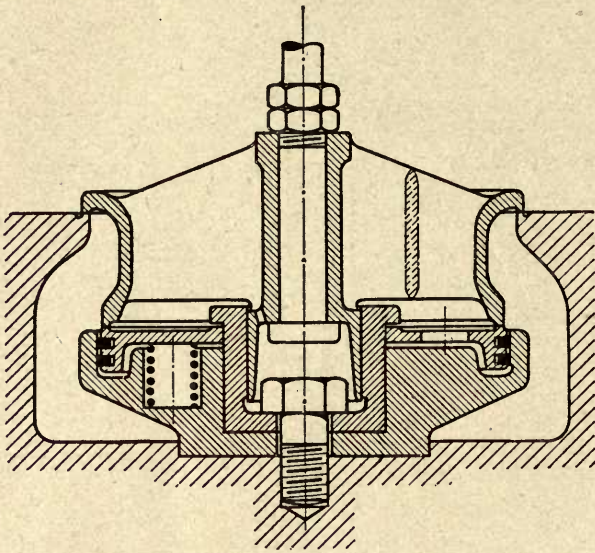


Fig. 10.

the increased friction during the first period of operation. Large bonnets should be provided with a false cover or be otherwise insulated from the live steam space, so that radiation may be reduced, and the transfer of heat to the valve gear parts minimized. Valve roller, pins and cam lever should be made of steel, hardened and ground. It is better to place the valve roller on the roller head than on the cam lever.

The radial difference between the upper and lower lands of the cam corresponds to the valve lift. The lifting curve should rise tangentially from the lower land and join the upper land by means of another curve or fillet which runs tangentially into it. Sometimes a straight piece is inserted between the two curves, with the object of reducing the high acceleration at the point where the curvature changes.

### Calculation of the Valve Spring.

The purpose of the valve spring is to keep the cam and roller positively in contact during the time the valve is lifted and to keep the valve on its seat while it is closed. The parts to be accelerated are valve, valve stem, roller head, roller, roller pin, and valve spring. The spring also has to overcome the steam pressure upon the cross-section of the valve stem. It is always advisable to make sure of the amount and direction of this pressure, since there are cases (exhaust valves of high pressure cylinders) where this pressure tends to relieve the valve spring. The maximum accelerations and retardations are partly produced by the valve gear and partly by the spring. The object of the present calculation is to determine the maximum acceleration to be produced by the valve spring and the necessary dimensions of the latter. The usual method consists in plotting the valve lift on a time basis and differentiating twice to obtain a curve of accelerations, from which the maximum acceleration may be taken and the spring calculated. This method is not very exact. The following method, based on the same principle, is more accurate.

The calculation will be made for the largest cut-off and a speed of 100 r. p. m., the angularity of the eccentric rod being neglected. Then the angular velocity



$\omega = 10.5$ , and the time for  $1^\circ$  of crank angle  $t = \frac{1}{600}$  sec. For any other speed  $n$  the valve velocity  $v$  must be multiplied by  $\frac{n}{100}$  and the acceleration by  $\left(\frac{n}{100}\right)^2$ .

Time or crank angle is taken as the abscissa for all calculations. The investigation will extend only to the point at which the cam lever reverses, since the

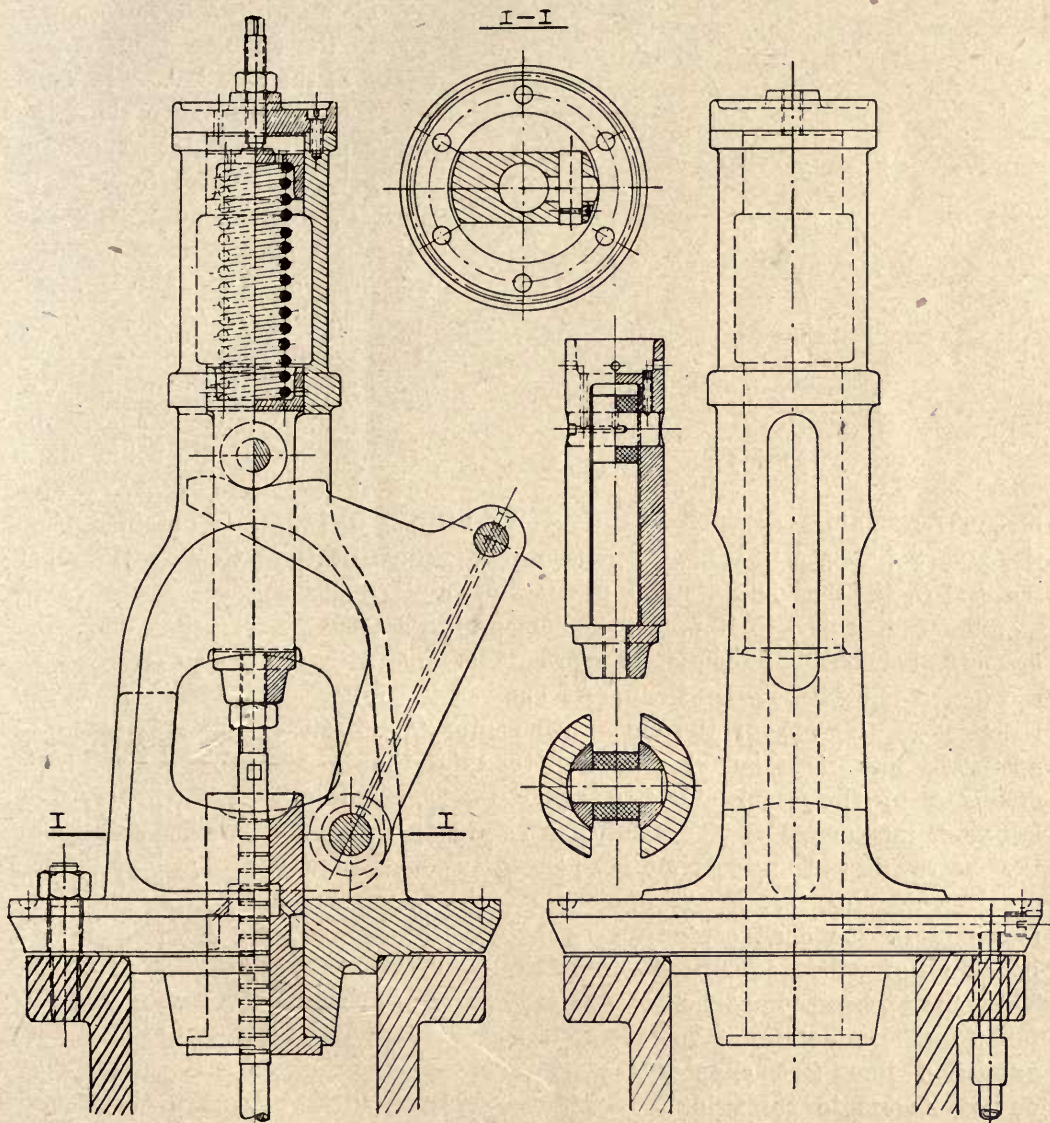


Fig. 11.

subsequent closure of the valve is an exact repetition of the phases during lifting. The necessary dimensions of the valve gear parts are assumed to be known or are determined according to Figs. 12, 13 and 14. From Figs. 13 and 14 the travel of the cam lever ( $a = KK'$ ) can be found corresponding to the crank angle  $\alpha$ .

This corresponds to the part  $MM'$  of the valve lift curve (equidistant from the cam profile through the center of the cam roller) and the valve lift  $h$ . The cam

lever therefore changes  $a$  into  $h$ . The line  $J-K$  in Figs. 12 and 13 corresponds to the  $x$ -axis in Fig. 14. The distance  $a = KK'$  corresponds to the angular displacement  $\beta$  of the cam lever. Imagine the roller to move along the cam (the latter supposed held stationary) from  $M$  to  $M'$ , corresponding to the angle  $\beta$ .  $ML$  is the center line of the valve stem. Drawing  $M'L'$  tangentially to an arc struck from center  $N$  with radius  $NL$ , the base circle  $MM'$  will be intersected at a point whose distance from  $M' = h =$  valve

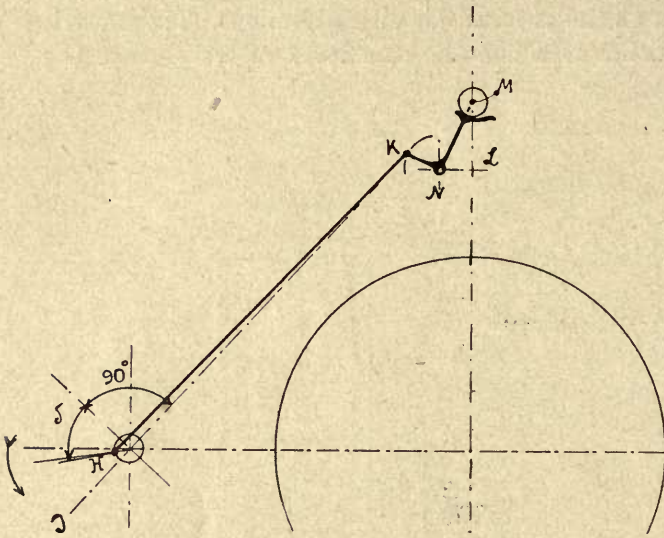


Fig. 12.

lift, corresponding to  $a$  and  $\beta$ . The valve lift curve  $MM'Q$  is obtained from the cam profile by increasing or decreasing the radius of the latter by the roller radius.  $O_1M$  is usually from 3 to 10 mm, and  $O_2M' =$  roller radius + 3 to 10 mm. The cam profile as well as the valve lift curve consist of two circular arcs with a common tangent between them. As long as the roller remains on the arc of the cam with center  $O_1$ , it is advisable for the sake of accuracy to take the increments of the crank angle  $a$  equal to  $2^\circ$ , while, later on, increments of  $5^\circ$  are sufficient. Fig. 15 shows the valve lifts thus determined plotted against the crank angle  $a$ .  $h_{\max}$  corresponds to the dead center position of the eccentric. This curve is also important for the determination of the admission line (see chapter on losses due to throttling). Instead of now differentiating this valve lift curve to find the valve velocities, the latter may be determined in a more exact manner from the instantaneous angular velocity and the corresponding lever

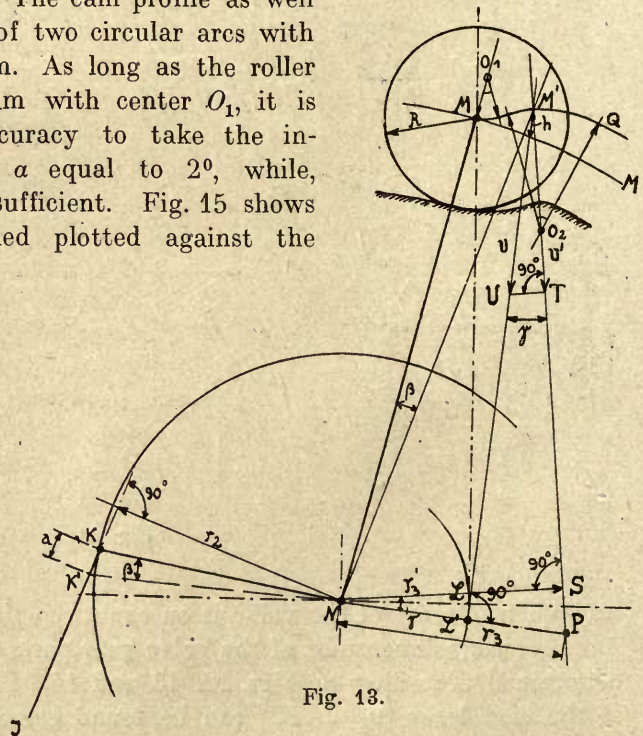


Fig. 13.

arms. The velocity of the eccentric rod  $HK$  in Fig. 12 is found from Fig. 14 to be

$$v_1 = v \frac{r_1}{r} = \frac{2 \cdot \pi \cdot r \cdot n}{60} \cdot \frac{r_1}{r} = \omega \cdot r_1.$$

The angular velocity of the cam lever is  $\omega_1 = \frac{\omega \cdot r_1}{r_2}$  (Fig. 13). The "roller contact line"  $M'O_2P$  always intersects the roller center and either of the centers  $O_1$  or  $O_2$ , or is at right angles to the straight middle piece of the valve lift curve. The velocity along the roller contact line is  $v' = \omega_1 \cdot r_3'$ . For the velocity along the relative valve stem axis  $M'L'$  (valve velocity  $v$ ),  $r_3$  has to be considered instead of  $r_3'$ , since the right-angled triangles  $NSP$  and  $M'TU$  are similar, and  $v : v' = r_3 : r_3'$ . Therefore the valve velocity  $v = \omega_1 \cdot r_3 = \omega \cdot \frac{r_1}{r_2} \cdot r_3$ . The distances  $r_1$ ,  $r_2$  and  $r_3$  are to be measured in meters. The roller contact line  $M'O_2P$  coincides with  $MN$  for the point of valve opening and therefore  $r_3 = 0$ . The same occurs when the roller reaches the upper land and  $M'$  falls on  $Q$ , in which case also  $r_3 = 0$ . The valve velocities thus determined are plotted in Fig. 15 on a crank angle basis, giving the curve  $v$ , which indicates a rapid increase of the velocity up

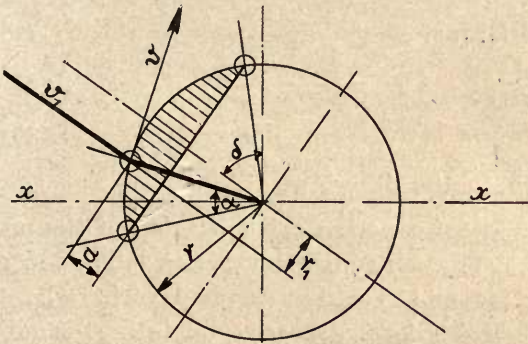


Fig. 14.

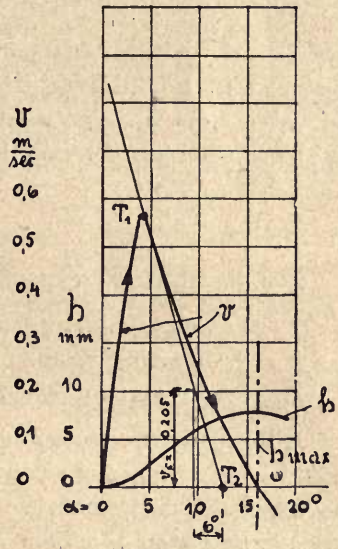


Fig. 15.

to the point  $T_1$ , corresponding to the point at which the lifting curve and straight portions merge, after which it decreases until it reaches zero for the dead center position of the eccentric, or for the point at which the upper curve and upper land run together. The velocity  $v = 0$  corresponds to the dead center position of the eccentric after which the whole procedure is repeated with the signs reversed. In case the roller reaches the upper land or runs a certain distance on it, a corresponding part of the velocity curve coincides with the  $x$ -axis.

The maximum valve acceleration  $p = \frac{dv}{dt}$  corresponds to the steepest tangent  $T_1T_2$  of the velocity curve. Receding from point  $T_2$  a distance equal to  $6^\circ$  crank angle or  $1/100$  sec, an ordinate at this point will represent the change of velocity in  $1/100$  sec. In this case the latter amounts to  $v_x = 0.205$  m/sec. The accelera-

tion is consequently  $p = \frac{0.205}{1/100} = 20.5$  m/sec. If the scale of velocity is chosen so that 100 mm = 1 m/sec, then the ordinates in mm give directly the accelerations in m/sec. The accelerating force during the period of increasing velocity is exerted by the eccentric through the cams, and for decreasing velocity the retarding force must be produced by the valve spring. The opposite holds true for the closing period of the valve.

The force to be exerted by the valve spring depends upon:

1. The maximum acceleration  $p_{\max}$  to be produced by the spring.
2. The weight  $G$  of the valve and the parts connected to the same.
3. The friction of the valve stem, valve and roller head.
4. The steam pressure upon the valve stem area.

The weight  $G$  is generally assumed to be balanced by the friction and therefore neglected.

The accelerating force  $P = \frac{G}{9.81} \cdot p_{\max}$ . An additional 10 to 20% are necessary to take care of inaccuracies in the construction of the valve gear and the increased friction during the first period of operation. The steam pressure on the valve stem area may either relieve or oppose the spring and must in every case be considered. Torsional stress of the spring material  $k_a =$  about 3500 kg/sqcm.

### Pistons.

Pistons may be classified as:

1. Self-supporting pistons.
2. Floating pistons.
3. A form intermediate between the other two.

All questions concerning the design, construction and operation of the piston should receive thorough consideration. The self-supporting piston is undoubtedly the most difficult, and the floating piston the easiest to deal with. The self-supporting piston together with its cylinder form a bearing. The first condition for satisfactory operation is therefore sufficient difference in the properties of the materials of which the two parts are made. For instance, a steel shaft runs quite satisfactorily in a babbitt, phosphor bronze, brass or cast iron bearing. All these combinations present sufficient difference in the properties of the materials employed. An exception exists in the combination of hardened steel on hardened steel which may frequently be found in valve gear joints. Babbitt on babbitt, bronze on bronze, or mild steel on mild steel never work together satisfactorily. Cast iron pistons, however, can be made to work well in cast iron cylinders, as is shown by the una-flow engines built by Sulzer Bros. Cast iron is a collective designation which includes materials of very heterogeneous composition. Sulzer Bros. after extensive experiments have found the proper mixtures for the cylinder and piston, which possess sufficient *difference in properties to work together safely and satisfactorily*. If a designer lacks sufficient faith in his foundry he will do well to equip his piston with a babbitt or bronze mounting in order to provide materials with

sufficient difference in properties. A cast steel piston should always be equipped with such a bearing surface. There are still, however, concerns who try to make piston and cylinder from the same mixture, and in addition to this cardinal error commit others of equal consequence which result in certain failure. There are also materials which do not work well together despite sufficient difference in their properties, such as for instance, cast steel on cast iron. Even with a bronze mounting the difference in expansion between these two materials must be taken into consideration.

A journal and bearing must ordinarily have sufficient clearance to allow room for the oil film. This condition applies all the more to piston and cylinder since the dimensions are larger and the temperature difference is greater. A clearance of 3,5 to 4 thousandths of the diameter between piston and cylinder bore have been found satisfactory. Machining the piston by first turning it to the exact cylinder diameter and afterwards turning it off eccentrically so as to produce a bearing surface for about 90 to 120° has not proved satisfactory for superheated steam. This method gives enough clearance at the top but on account of the higher temperature of the piston and its greater expansion, the weight concentrates at the edges of the bearing surface and the piston is likely to seize. A proper way of finishing the cylinder is to bore it barrel-shaped, or machine it while heating the ends, for instance by passing steam through the jackets and cooling the center by blowing air through the exhaust belt. The heads of a una-flow piston expand more than the center by reason of their higher temperature, and should therefore be of smaller diameter than the center. They should be out of contact with the cylinder and only act as plungers. The part of the piston forming the bearing surface should be rounded off liberally at its ends to prevent it from scraping the oil off the cylinder wall. Briefly, the endeavor must be to produce a piston and cylinder with exact cylindrical surfaces and sufficient clearance, and to maintain this condition at high temperatures. If this can be accomplished for the long una-flow piston with its large bearing surface and temperature difference, the most difficult part of the problem is solved.

The case of the floating piston which is carried by the piston rod is much simpler. A radial clearance of 2 to 3 mm, according to the size of the cylinders, may be used, so that no consideration of bearing action is necessary. Only the piston rings project beyond the piston surface and are in contact with the cylinder wall. The tail rod can either have a stationary bearing behind the stuffing box or be carried on a crosshead. The great length of the piston rod between the bearings caused by the long piston, makes a light cast steel construction and a rod of large diameter a necessity. From a thermal point of view the floating piston is to be preferred, since only the piston rings transmit heat from the hot to the cold portions of the cylinder, while in the case of the self-supporting piston the large bearing surface also takes part in this action. When using a stationary bearing for the tail rod behind the stuffing box there will be a rise and fall of the piston at every stroke, which must be considered. If the cast steel used is very soft, then the cast iron rings are liable to seize.

The long and heavy piston together with the long span of the rod usually bring about a condition which is a mean between the floating and self-supporting

constructions. Part of the weight is then carried by the cylinder wall and part by the piston rod. The wear of the cylinder tends to alter the weight distribution in such a way as to increase the part carried by the piston rod and thus relieves the piston and cylinder bearing surfaces. The piston rod also resists possible forces acting on the outside of the piston. If for instance, the piston rests in the cylinder and by reason of leaky rings the steam obtains access to the clearance space above the piston, then a heavy downward load will result. Floating pistons offer greater safety against this possibility, this safety being imparted by the piston rod. This applies especially to vertical engines where the piston, if not guided by a tail rod, is in a condition of unstable equilibrium and is liable to slap. This may even be occasioned by the piston overrunning the inlet ports, which should be fundamentally avoided. Such overrunning can only be permitted in the case of floating pistons, although even then the possibility of vibration should be reckoned with. The greater number of mistakes which give rise to lateral forces are incurred in the arrangement and construction of the piston rings, which latter should protect the piston surface against such forces. For this reason they should be placed as far as possible towards the ends of the piston, in order to leave as little area as possible for the formation of lateral forces. Even if this is done there still remains some possibility of an unbalanced load, especially with the large surface of a una-flow piston. If, for instance, the rings of a horizontal engine are not secured against creeping, their center of gravity, being located eccentrically opposite the joints, will move to the lowest possible position and all the joints will fall in line at the top. The steam leaking through them will then undoubtedly exert a heavy pressure upon the large surface, thus forcing the piston downwards and causing rapid wear. This cannot happen with a floating piston since the pressures will equalize in the annular space and temporary lateral forces will be resisted by the piston rod. The ring joints of floating pistons and of pistons having the rings on the plunger heads should therefore be equally spaced over the circumference; for instance, where three rings are used at each end, the joints should be at  $120^\circ$ . In self-supporting pistons without plunger heads, the ring joints should be kept within the bearing area; thus for three rings one joint may be arranged in the center and one each at  $30^\circ$  to the right and left. The bearing surface then protects the ring joints against the steam. With such an arrangement complete tightness may be attained if the workmanship is good and the rings are sufficient in number. In floating pistons the action of the rings is similar to a labyrinth packing which always passes a certain amount of steam, since the ring joints can never be made absolutely tight. The pressure ratio in case of una-flow engines always being above the critical value, the weight of steam flowing past the ring joints may be calculated by means of the formula

$$G = f \cdot \sqrt{\frac{p_1}{v_1} \cdot \frac{g}{z + 1,5}} \text{ kg/sec,}$$

in which  $f$  denotes the free area of the joint,  $z$  the number of joints in series,  $p_1$  and  $v_1$  the absolute pressure and the specific volume of the steam inside the cylinder. In Fig. 16 are illustrated five different types of ring joint fastenings which can only partly render the joints tight, but perform the important addi-

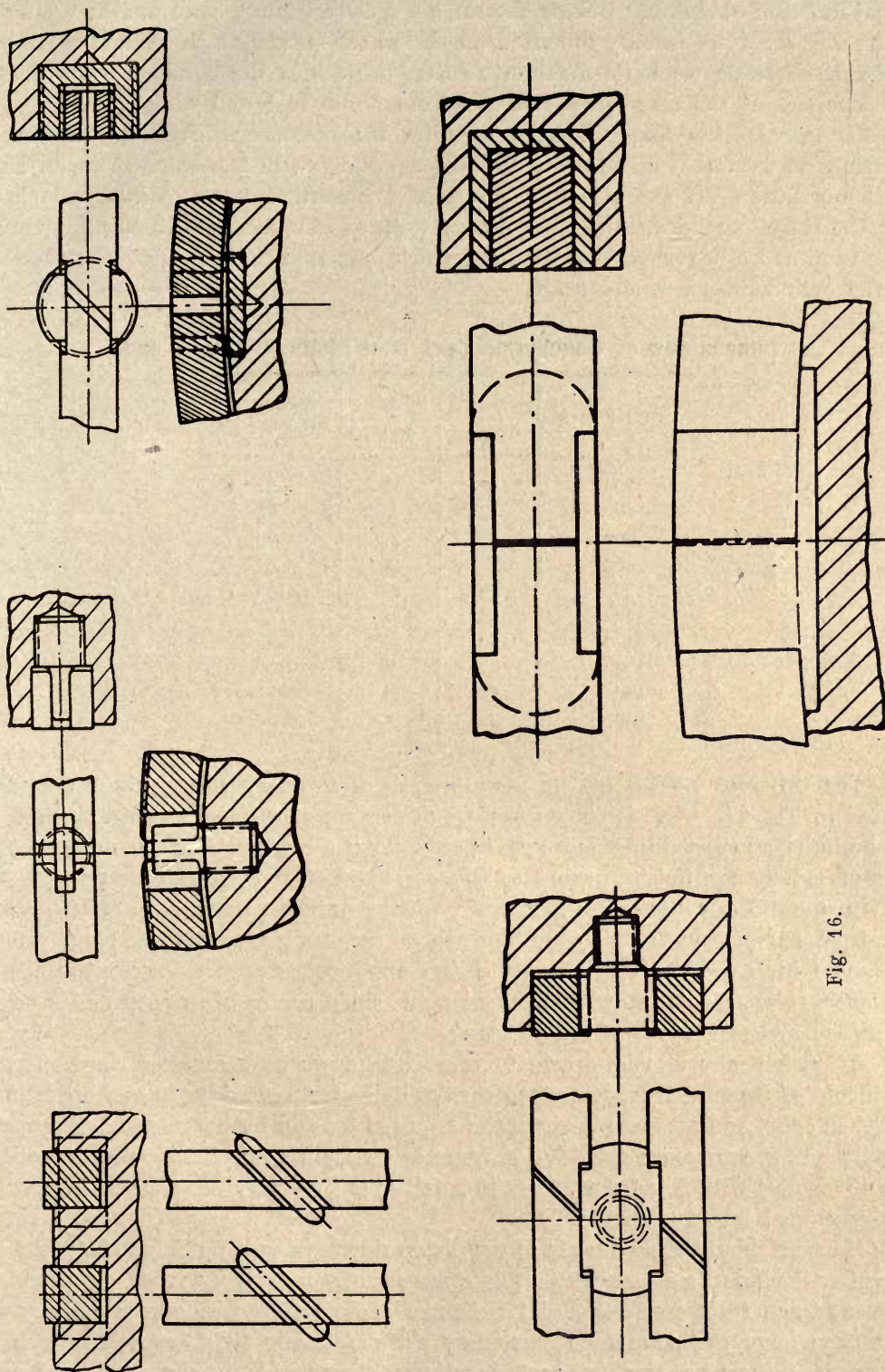


Fig. 16.

tional function of securely locking the rings against creeping. In a una-flow piston where the rings are usually mounted on the piston heads which expand considerably, the locking elements must in no case project to the cylinder wall.

The slot at the ring joints must be from 2 mm to 5 mm wide, according to the diameter of the rings, in order to allow for expansion. Friction will cause the rings to assume a higher temperature, especially with superheated steam and poor lubrication. If the clearance provided is insufficient, the joints will close and the rings expand against the cylinder wall, so that increased heating, greater expansion and a heavier pressure result, which may lead to a complete destruction of the cylinder surface and rings.

### Dimensions of Concentric Cast Iron Piston Rings in mm.

Cylinder Bore	Piston Ring		Length of piece cut out
	Thickness	Width	
300	12	12	24
400	15	15	35
600	20	20	60
800	22	22	84
1000	25	25	108
1200	28	28	132
1400	30	30	155
1600	32	32	180
1800	34	34	205
2000	36	36	230

The different phases in the manufacture of ordinary piston rings are presented in Fig. 17. First is shown the rough casting of sufficient width to hold it in the lathe, rough turning and cutting off follow; a piece is then cut out and the ring closed up for finish turning to the correct diameter. It is not possible to obtain a uniformly distributed pressure with concentric rings, and only a very rough approximation to this condition can be reached with excentric rings whose thickness increases from the joint to the opposite side. The concentric type, however, is preferable in order to avoid a one-sided center of gravity and a large clearance in the groove behind the ring.

Attention may also be drawn to what are known as hammered rings. These are made of Swedish iron, turned to correct diameter and width in one operation, are then split, and afterwards given the required tension by hammering. Approximately uniform pressure distribution, greater strength and reliability in operation are obtainable with this form. Even in small sizes they may be sprung sufficiently to be slipped into the piston.

Mention should also be made of the piston rings designed by Schmeck (Fig. 18), which are made in sections whose joints are secured by spring-loaded plugs which prevent them from creeping and force them against the cylinder wall. Rings of this type have the advantage that they are practically tight, especially at the joints, that their bearing pressure is uniform, they can be easily assembled and disassembled, and adapt themselves to warped cylinders. The cast iron plugs



and ring sections are finished in such a way as to fit the cylinder bore. This type of ring is much used by the Hannoversche Maschinenfabrik vorm. Egestorff and is reported to have given complete satisfaction.

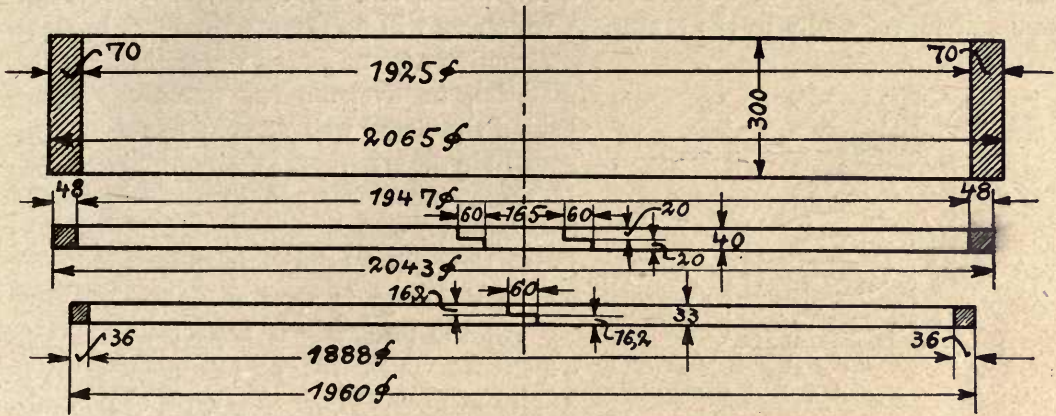


Fig. 17.

It is advisable not to permit the outer ring to overrun the cylinder bore. Such overrunning exposes part of the ring surface to the steam pressure, thus causing the ring to collapse and destroying its function of tightness for at least a certain distance near the dead center. An ordinary cast iron ring, especially if the de-

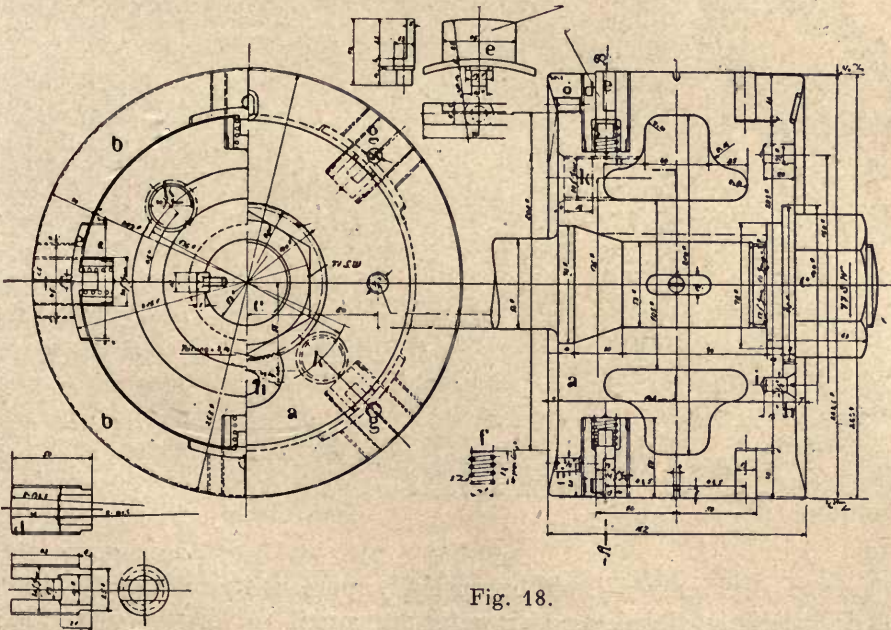


Fig. 18.

flections are large, will not withstand the stresses produced thereby for any length of time. The clearance behind the rings should be made as small as possible, so as to reduce the deflection and leave as little space as possible for the accumula-

tion of steam which would press the ring against the cylinder wall and cause considerable wear both on the ring and cylinder, especially in the middle of the latter. With superheat and dirt in the steam a ring may under these conditions lose as much as 5 to 10 mm in thickness in a few weeks, and the cylinder bore several millimeters, especially in the center. A wide ring will be the most subject to this destructive action. Small width, high grade material, no overrunning, small clearance behind the rings, well secured joints, and a good fit in the grooves are therefore advisable. If the cylinder is made of a fairly hard, close-grained cast iron, then no ridges will form, thus eliminating any reason for allowing the rings to overrun.

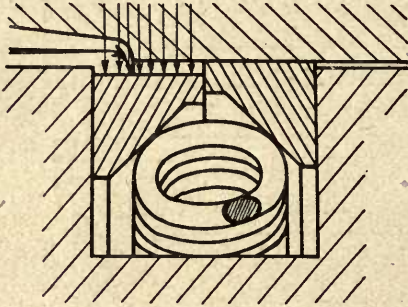


Fig. 19.

All the foregoing is supported by the experience which the author gained with a piston packing of the type shown in Fig. 19. Both rings overran the cylinder bore. The rings, in collapsing, had to push the spring along their sloping surfaces, with the effect that both rings and spring went to pieces. Fig. 20 shows the pieces which the author found in the cavity of the piston. The spots where wear occurred on the springs are clearly visible in Fig. 20.

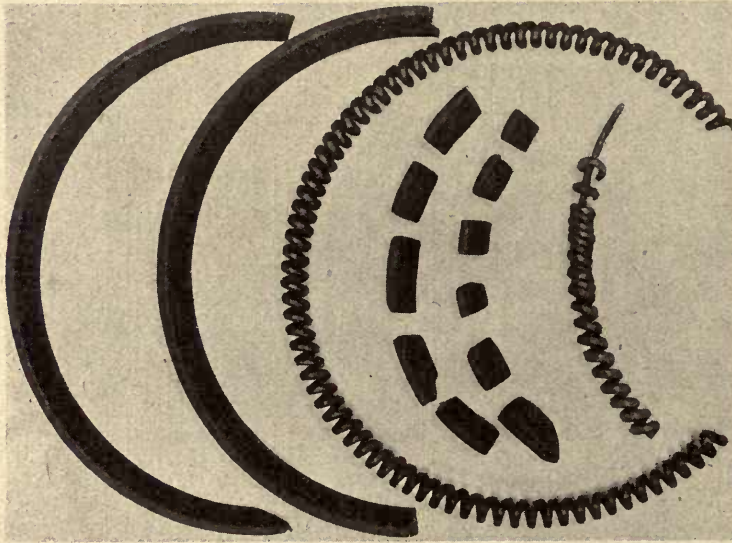


Fig. 20.

The number of rings used should vary according to the pressure range. The usual arrangement of the rings at the ends of a una-flow piston, with both sets active during the first part of the stroke, fulfills this requirement in the best possible manner.

A una-flow piston should always be made in two or three parts, held together by piston rod and nut. The castings in this case are simple, light

and without core plugs, which will be especially appreciated in the case of cast steel. It is advisable to test the piston with water pressure if the foundry cannot be relied upon. A cast steel piston of two-piece construction is shown in Fig. 5, page 77. Each half carries a bronze shoe fastened to it with copper rivets, covering an angle of  $120^\circ$ . The two halves, fitted with three rings each, have radial clearance over their whole circumference and are made as light as possible in order to reduce inertia.

The ring joints have a labyrinth effect. Fig. 40, page 157, shows an older piston of one-piece design having grooves fitted with Allan metal rings. The latter are made to project about 1 mm above the surface of the piston when new, and during the first period of operation part of this metal is transferred to and fills out the pores of the cylinder surface. Both these rings should be placed in the middle of the piston.

Una-flow pistons for locomotives are always made in three pieces, i. e., two heads carrying the piston rings, having clearance all around, and a center supporting piece. It was formerly customary to make the latter of hard steel, but Swedish iron is now used with better results. The heads which are made of cast or forged steel, expand considerably under the action of superheated steam. This expansion is transmitted to the center piece and must be considered in designing the latter. In order to reduce the weight of the reciprocating parts to a minimum,

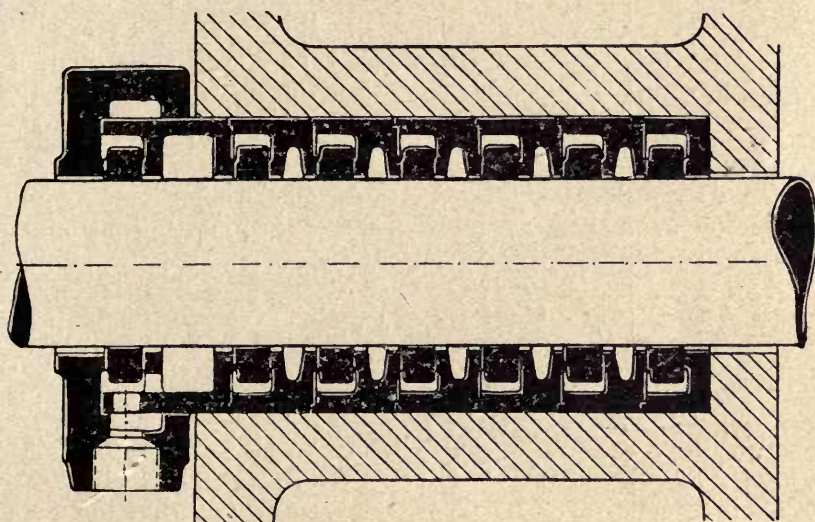
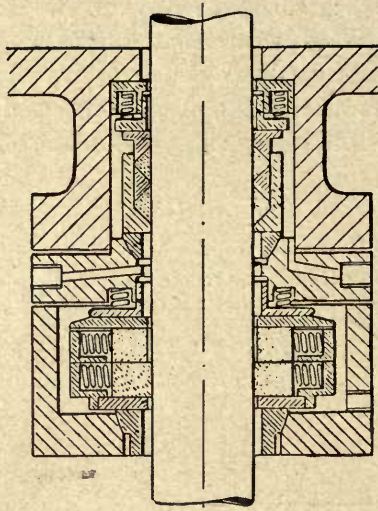


Fig. 21.

locomotive pistons are always made without tail rods and have given satisfaction except for minor troubles. These have been due to errors in the composition of the material and to disregard of the effect of the expansion of the heads upon the center supporting piece. The experience obtained with such pistons, as well as the favorable observations of Sulzer Bros., indicate that the problem may be solved with self-supporting pistons, provided the important requirement of a reliable lubrication system is satisfied. One oil feed on top, and one each in or below the horizontal plane on both sides of the cylinder, every feed being connected to a separate force feed pump, will give satisfactory results with the proper kind of oil. The pump plungers should be timed to deliver oil only during the periods when the corresponding orifices are covered by the piston. If the feeds are connected to the cylinder ends, carbonization of the oil is to be feared; and if the oil is fed to the center of the cylinder at the time of exhaust, it is likely to be blown through the ports. Both these conditions lead to a high oil consumption which is sometimes complained of in connection with una-flow engines. The time during

Type B Duplex packing for steam pressures above 6 at. and condensing service.



Type A Simplex packing, for steam pressures up to 6 at.

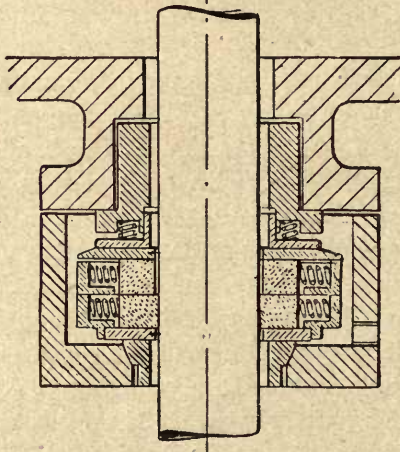


Fig. 22.

which the piston covers the oil feeds is longest when the latter are in the middle of the cylinder, so that even with pumps having a continuous feed there is a reasonable certainty of oil being carried between the rubbing surfaces. In order to avoid losses due to the exhaust, it is permissible to arrange the three feeds close to one side of the exhaust belt instead of in the center. In regard to lubrication also, the floating piston offers greater safety, since, if correctly constructed, the rubbing surface is limited to the rings. If, however, the steam obtains access to the spaces behind the rings, heavy friction and large oil consumption may result. With self-supporting pistons the same effect may be caused by lateral forces.

Everything considered, it may be stated that the self-supporting piston requires greater care in regard to design, choice of material, lubrication and operation, but has the advantage of not requiring a tail rod with its bearing or crosshead. The floating piston has greater reliability but is more complicated and increases the floor space required. Self-supporting pistons may however be made to operate satisfactorily.

### Piston Rod Packings.

Soft packing is used only in small and cheap engines, while metallic packing is the rule with steam of high pressure and superheat.

The Lentz packing shown in Fig. 21 consists of a plurality of one-piece cast iron rings, whose number varies according to the pressure to be carried. These

rings are fitted to the rod and work between the ground surfaces of a corresponding number of housings, thus producing a labyrinth effect. The individual housings form metal to metal joints and are pressed against the bottom of the packing space by means of the outside gland, sufficient clearance being provided to allow the cast iron rings to move laterally. The last chamber collects the water of condensation so that it may be drained away. With pure steam, absence of dust, and good lubrication (the oil being preferably forced into the packing under pressure), satisfactory results should be permanently obtainable. The one-piece rings may sometimes be found unhandy in assembling.

The American type of packing shown in Fig. 22 is better in this respect, since it may easily be assembled and disassembled and offers greater freedom in the design of adjacent parts. Each ring is made in four pieces, the two opposite segments with their babbitt lining being pressed against the piston rod by

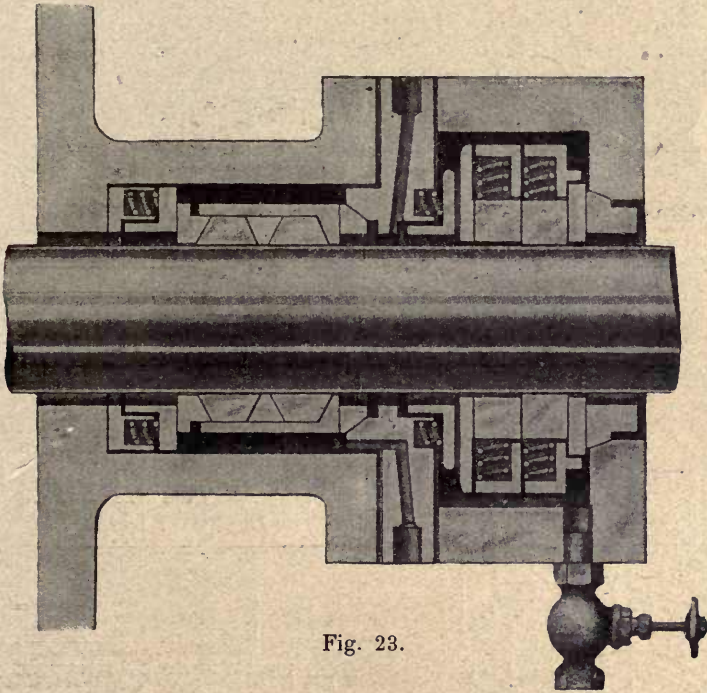


Fig. 23.

means of springs. The second ring of similar construction is set at  $90^\circ$  to the first one. The two remaining segments of each ring are forced by springs against the other segments. Both rings are properly fitted to the housing at their joints and relatively to each other. The whole packing system is held by means of axial springs against a spherical seat, thereby accommodating itself to inclined positions of the piston rod, while any lateral movement of the same is provided for by the sliding fit of the rings in their housings. This packing is occasionally stated to be unsatisfactory for vacuum, although this criticism may be unjust. The Duplex packing shown in Fig. 23 which is equipped with an additional set of conical babbitt rings, is equally satisfactory for both vacuum and high pressure. Different

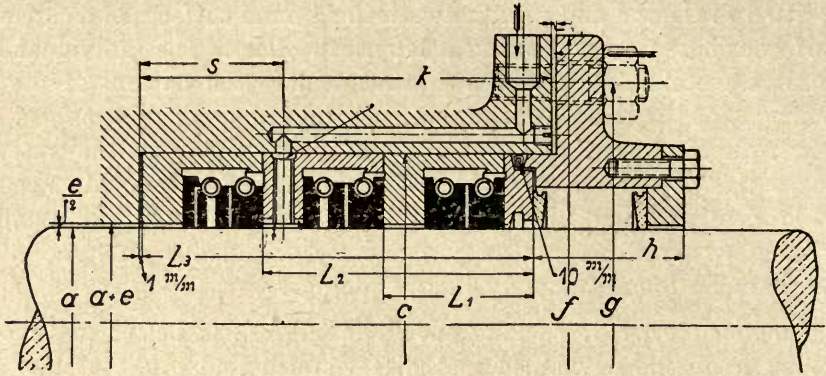


Fig. 24.

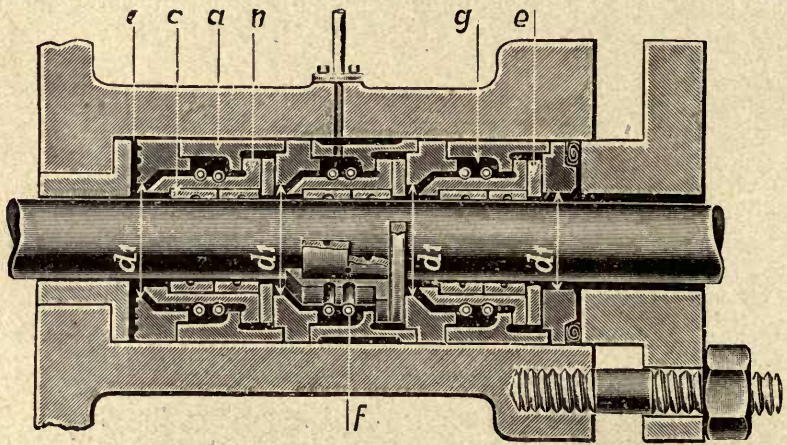


Fig. 25.

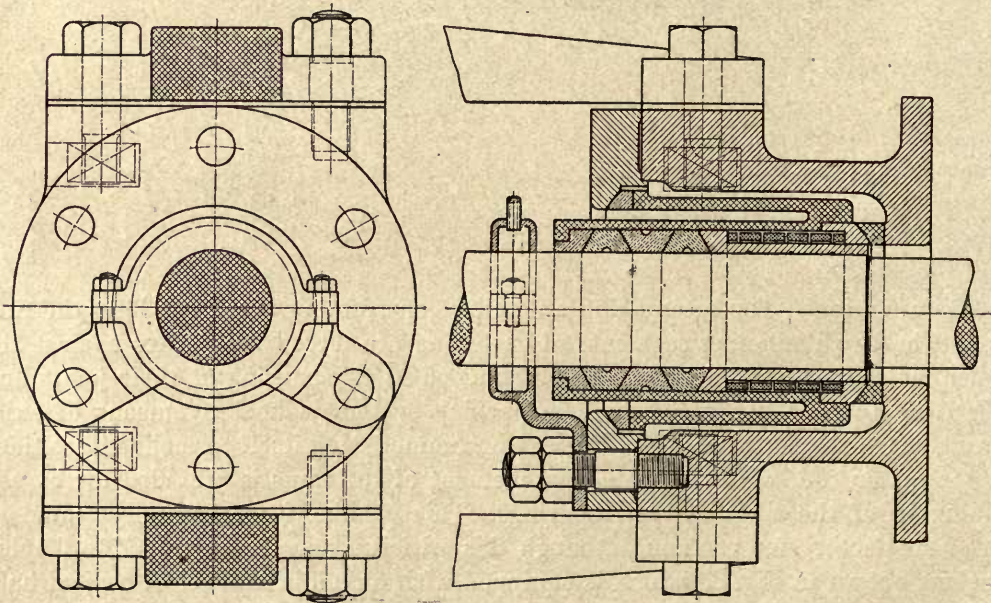


Fig. 26.

springs are supplied for various pressures. Good workmanship is claimed for this packing. Pure steam, regular and ample lubrication, as well as frequent use of the drain cocks, especially in running in, are essential for success.

Packings of a similar type of Simplex and Duplex construction are offered by the firm of Max Dreyer & Co., of Magdeburg.

The Proell packing (Fig. 24) is based on a similar principle. Each cast iron ring is cut into six parts which are held together by means of a coil spring, the joints of one ring being staggered in relation to those of the adjacent one. A pair of such rings is contained in each housing, which is easily removable by means of an internal lip. These housings come together on metal to metal joints and thus form chambers in which the rings have sufficient play to enable them to move laterally. The whole packing is held together and against the bottom of the packing space by the outside gland. The oil is either fed onto the piston rod or forced between the middle rings. This packing, however, does not accommodate itself to inclined positions of the piston rod. This packing is furnished in Simplex, Duplex or Triplex forms, according to the number of rings employed.

The Kranz packing (Fig. 25) made by the Elementenwerk Kranz, of Ludwigs-hafen, also employs cast iron rings in pairs, each cut into three parts, surrounded by sectional primary housings held together by coil springs. These primary housings are radially movable between the ground surfaces of the secondary housings, provision being also made for axial expansion of the former. Oil may be fed under pressure to the packing, although it is claimed that a drip feed to the rod is satisfactory. The use of three pairs of rings with a large number of cavities results in a thorough labyrinth effect. The water of condensation is caught by a further pair of rings on the outside, so that it may be drained away.

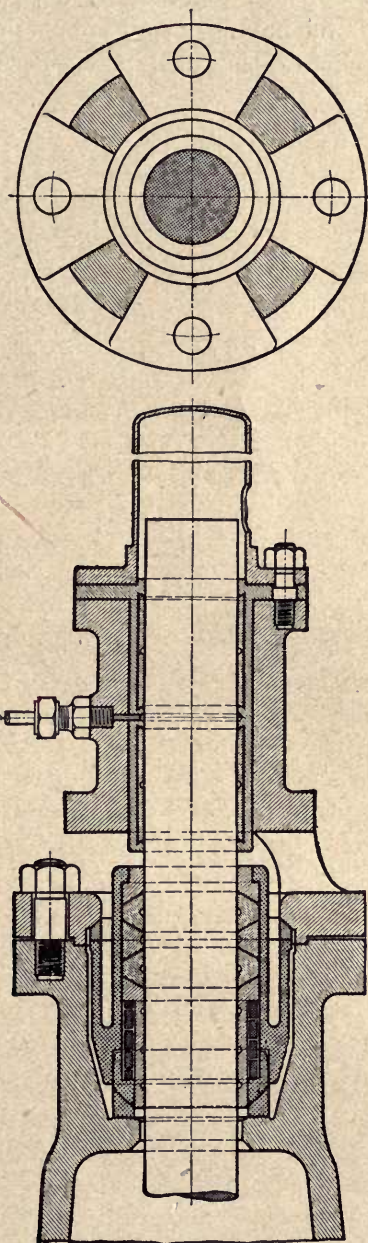


Fig. 27.

The packing designed by Wilh. Schmidt (Figs. 26 and 27) takes care of inclined positions of the piston rod in the best possible manner. The packing as a whole is inserted between two rings having spherical surfaces with a common center, these in turn being held between two flat surfaces so that both lateral and rotative movements are rendered possible. A deep recess insures further flexibility as well as a cooling effect. The segmental babbitt rings of conical section are held together by a powerful spring. A special fitting containing a felt ring and having an oil connection serves to lubricate the rod as well as to keep out dirt. This packing has been very successful on locomotives.



## 6. Losses due to Radiation and Convection.

It will be seen from a comparison of the una-flow with the ordinary compound counterflow engine that the former can have only small radiation and convection losses. The radiating surface of the counterflow engine with its two cylinders, receiver and accessories is two or three times as large as that of the una-flow engine, with correspondingly higher losses. The loss due to radiation of the una-flow cylinder is very small compared with the radiation losses of the steam pipe, for which reason the latter will be dealt with first. Assuming a flow of superheated steam at a very small velocity through a pipe having a length of 100 m, then the steam at the far end will have a lower temperature and a correspondingly larger specific weight, ( $v_1 : v_2 = T_1 : T_2$ ) but practically the same pressure. The highest point *E* in the temperature-entropy diagram shown in Fig. 2, chapter I, 3a, corresponds to the state of the steam at the entrance of the pipe, while the lower point *Q* on the same pressure line represents the state of the steam at the far end. The narrow vertical strip *EFWQE* below the part *EQ* of the pressure line, extending down to the line of zero temperature ( $-273^\circ$ ), represents the total amount of heat lost; but as the heat represented by the area of the diagram below the back pressure line cannot be utilized, the actual radiation loss is represented by the strip *ERVQE*. Insulating and lagging the pipe can therefore only result in a mere reduction of this loss. A further radiation loss occurs in the cylinder and will show itself in a very slight deviation to the left of the vertical adiabatic line. Insulating the cylinder can therefore only tend to reduce this slight loss. Much more important is sufficient insulation around the cylinder heads, which really form part of the steam pipe. The live steam pipe in high grade plants is always covered while the cylinder is provided not only with insulation, but lagging as well. The latter supplements the effect of the insulating material in an efficient manner and may, if constructed of several casings one within another, with a bright inner surface, entirely take its place. All flanges should also be covered. The materials used for insulating steam pipes and cylinders are Kieselguhr, asbestos, magnesia, cork, or glass or textile waste. The more porous the material is, and the thicker the layer, the better will be the insulating effect. Part of the heat is lost by radiation and part by convection. The process is so complicated that mathematical treatment fails completely and actual tests have to be relied upon. The following table will help to clear up matters.

Outside diameter of steam pipe mm	Thickness of Insulation mm	Maximum drop in temperature per 1 m length of pipe, for 14 at. gage; steam pipe insulated, without lagging.								
		300° C steam temperature			350° C steam temperature			400° C steam temperature		
		80 m/sec	60 m/sec	40 m/sec	80 m/sec	60 m/sec	40 m/sec	80 m/sec	60 m/sec	40 m/sec
108	60	0.08	0.11	0.14	0.10	0.14	0.18	0.13	0.19	0.25
	80	0.06	0.09	0.12	0.08	0.12	0.16	0.11	0.17	0.22
	100	0.05	0.08	0.11	0.07	0.11	0.15	0.10	0.16	0.20
133	60	0.06	0.09	0.11	0.08	0.12	0.15	0.10	0.16	0.20
	80	0.05	0.08	0.10	0.07	0.10	0.13	0.09	0.13	0.17
	100	0.045	0.07	0.09	0.06	0.09	0.11	0.08	0.12	0.15
159	60	0.045	0.075	0.09	0.06	0.09	0.12	0.08	0.12	0.16
	80	0.04	0.065	0.08	0.055	0.08	0.11	0.07	0.11	0.14
	100	0.035	0.055	0.07	0.05	0.075	0.10	0.065	0.10	0.12
191	60	0.04	0.06	0.08	0.05	0.075	0.105	0.07	0.105	0.13
	80	0.035	0.05	0.07	0.045	0.07	0.09	0.065	0.95	0.12
	100	0.03	0.045	0.06	0.04	0.06	0.08	0.055	0.85	0.11
216	60	0.033	0.05	0.065	0.045	0.07	0.09	0.06	0.09	0.12
	80	0.03	0.045	0.06	0.04	0.06	0.08	0.055	0.08	0.11
	100	0.025	0.04	0.05	0.035	0.055	0.07	0.05	0.075	0.10
241	60	0.03	0.045	0.06	0.04	0.06	0.08	0.055	0.085	0.11
	80	0.025	0.04	0.05	0.035	0.055	0.07	0.05	0.075	0.10
	100	0.023	0.035	0.045	0.03	0.05	0.06	0.045	0.07	0.09
267	60	0.028	0.042	0.055	0.038	0.057	0.075	0.053	0.08	0.10
	80	0.023	0.035	0.046	0.033	0.05	0.065	0.045	0.07	0.09
	100	0.02	0.03	0.04	0.028	0.042	0.055	0.04	0.06	0.08
292	60	0.025	0.038	0.05	0.033	0.05	0.065	0.045	0.07	0.09
	80	0.023	0.034	0.042	0.03	0.045	0.060	0.04	0.06	0.08
	100	0.020	0.028	0.036	0.025	0.044	0.050	0.035	0.053	0.07
318	60	0.022	0.033	0.043	0.03	0.045	0.06	0.042	0.06	0.083
	80	0.020	0.030	0.028	0.026	0.039	0.052	0.038	0.056	0.075
	100	0.018	0.027	0.034	0.023	0.034	0.045	0.034	0.05	0.068
343	60	0.02	0.03	0.04	0.027	0.041	0.055	0.037	0.058	0.073
	80	0.018	0.027	0.035	0.024	0.036	0.048	0.033	0.05	0.065
	100	0.015	0.023	0.03	0.022	0.032	0.041	0.029	0.043	0.057
368	60	0.018	0.028	0.037	0.025	0.038	0.055	0.035	0.053	0.07
	80	0.016	0.025	0.032	0.023	0.034	0.045	0.031	0.047	0.061
	100	0.014	0.022	0.028	0.021	0.031	0.04	0.027	0.042	0.054
394	60	0.016	0.024	0.032	0.023	0.034	0.046	0.031	0.047	0.062
	80	0.014	0.021	0.028	0.02	0.03	0.04	0.027	0.041	0.055
	100	0.012	0.018	0.024	0.017	0.026	0.034	0.024	0.036	0.048
420	60	0.015	0.023	0.031	0.022	0.033	0.044	0.03	0.045	0.060
	80	0.0135	0.020	0.027	0.010	0.028	0.037	0.026	0.039	0.52
	100	0.012	0.018	0.024	0.016	0.024	0.032	0.023	0.035	0.44

It will be observed from this table that the heat loss for average thickness of insulating material is inversely proportional to the steam velocity. Higher velocities of course result in smaller diameter, circumference and surface of the steam pipe, thus also reducing the heat loss. Higher velocities are therefore advisable up to the point where the throttling losses become excessive (See chapter I, 3a, especially Fig. 2). Heavy insulation (80 to 100 mm thick) is to be recommended. Assuming an outer temperature of  $0^{\circ}$ , then the heat losses increase faster than the temperature gradient, according to the law of Stephan Boltzmann.

If the steam cylinder is regarded as a pipe, the steam may be considered to flow through it with a velocity equal to the mean piston speed. Applying the above rule of the inverse variation of the heat loss with the steam velocity, it will be found that in view of the lower temperature the radiation losses of the cylinder must be extremely small, especially as the oil film and the lagging form part of the insulation. These losses in fact are so small as to appear negligible in comparison with the other losses.

## 7. Losses due to incomplete Expansion.

A loss of diagram area within the limits of the piston stroke is caused by the fact that the exhaust begins with a certain exhaust lead or distance  $f_v$  before dead center (Fig. 1), and this loss increases as the exhaust lead  $f_v$  and terminal expansion pressure  $p_e$  increase. For small exhaust lead and low terminal pressure this loss is negligible. Even in non-condensing una-flow engines in which a large exhaust lead is used in order to soften the exhaust puffs, the loss of diagram area within the limits of the piston stroke is insignificant when compared with the lost work represented by the toe of the diagram, shown shaded at D. The problem of finding a means of utilizing this work without increasing the cylinder dimensions is well worth while. The solution to be described later has the effect of reducing the pressure  $p_u$  at which compression begins, with a consequent lower

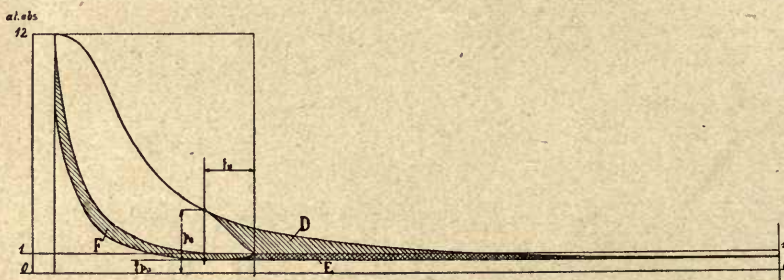


Fig. 1.

terminal pressure. A smaller clearance volume may therefore be used, thus diminishing the volume loss. Without going into calculations, it will be seen that the gain  $F$  at the compression line will be approximately proportional to the shaded area  $D$ , or in other words, the higher the terminal expansion pressure is, or the longer the cut-off, the lower will be the terminal compression pressure. This implies an increasing pressure difference during compression for an increasing pressure difference during expansion, a combination which has been proved desirable in the chapter on volume loss. This rule would be fulfilled in its entirety if the pressure changes on both sides, i. e. expansion and compression, were equal. Furthermore, the use of a longer exhaust lead  $f_v$  would then become permissible, since the lost area within the limits of the piston stroke now forms part of the toe of the diagram, and co-operates in lowering the back pressure at the time compression begins. There can therefore be no objection to making  $f_v$  large, since by increasing the duration of the exhaust, the compression is shortened and the exhaust puffs are softened. If this is done, the number of the exhaust ports will be so far reduced that the exhaust belt may eventually be dispensed with and only one port remains which connects directly to the exhaust pipe. Piston and cylinder also become

considerably shorter. The relation between length of cylinder  $L$ , length of piston  $l_k$ , exhaust lead  $f_v$ , stroke  $l$ , and exhaust port diameter  $d$ , is as follows:

$$l_k = d + l - 2f_v$$

$$L = 2(l_k + f_v) - d = 2l - 2f_v + d.$$

For instance, for a stroke of 660 mm, an exhaust lead of 25% and exhaust ports of 120 mm diameter, the piston length will be 450 mm, and the length of the cylinder 1100 mm as compared with a piston length of 594 mm and a cylinder length of 1254 mm for 10% exhaust lead. The distance  $f_v$  is limited by the maximum cut-off, since direct exhaust of live steam must be avoided. For locomotives the value of  $f_v$  must be limited to 25%, while for locomobiles it may be taken as large as 30 to 35%.

The utilization of the energy represented in the toe of the diagram is based upon its complete conversion into kinetic energy by means of conical nozzles such as are commonly used in steam turbines. Each exhaust puff would therefore act as a kind of wad or plug moving with a high velocity through the exhaust

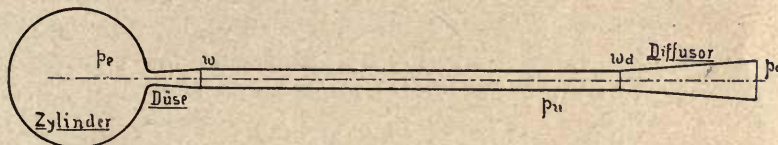


Fig. 2 (Düse = Nozzle).

pipe and finally creating behind itself a partial vacuum whose absolute pressure is  $p_u$ . The exhaust pipe must therefore be long enough so that there will always be at least one such plug moving within it, thus preventing atmospheric pressure from reaching the nozzle and destroying the vacuum. The end of the exhaust pipe must form a diffuser to change the kinetic energy into pressure energy at atmospheric pressure.

Fig. 2 shows such an exhaust pipe diagrammatically. The work corresponding to the shaded areas  $D$  and  $E$  (Fig. 1) is determined for various pressures  $p_u$ . The weights of steam  $G_e$  and  $G_u$ , corresponding to the pressure  $p_e$  and  $p_u$  can be found from the diagram and the dimensions of the engine.

Using the equation of work:

$$(D + E) \text{ mkg} = \frac{G_e - G_u}{9.81} \cdot \frac{w^2}{2}.$$

The velocities  $w$  are calculated for various values of the pressure  $p_u$  and plotted against the latter, as shown in Fig. 3. Each value of  $p_u$  has associated with it a certain velocity  $w_d$  which must exist at the point of entrance into the diffuser in order that atmospheric pressure may be overcome. This velocity therefore corresponds to a pressure difference  $(1 - p_u)$  and may be easily obtained from the Mollier chart and also plotted in Fig. 3. Of course the steam when leaving the diffuser must in practice still have a certain velocity, and the pressure difference should therefore be reckoned not from the atmosphere, but from a slightly higher pressure corresponding to this velocity. This shifts the diffuser velocity curve

into a somewhat higher position, and the intersection *S* of this curve with the nozzle velocity curve, which determines the obtainable pressure  $p_u$ , is moved

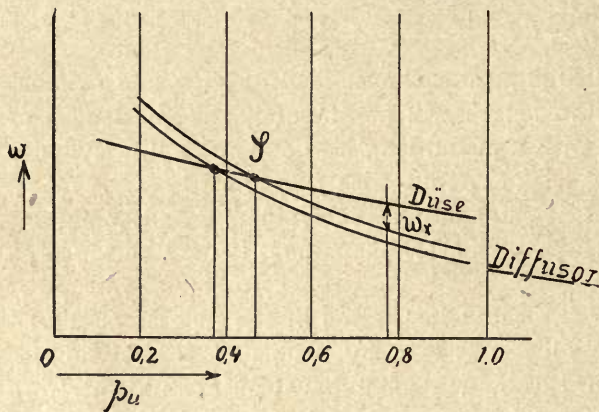


Fig. 3. (Düse = Nozzle).

slightly towards the right corresponding to a higher value of  $p_u$ . Friction losses in the long exhaust pipe cause a further loss of velocity  $\omega_1$ , between the nozzle and the diffusor, and this again results in a shift of the point of intersection to the right, corresponding to a still higher pressure  $p_u$ . The ejector effect of the exhaust puffs will eventually become less and less for higher steam velocities. This will be the case especially in single cylinder engines, because the length of

exhaust pipe required is very great. For instance in an engine running at 180 r. p. m. which corresponds to 6 exhaust puffs per second, and for a steam velocity 0-540 m/sec, the length of the exhaust pipe must be 90 m, or better 100 m. Calculating the loss of pressure required to overcome the resistances by means of Eberle's equation:

$$\Delta p = \beta \frac{l}{d} \cdot \omega^2 \cdot \gamma \quad \dots \quad 1)$$

in which  $\Delta p$  represents the loss of pressure in kg/sqm,  $l$  is the length of the exhaust pipe = 100 m,  $d$  its diameter = 0,1 m,  $\omega$  the steam velocity = 540 m/sec,  $\gamma$  the specific weight = 0.58 kg/cbm and  $\beta$  a constant =  $10.5 \times 10^{-4}$ , then the loss of pressure will be found to be 17.7 at. For  $d = 0.05$  m the loss would be 35.5 at. However, Eberle's tests from which the above formula was obtained, covered only velocities up to 150 m/sec, as did similar tests by Fritsche, Ombeck, Lorenz and Ritschel, so that the results are not directly applicable to velocities higher than the critical value. Such higher velocities will result in still greater losses. In reality the above results will be smaller since the assumed steam velocity will not be constant but decreasing.

It would seem from the foregoing that the direct exhaust ejector principle would not have great prospects if based on complete conversion of pressure energy into velocity. However, as reported by Guldner<sup>2)</sup>, partial vacua have been observed in long exhaust pipes of gas engines, although no special provision had been made to cause and sustain them and a great part of the energy was lost in valves, sharp edges and elbows. There must therefore still remain a possibility of solving this problem in another way. It is, however, not easy of solution, since it involves the calculation of the friction of accelerating and expanding steam, which is very difficult to express in a mathematical form. Actual tests must therefore be relied upon.

<sup>1)</sup> Stodola, „Die Dampfturbinen“. 3d. Edition, p. 55.

<sup>2)</sup> Guldner, „Entwerfen von Verbrennungskraftmaschinen“. 3d. Edition, p. 40.

Although this problem may seem difficult in connection with a single cylinder, it is very simple for multi-cylinder engines, of which the locomotive is the chief representative. Even in an engine having two cranks at right angles, an exhaust lead of 25% will produce sufficient overlap of the exhaust periods so that the exhaust of one cylinder begins before the other has ceased (Fig. 5). If now the exhaust pipes are joined at an acute angle, a jet ejector action is obtained. This effect is well known and widely used in locomotive practice, where the combination of blast pipe and stack also form an ejector, thus producing a partial vacuum in the smoke box which serves to draw off the flue gases. The theory of the blast pipe was first developed by Zeuner in his classical treatise on the subject<sup>1</sup>). An equation in a somewhat simpler form based on this theory, is found in v. Ihering's book, „Die Gebläse". The development of the formula for the ratio  $G_2 : G$  of the quantities of the ejected to the ejecting steam is very lengthy and will not be repeated here. The formula is based upon the principle of the continuity of flow and includes a number of assumptions and simplifications, the most important of which are that friction losses are not considered, but the unfavorable assumption is made instead that the velocity  $\omega_2$  is entirely lost and  $\omega_3 = 0$ . (See Fig. 4.) The following formula then results:

$$\frac{G_2}{G} = \frac{\gamma_2}{\gamma} \sqrt{\frac{m^2 + m \beta n^2}{m^2 + \lambda \beta n^2} - 1} \dots (1)$$

in which

$$\beta = \frac{2\gamma}{\gamma_2}$$

The efficiency of an ejector depends upon the losses due to friction as well as the impact losses at the point where the two streams mix. The impact is to be regarded as absolutely inelastic. Assuming

$\omega_3 = 0$  then the efficiency  $\eta_s = 1 - \frac{G_2}{G + G_2}$ . Since  $G_2$  is small compared with  $G$ , the ejecting stream loses little of its energy, the impact loss is small and  $\eta_s = 0.75$  to  $0.80$ . The efficiency of the blast pipe is considerably lower, being only about  $0.28$ , because the weight of the ejected air is about  $2.6$  times the weight of the ejecting steam. In addition to this there is a further loss equal to the energy contained in the steam at the final section of the stack. A similar loss will occur at the end of the blast pipe in regard to the exhaust ejector action, since the energy contained in the steam at the final section  $F_0$  cannot be utilized for steam ejecting. This finds its expression in equation 1, where  $\lambda$  increases with decreasing

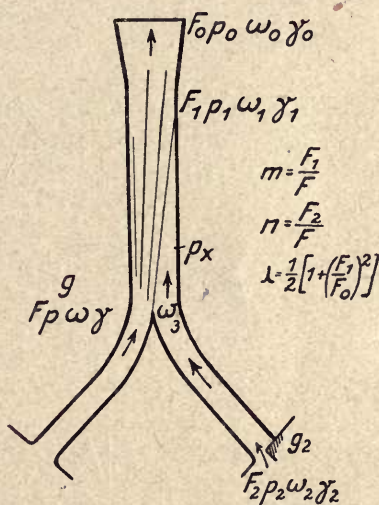


Fig. 4.

- $F$  sectional areas
  - $w$  velocities
  - $p$  pressures
  - $\gamma$  specific weight
- These symbols used without index refer to the junction of the nozzles and the steam at that point;
- Index 2 refers to the variable port opening at the cylinder;
  - Index 1, to the throat of the blast pipe and the mixture;
  - Index 0, to the final section of the blast pipe;
  - $\omega_3$  = the velocity of the ejected steam at the junction.

<sup>1</sup>) Zeuner, „Das Lokomotiven-Blasrohr“. 1863. Zürich. Meyer-Zeller.

$F_0$ . The area  $F_0$  should therefore be made as large as possible, but is limited by considerations in regard to the blast action on the flue gases. Strahl<sup>1)</sup> has developed a formula for the blast pipe area, which is based on Zeuner's treatise and is as follows:  $F = \frac{a \cdot R}{\sqrt{\kappa \lambda}}$ , where  $F$  is the blast pipe area,  $F_1$  the smallest stack area,  $R$  the grate area,  $\lambda$  the coefficient of divergence of the stack,  $\kappa$  the coefficient of flue gas friction from ash pan to stack;  $a = f(m)$ ;  $m = \lambda \cdot F_1 : F \cdot a$  is nearly constant, and  $\cong 0.03$  for  $m = 13$  to 19. The weight ratio of the ejected air  $L$  to the ejecting steam  $D$  is

$$\frac{L}{D} = \sqrt{\frac{\frac{F_1}{F} - \lambda}{\lambda + 5\kappa \left(\frac{F}{R}\right)^2}}$$

A large blast pipe area produces a lower pressure in the cylinder but insufficient vacuum in the smoke box and therefore unsatisfactory steaming of the locomotive. It is self-evident that with a given amount of work available in the

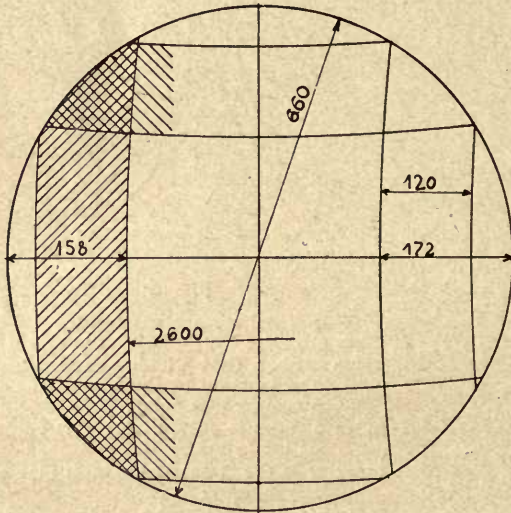


Fig. 5.

toe of the diagram only a certain total of ejector action for cylinder and boiler together can be produced, the distribution of which depends essentially upon the blast pipe area. In addition to the blast pipe area, the dimensions of the stack are also important. Too small a stack area leads to a large velocity loss at the outlet, and too large an area causes a considerable impact in ejecting the flue gases. It follows from this that there must be a best stack area for which, in consequence of the losses being a minimum, the blast pipe area is a maximum. Expressed mathematically,  $a = f(m)$  is a maximum for  $m = 15.5$  approximately, as is demonstrated in the

above-mentioned paper by Strahl. These best stack dimensions must be strictly adhered to in a locomotive in which the ejector effect of the exhaust is utilized, and this leads to considerable difficulties in large locomotives of the present day. The length of the stack is limited to such an extent by the loading gage and the high location of the boiler, that the expansion of the jet leaving the blast pipe may not completely fill out the whole area of the stack, so that air may enter from above through the remaining area and thus partly destroy the vacuum. Actual tests, however, have shown that such loss of vacuum can easily be avoided even with a large stack area.

<sup>1)</sup> Strahl, „Untersuchung und Berechnung der Blasrohre und Schornsteine an Lokomotiven, 1912“, Wiesbaden, C. W. Kreidel.



The further calculations are based on a 0—10—0 freight locomotive of the German State Railways as an example, which is described on page 242. This engine is a two cylinder superheater locomotive with a cylinder bore of 630 mm, a stroke of 660 mm, a driving wheel diameter of 1400 mm and a steam pressure of 12 at. gage. Assumed is an evaporation of 7000 kg/hour, a loss of pressure of 1 at. from boiler to valve, adiabatic expansion and compression at an entropy of 1.7, and three different speeds of 20, 40 and 60 km/hr, which are referred to below as cases I, II and III. The exhaust port of the cylinder, having a diameter of 120 mm, is placed 7 mm off center to compensate for the angularity of the connecting rod of 2600 mm length. The diagram shown in Fig. 5 is based on these figures and the cross-shaded areas represent the periods of overlapping exhaust.

The ejector action is effective only during part of the exhaust period and therefore only the part *A* of the shaded area in Fig. 6 can be utilized for ejector action, the part *B* being lost. An increase in the exhaust lead would of course have the effect of increasing *A* by a part or the whole of *B*; but considerations of evenness and strength of the draft forbid this. Of the total work represented by the area *A*, a part

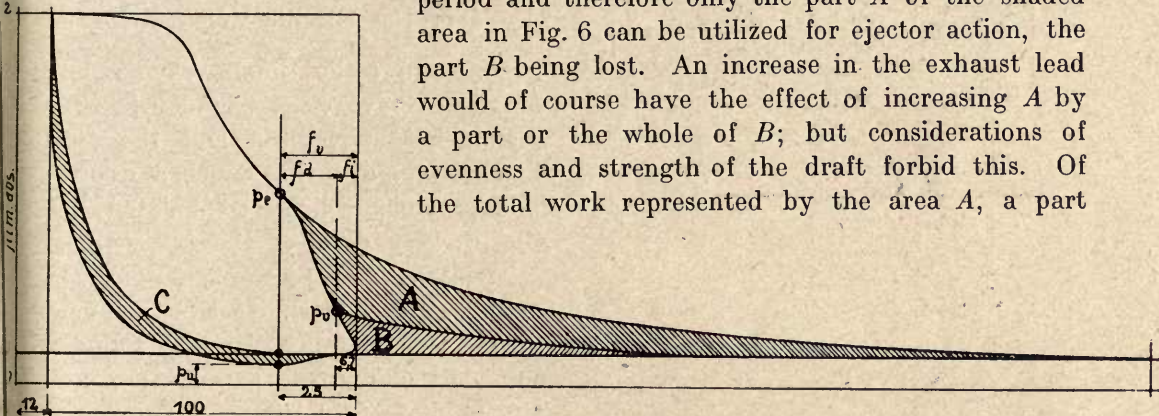


Fig. 6.

is lost in producing the draft in the smoke box by the rush of the steam at high velocity from the nozzle (blast nozzle loss) and a part is lost by throttling and friction in the pipes (pipe loss). Finally, after subtracting the stack loss, there remains the effective gain of work *C* at the compression line, corresponding to an absolute pressure  $p_u$ .

The investigation begins with the determination of the free exhaust port areas for various piston positions within the limits of the exhaust lead  $f_v$ . The secondary nozzle delivering steam to the feed water heater must also be included in this consideration, since the steam passing through it acts in the same way as in the main exhaust pipe. Fig. 7 illustrates the profiles of the main and secondary nozzles, as well as the piston positions at crank angle intervals of  $5^\circ$ . In order to find the smallest areas of opening of the nozzles, the outlines of which are shown shaded in Fig. 7 for  $55^\circ$  before dead center, their plan projections are first laid out and their areas multiplied by  $1/\cos \alpha$ . In calculating the weight of steam flowing through the nozzles, the velocity loss must be taken into consideration by using a velocity coefficient  $\varphi = 0.9$ . On account of the very unfavorable nozzle profiles when first uncovered, with consequent turbulence, it was considered necessary to use a smaller value of  $\varphi$  at first, and therefore, until the nozzle was fully open,  $\varphi$  was put  $= 0.7$  to  $0.9$ . As is shown in Fig. 8, the full opening

is very soon reached, since the piston overruns the nozzle by a considerable amount.

For the several piston positions at intervals of  $5^\circ$ , the weights of steam passing through were calculated by means of the equation  $G = \varphi \cdot F_m \cdot \omega \cdot \gamma \cdot t$ , where  $F_m$

$\psi$	4.5	9.2	13.7	18.0	22.3	26.2	30	34	38	42	I
$\psi$	2.47	2.2	2.03	1.83	1.62	1.47	1.3	1.17	1.0	0.87	II
$\psi$	1.77	1.65	1.52	1.36	1.24	1.09	0.91	0.71	0.5	0.25	2201
$\psi$	0.1	0.25	0.5	0.71	0.71	0.71	0.71	0.71	0.71	0.71	
$\psi$	0.0	0.7	2.35	12.6	12.6	12.6	12.6	12.6	12.6	12.6	
$\psi F$	5	2.0	3.1	5.2	5.2	5.2	5.2	5.2	5.2	5.2	$cm^2$
	50	55	50	45	40	35	30	20	10	0	

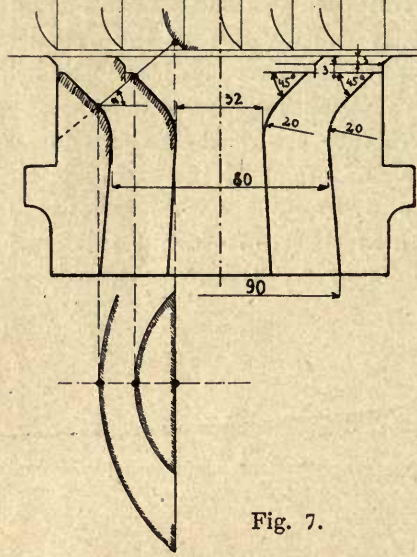


Fig. 7.

at. abs.; the piston however has then fully uncovered the nozzles, and  $F_m$  is therefore constant.

For this period, until atmospheric pressure is reached, the time elements or crank angles were determined by the methods developed in Chapter I, 3a, for finding the losses due to throttling. The results indicated that for small velocities the area was more than ample, and that for higher velocities the exhaust would end at atmospheric pressure without the assistance of the ejector effect.

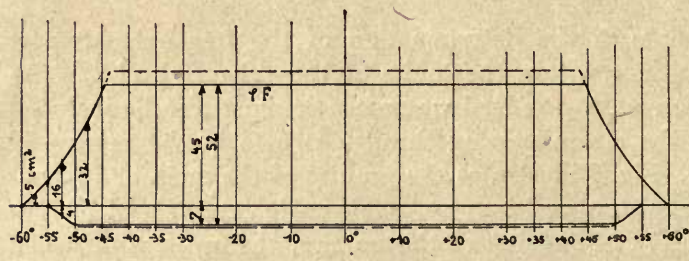


Fig. 8.

It must, however, be considered that all this refers to a freight locomotive which ordinarily runs at speeds of 20 to 40 km/hour and that the back pressures remaining in the cylinder in case III are only slightly above atmosphere. A considerable time is required to exhaust the last tenth of an atmosphere on account of the low pressure difference and the small exhaust velocity. The expansion

and exhaust lines I, II and III shown in Fig. 9 were obtained point by point in this manner, corresponding to speeds of 20, 40 and 60 km/hour. The part of the exhaust line where the ejector action comes into effect was also determined point by point, the weights of steam ejected  $G_2$  being calculated by means of equation (1).

As long as the pressure in the cylinder is above the critical value  $p_k = 1,73$  at. abs., the pressure energy can only be completely converted into kinetic energy by the use of conical nozzles; otherwise the jet will still possess some pressure, and the suction effect will be diminished on account of the lower velocity consequent on the decrease in specific volume. In equation (1) this is taken care of by an increase in  $\gamma$ . The theoretical as well as the actual factors of divergence  $\psi$  and  $\psi'$  were therefore calculated according to the rules of steam turbine design,

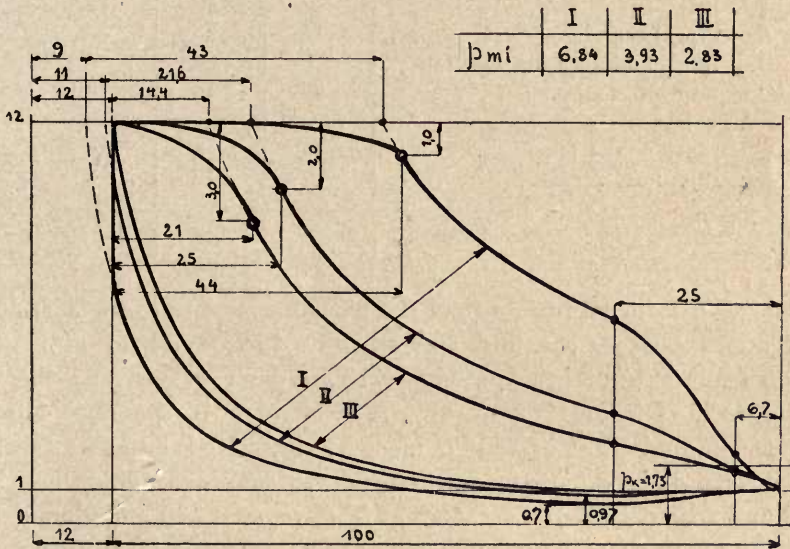


Fig. 9.

and are also tabulated in Fig. 7. According to these figures the actual divergence is insufficient in case I for crank angles of  $-50^\circ$  to  $-30^\circ$ . A correction was therefore made in the calculated values of  $G_2$ . In case II the actual divergence is almost, and in Case III exactly correct, so that  $G_2$  need not be corrected. The compression lines in Fig. 9 were laid out in accordance with these results, and it is found that the initial compression pressures are respectively 0.7, 0.97 and 1.0 at. abs. for cases I, II and III.

The very small pressure reduction in cases II and III makes it desirable to analyze the losses during the exhaust period. The blast pipe loss can easily be calculated since we know the weights of steam exhausted during the time the piston travels the distances  $f_a$  and  $f_i$ , as well as the blast pipe area and the specific volume corresponding to atmospheric pressure. With these data the mean steam velocity at the outlet of the blast pipe and the corresponding energy may be calculated. To be exact, instead of taking the mean velocity  $w$ , it would be neces-

sary to find the value of the integral  $\int_0^{\delta} \omega^2 d\delta$  but for a rough approximation this is not necessary. The amount of work represented by the areas *A*, *B* and *C* may be found with a planimeter, and the efficiency of the ejector is determined by the ratio of  $G_2 : G$ , so that the remainder represents the pipe loss. The major part of the latter is caused by the throttling of the steam when entering the nozzle. A high vacuum is formed in the exhaust pipe just before and after beginning of compression but it only partly reaches the cylinder. This is taken into consideration in equation (1) by taking a lower value of  $n$ . The following table gives the relative amounts of the different losses.

Case	I	II	III
Area A:			
Blast nozzle loss . . . . .	40	25	14
Pipe Loss . . . . .	14	30	56
Impact loss during ejection . .	8	4	0
Gain of compression . . . . .	27	15	0
Area B:			
Blast nozzle loss . . . . .	1	9	22
Pipe loss . . . . .	10	17	8
Total . . . . .	100	100	100

It will be seen from this table that the blast nozzle loss (part *A* and *B* taken together) is approximately constant and amounts to from 41 to 36%. The pipe loss increases from 24% at low speeds to 44% at high speeds, and the work represented by area *B* from 11% to 30% respectively. It therefore follows that at high speeds the bad effect of area *B* must be eliminated, and this can be easily accomplished with a three cylinder locomotive. In such an engine, having cranks at 120° and an exhaust lead of 25%, there will always be two cylinders exhausting at the same time. The ejector effect begins at the dead center and proceeds with greater nozzle areas in the cylinder wall, with the result that the throttling loss and pipe loss are also reduced. The loss of work may therefore be divided in all three cases as follows:

Blast nozzle loss . . . . .	40%
Pipe loss . . . . .	24%
Impact loss . . . . .	8%
Useful work . . . . .	28%

Assuming this division of losses, and taking the mean effective pressures from the indicator cards, the following figures were obtained for two and three cylinder locomotives.

The three cylinder locomotive also shows only a surprisingly slight gain due to the ejector effect at high speeds or early cut-offs. This is explained by the fact that the utilization of the toe of the diagram is equivalent to an enlargement of the cylinder. If the cut-off is early, then a further increase in expansion will not produce much gain. The steam consumption figures are already so low that

	I	II	III
Two Cylinder Locomotive.			
Mean effective pressure, with ejector effect, kg/sqcm	6.84	3.93	2.83
Mean effective pressure without ejector effect . . . . . kg/sqcm	6.1	3.83	2.83
Gain due to ejector effect . . . . . %	12.2	2.6	—
Indicated . . . . . HP.	940	1080	1170
Steam consumption (7000 kg/hr) divided by IHP.	7.45	6.47	6.2
Three Cylinder Locomotive.			
Loss area $A + B$ . . . . . kg/sqcm	2.7	0.67	0.33
Compression gain 0,28 ( $A + B$ ) . . . . kg/sqcm	0.75	0.19	0.093
Mean effective pressure, with ejector effect kg/sqcm	6.85	4.02	2.923
Gain due to ejector effect . . . . . %	12.3	5.0	3.0
Indicated . . . . . HP.	940	1110	1200
Steam consumption (7000 kg/hr) divided by IHP.	7.45	6.3	5.8

not much more could be desired. *The saving of 12% for late cut-offs is noteworthy, because it is based on very conservative assumptions. Furthermore, the exhaust ejector effect allows of a considerable reduction of clearance volume; for instance, in the case under consideration, from 17 to 11%. Taking into account the saving due to the un-a-flow principle a total saving of 15% may be expected with certainty. This saving is all the more important since it occurs at heavy loads and therefore increases the hauling power of the locomotive by this amount.*

Although in describing the exhaust ejector principle locomotives were considered exclusively, its field of usefulness is not limited to the latter. It may also be found advantageous in street railway locomotives, road rollers and stationary engines, as well as locomobiles which are still frequently built with two cylinders so that they may be started from any crank position, which is desirable for instance in peat pressing plants.

### 8. Prof. Dr. Nägel's Experiments.

A series of extremely interesting experiments on the temperature conditions in a una-flow cylinder were conducted by Prof. Nägel in the engineering laboratory of the Technische Hochschule, Dresden, and described by him in the Zeit-

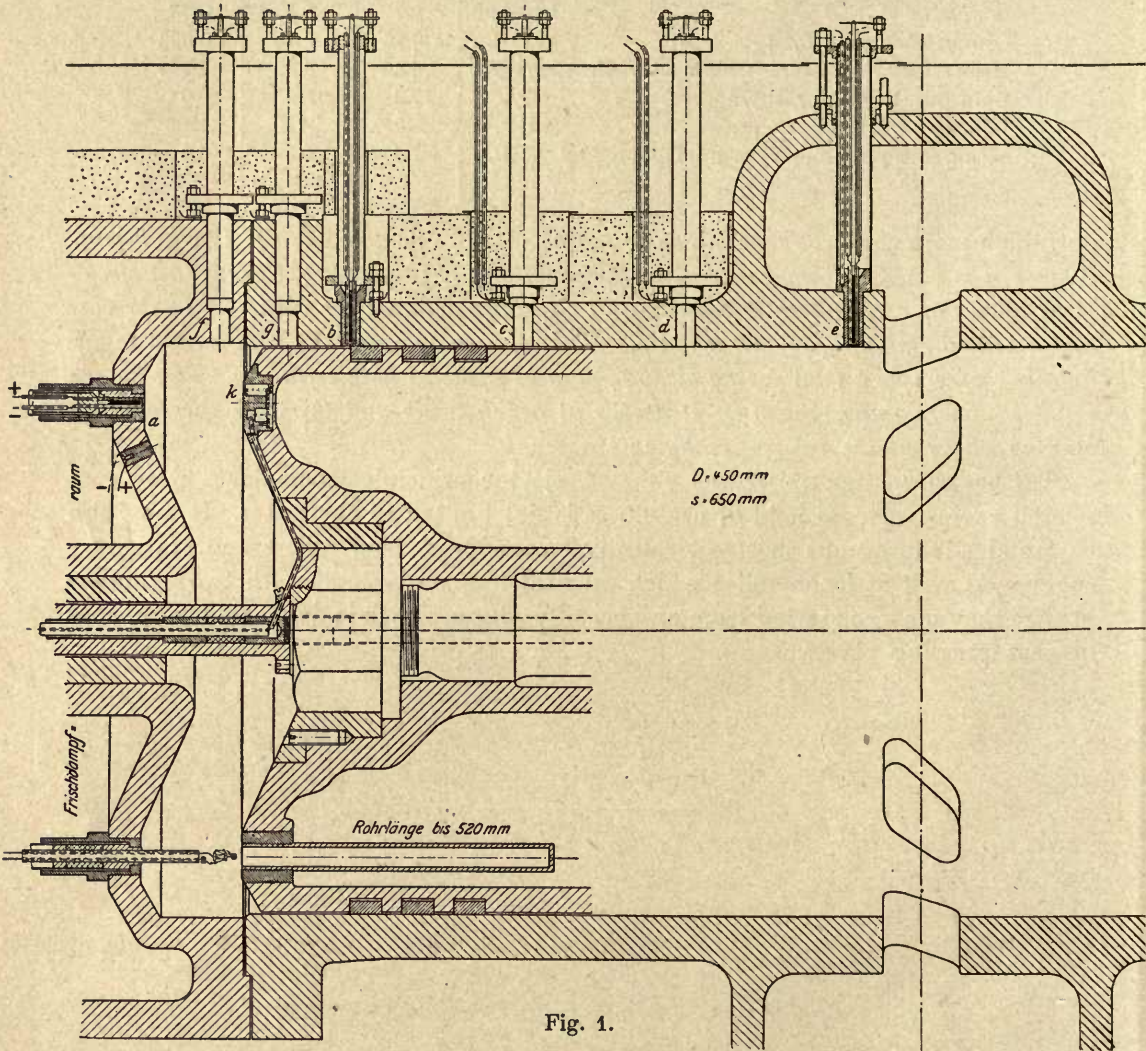


Fig. 1.

schrift des Vereines deutscher Ingenieure Vol. 1913, No. 27, July 5. Part of his report is as follows:

“After Prof. Stumpf had published his first communications on the character and success of the una-flow steam engine a number of years ago,

Dr. Mollier and the author approached the Verein deutscher Ingenieure with the request for an appropriation for investigating the temperature conditions in a una-flow cylinder. This request was granted in the most whole-hearted manner. At the same time the Saxon Government provided considerable sums for the completion of the testing plant. The una-flow cylinder used for this purpose in the engineering laboratory of the Technische Hochschule, Dresden, was built by the Nürnberg Works of the Maschinenfabrik Augsburg-Nürnberg, and took the place of the low pressure cylinder of the existing triple-expansion engine. It was put into operation during September 1911. The cylinder as shown in Fig. 1, has a bore of 450 mm and a stroke of 650 mm, and the engine runs at 150 r. p. m.

In order to determine the thermal peculiarities of the Stumpf cycle it was planned to measure the temperature changes of the working steam at different points in the cylinder. It was later also found desirable to measure

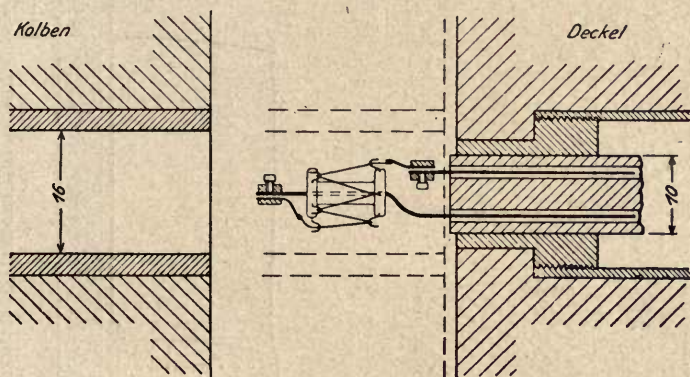


Fig. 2. (Kolben = piston; Deckel = cover).

the temperature variation of the cylinder wall. The determination of the steam temperatures offered great difficulties. It was at first attempted to use thermocouples of copper and constantan wire of 0.2 mm diameter. Tests of a similar nature on a counterflow engine in the laboratory, using the same elements, had been started five years ago, but a critical examination showed that their sensitiveness is by no means sufficient to follow the changes of temperature with the necessary speed. After long and futile experiments with thermocouples composed of thinner wires down to 0.07 mm diameter, it was found, according to a test report published in an American periodical, that wires of so small a diameter as 0.01 mm were required for the thermocouple to be sufficiently sensitive. It seemed impossible to produce thermocouples with wires of this thinness on account of the difficulty in making the junction, and for this reason the use of electric resistance thermometers was decided upon early in 1912. The material for the latter was obtained in the form of drawn tungsten filaments as used in electric lamps. A wire of about 50 mm length was wound in zigzags upon a glass frame provided with platinum hooks for this purpose, as shown in Fig. 2. The main difficulty was a satisfactory connection of the resistance unit to the lead wires in order to enable the thermometers so con-

structed to resist the effect of the steam currents inside the cylinder. The measurement of wall temperatures was rendered difficult by the fact that the insertion of the measuring unit into the cylinder wall necessitates the drilling of a hole which more or less disturbs the heat flow. This may be the cause of an erroneous temperature indication. In order to reduce this possibility to the utmost, the arrangement illustrated in Fig. 3 to 5 was employed. A hole of 15 mm diameter was drilled in the cylinder wall, into which was closely fitted a cast iron plug having a hole of 9 mm diameter bored to within 0.5 mm of the bottom. Into this hole was fitted a second cast iron plug having two drilled holes of 2 mm diameter from end to end. These holes contained the copper and constantan wires of 0.1 mm diameter insulated by small glass tubes, their

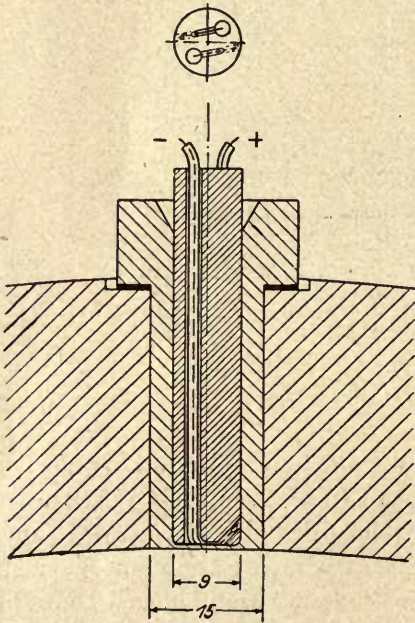


Fig. 3 u. 4.

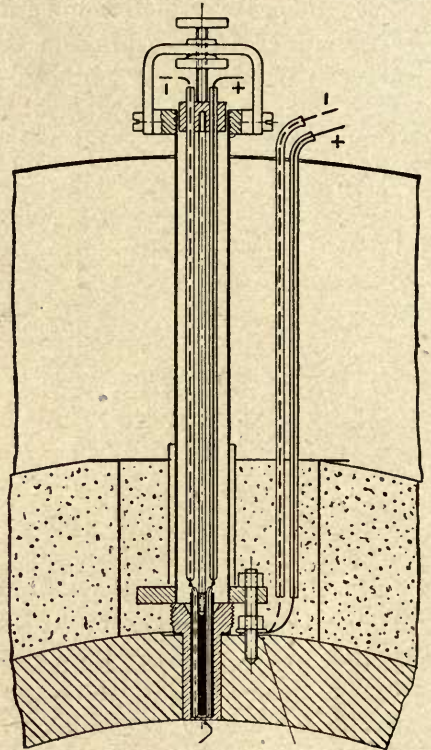


Fig. 5.

ends being embedded in grooves at the bottom surface of the cast iron plug. A thermocouple of similar construction was also fitted to the piston, as indicated at *k*, in Fig. 1, and in Figs. 6 and 7. The leads of this thermocouple were carried through the hollow tail rod, provided with a porcelain lining for this purpose.

For measuring the change in voltage corresponding to the changes in temperature, a galvanometer made by Edelmann in Munich was employed. According to Fig. 8, it consists of a powerful electromagnet which is supplied with current from a storage battery. In the magnetic field is stretched a filament of gold or platinum having a diameter of from 0.002 to 0.005 mm, which carries the current to be measured. The displacement of this wire due to electro-



magnetic forces is a measure of the current flowing through the circuit, and therefore also a measure of the temperature. This displacement, although amounting to only a fraction of a millimeter, is projected on an enlarged scale onto the focal plane of a camera by means of a beam of light from a source  $L$  and a system of microscope lenses. The photographic plate is moved proportionately to the piston travel or crank angle behind a slit in the focal plane,

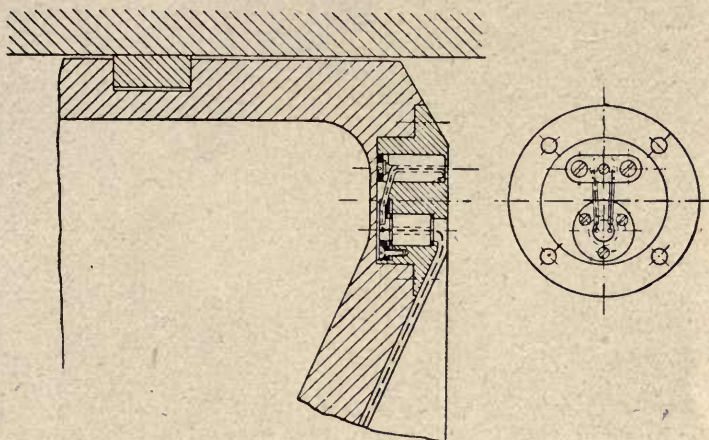


Fig. 6 u. 7.

thus producing a photographic record of the changes of temperature with stroke or time. Special methods were devised for rapid calibration of the displacement of the filament. In Figs. 9 and 10 are reproduced two records of steam and wall temperature based on time. The remarkable feature about

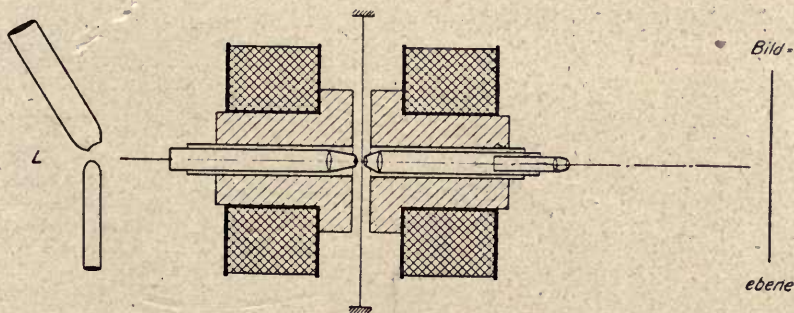


Fig. 8. (Bildebene = Focal plane.)

the temperature change of the working steam is the fact that at the end of compression the latter attains temperatures of such a magnitude as were hitherto thought impossible. A terminal compression temperature of about  $500^{\circ}$  was observed when running with saturated steam of 10 at. gage. The wall temperature was measured at the points  $a, b, c, d, e, f, g$  and  $k$ , indicated in Fig. 1. The change of temperature at the end of the cylinder barrel at point  $b$  is of considerable significance. A series of tests made with constant cut-off

Temperature time diagram of steam close to cylinder head surface. (Point of measurement a.)

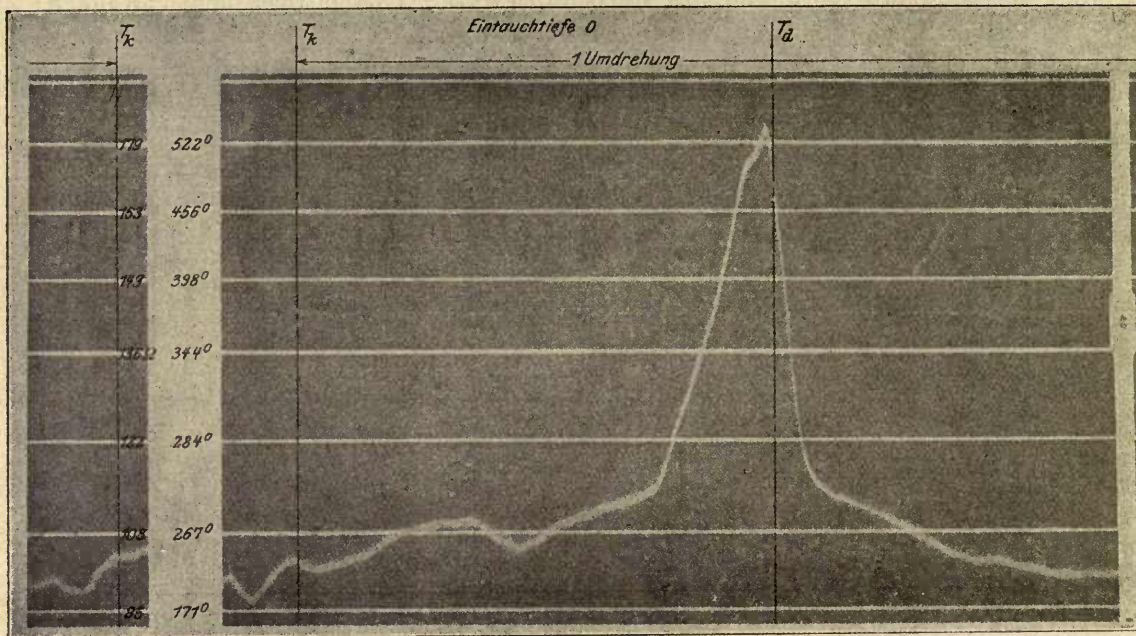


Fig. 9.

Temperature time diagram of cylinder wall at a depth of 0,5 mm from inside surface. (Point of measurement d.)

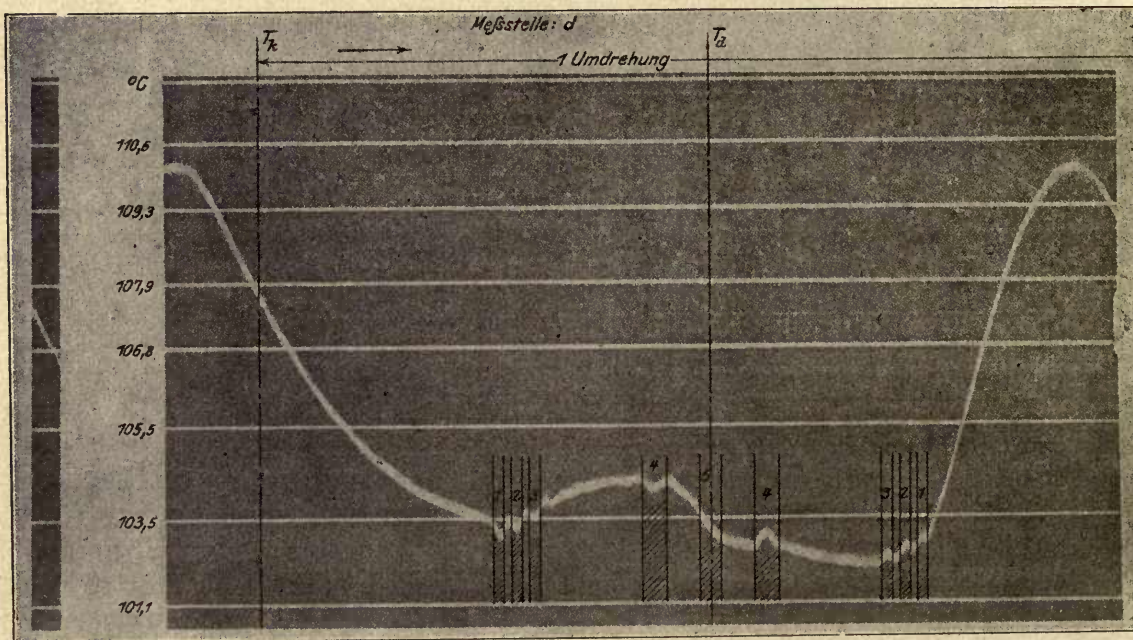


Fig. 10.

of 10% and saturated as well as superheated steam of different temperatures showed that the highest mean temperature at this point was reached when operating with saturated steam; even superheated steam of 350° did not produce the same high wall temperature. The sensitiveness of the thermocouples was raised to such a degree that the passing of every piston ring over a point of measurement produced a clearly discernible wave. The moment of passage of the several rings over the thermocouple is clearly indicated in Fig. 10 by the shading between the various lines; the diagram was taken at point *d*."

The above report also includes descriptions of the several instruments which were used during the tests and for the analysis of their results. Among others, there are mentioned a harmonic analyser by Mader, an instrument fitted with a microscope for measuring indicator cards, made by H. Maihak, of Hamburg, and an apparatus furnished by Steinmüller, of Gummersbach, for automatically measuring the condensate, which proved to be very exact.

The temperature diagram in the above report by Prof. Nägel merits particular attention. Instead of a terminal compression temperature of 500° for 3.3% clearance, a final temperature of 900° should be obtainable with a clearance volume of 1%. While on the one hand the terminal compression temperature was 500° for saturated steam, it decreased to 480° or 450° for increasing degrees of superheat. This may probably be attributed to the more energetic heating action of the steam jacket in the case of saturated steam. Prof. Nägel further states that the temperature at the point *b* of the cylinder wall, for 12% cut-off and saturated steam of 184° in the jacket, was 128°, which fell to 111° for the same cut-off and superheated steam of 220°; and again slowly rose to 118° for a further increase of the initial steam temperature to 350°. The temperature of the inner cylinder head surface was 177° for an initial or jacket steam temperature of 184°, the total variation during one revolution being only 0.5°. The temperatures at the points *b*, *c*, *d*, (Fig. 1) were found to be 128°, 102° and 83°, with a total fluctuation of 3°, 3° and 2.8° respectively. At the point *k* on the piston, distant 36 mm from the cylinder wall, the temperature was found to be 164.5° with a total fluctuation of 1.3°. Attention is especially called to the latter figures, since they prove the statements previously made concerning the favorable thermal action of the piston head surface. At the points of measurement the heat had to penetrate a metal thickness of 0.65 mm. It will also be noticed in Fig. 9 that a very pronounced kink occurs in the temperature curve where the steam changes from the saturated to the superheated state, and also that an abrupt drop in temperature takes place at the moment of admission, from the high terminal compression temperature of about 530° to that of the live steam.

The contrary effect of heating by the jacket steam and cooling by the cylinder steam at the point *a* is also evident in Fig. 9, as well as the corresponding small temperature fluctuation at this point during the complete cycle, considered apart from the sudden rise due to the heat of compression. The comparatively high mean temperature and small fluctuation at the point *d* are also noticeable in Fig. 10.

In Fig. 11 is shown an especially clear temperature diagram in which the kinks in the compression and expansion lines corresponding to the change from saturated to superheated steam are clearly noticeable.

There is a surprisingly high temperature during the last part of expansion, the first part of compression and especially during exhaust (about  $100^{\circ}$ ), although the engine was operated with a vacuum of 98%. As this card was taken at the cylinder side of the cover, the explanation is easily found in the great flow of heat from the cover to the working steam during that time.

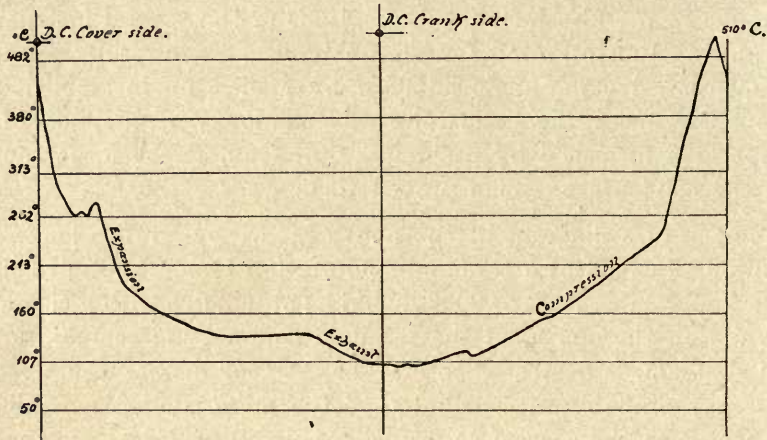


Fig. 11.

The drop of temperature through the cylinder head wall was found to be  $7^{\circ}$  to  $8^{\circ}$  for saturated steam,  $15^{\circ}$  for steam of  $250^{\circ}$ , and  $25^{\circ}$  for steam of  $350^{\circ}$  initial or jacket temperature.

A close study of the temperature diagrams given in Figs. 9 and 10 and 11 has as its final result a confirmation of the thermal advantages of the una-flow principle and the jacketing of the heads.

This is still more emphasized by the comparison of the una-flow temperature diagram (Fig. 11) taken by Prof. Nägel with a counter-flow temperature diagram taken by E. T. Adams & T. Hall from a common slide valve engine of the Sibley College-Cornell University, as shown in Fig. 12. The comparison elucidates the striking thermal difference between both engines. Whereas the una-flow engine shows the highest temperature at the inlet end and the lowest at the exhaust end, the counter-flow engine shows quite a thermal mixture distributed over both strokes. Interesting is the postponement of the phases of high metal temperature caused by the preceding phases of high steam temperature in the counter-flow engine.

CHART OF TEMPERATURES FROM STUMPF UNA-FLOW STEAM ENGINES MADE BY PROF. NÄGEL COMPARED WITH THOSE FROM A SLIDE VALVE ENGINE BY ADAMS & HALL

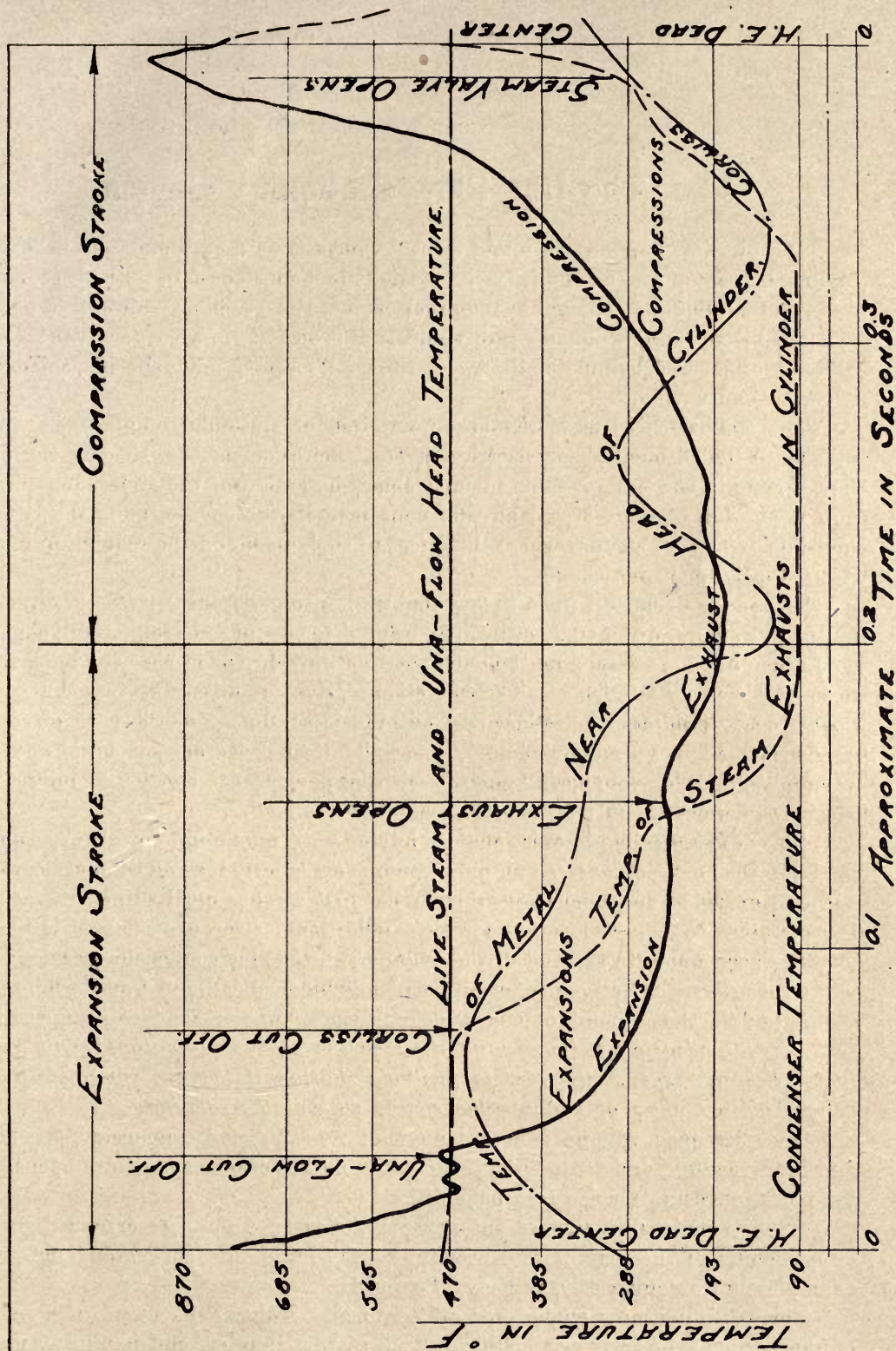


Fig. 12.

## II. 1. The Una-Flow Stationary Engine.

The una-flow engine has found a very wide use as a stationary prime mover mainly by reason of its simplicity, its straight line construction, its high economy and its adaptability to changing load requirements. The tandem counterflow engine which still comes occasionally into competition with it, is at a disadvantage on account of its two cylinders, its two pistons, its piping and the inaccessibility of its exhaust valves.

The conditions of close regulation required of stationary engines, in which may be included engines for electric current generation, are satisfied in the una-flow engine in the best possible manner since the action of the governor is direct and is not impeded by steam already contained in the engine, as is the case in multiple expansion engines where the effect of such steam on the regulation makes itself unpleasantly noticeable.

The range of cut-off in una-flow engines is usually from 0 to 25%, although cut-offs are found up to 40%, or even 50 or 60% for instance in rolling mill engines. The range of the governor must include zero cut-off, in which case the inlet valve does not open at all. The lead of the steam valves at all cut-offs must be kept down to the minimum or reduced to nothing if possible, since large lead causes condensing engines to knock badly, especially if the clearance is large and the vacuum high. Non-condensing engines with large clearance and long compression always run quietly and can therefore stand more lead.

It is easily possible to start engines having 25% maximum cut-off even under load and with a directly driven air pump, more particularly if an additional clearance space is provided and opened up during the first strokes until sufficient vacuum is generated. The best location for these additional clearance pockets is in the cylinder head opposite the end of the cylinder, so that for condensing service they will act as a very effective insulation between cylinder head and frame, while providing double the amount of cover jacket surface for non-condensing operation.

*Every condensing stationary una-flow engine should be equipped with additional clearance spaces in order to facilitate starting if the air pump is directly driven, and to allow of running the engine without the condenser.*

The clearance volume averages about 1.5 to 2% for condensing operation and high vacuum, and 13 to 28% if the additional clearance spaces are opened up for non-condensing service (see page 48).

In non-condensing engines the necessary clearance may be arranged in the cupped ends of the piston. On account of the large work of compression such engines require comparatively heavy flywheels.

Since the una-flow engine has only two inlet valves, the use of a lay-shaft is unnecessary. As is shown in Figs. 1 to 3 of this chapter, and in Figs. 4 and 5 (page 10), the inlet valves may be driven from an eccentric on the crankshaft

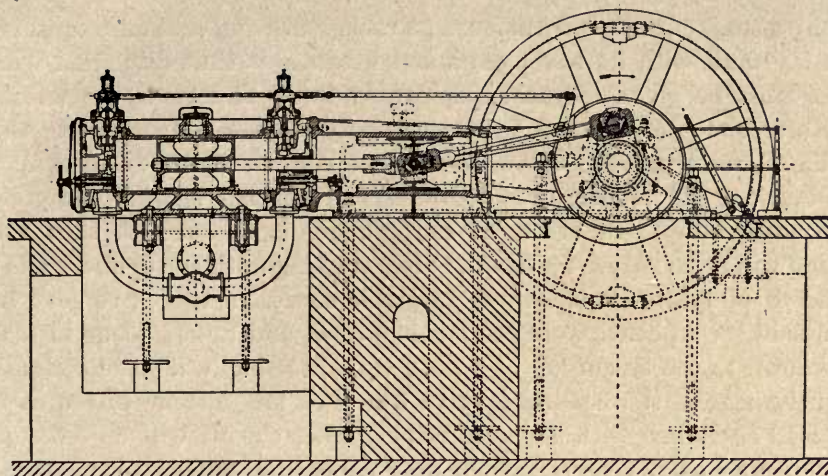


Fig. 1.

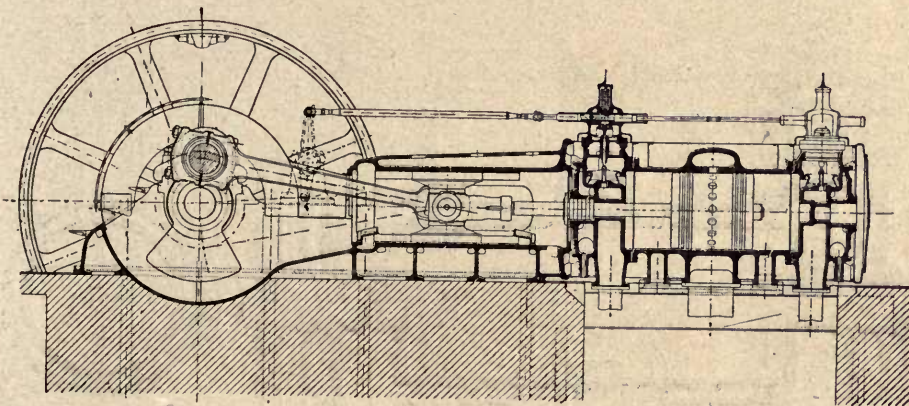


Fig. 2.

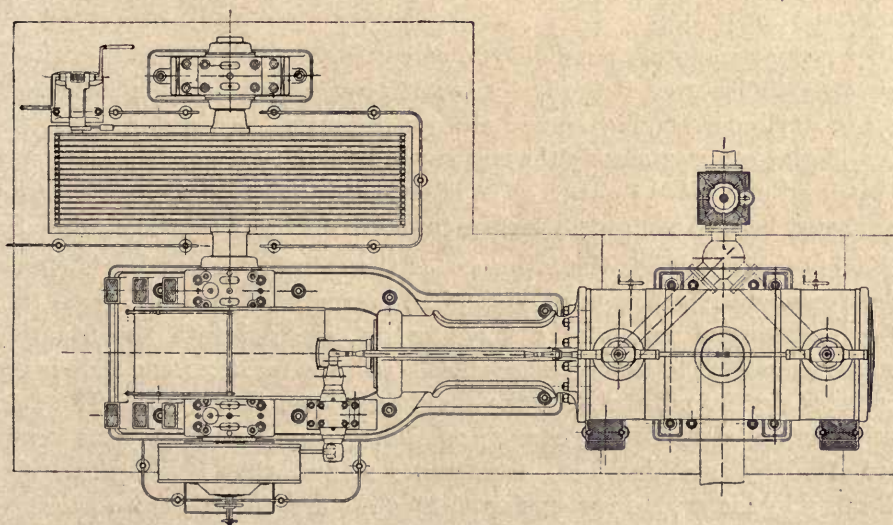


Fig. 3.

acted on by a shaft governor, by means of a rocker arm and cam mechanism (Stumpf gear). A lay-shaft with its bevel gears and bearings is thus dispensed with. Consideration must be given to the expansion of the cylinder. If the latter is provided with steam jackets receiving their supply from a connection to the steam pipe ahead of the main stop valve, then the cylinder may be warmed up prior to starting, and the valve gear, if set correctly for the hot engine, will give proper distribution from the very start. If the cylinder is unjacketed, then the steam distribution will be incorrect for a while after starting until the cylinder has reached its expanded condition. It is always advisable to design the valve gear with outside admission, or in other words to arrange cams and rollers so as to make their action conform to the steam lap of a slide valve, so that while the cylinder is still insufficiently heated, the head end valve will open late instead of too early. This negative lead combined with a simultaneous earlier cut-off will do less harm than an early opening of the valve, which may cause the engine to knock.

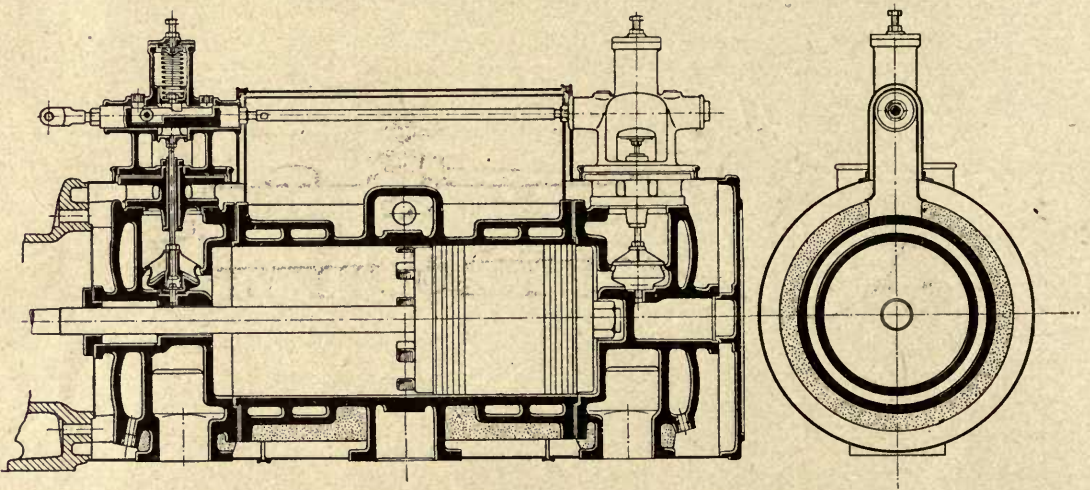


Fig. 4.

There remains another possibility of correcting the bad influence of the expansion of the cylinder even if the latter is not provided with steam jackets, by extending the cylinder lagging around the rod between the valve bonnets (Fig. 4), thus heating it to approximately the mean cylinder temperature. It is also possible to drive the head end valve through an equal-armed rocker mounted at the center line of the exhaust belt. This insures permanent correct motion for the head end valve.

If a lay-shaft is used, the influence of the cylinder expansion is eliminated, and the steam distribution must always be correct.

Fig. 5 illustrates details of a valve bonnet as used with the Stumpf gear. The cam is connected to the valve crosshead, and the reciprocating slide is grooved to accommodate the roller and at the same time form an oil bath. The guide for the reciprocating slide is long enough so that the groove never runs beyond it, the loss of oil by splashing and the entrance of dust thus being prevented. The oil collecting in the groove is transferred by the roller to the cam, so that perfect lubrication and reliable operation of these important parts is insured.



Fig. 6 shows a twin una-flow engine with Stumpf gear, in which a jack shaft having two crank throws is driven by a pair of eccentrics on the crank shaft set at  $90^\circ$ . This jack shaft carries a shaft governor acting upon an eccentric on each side of it, which operates the valve mechanism of its corresponding cylinder through a rocker arm. In this way the valve gears are positively connected, so that both of them always give the same cut-off. The short vertical eccentric rod also helps to equalize the cut-offs of both cylinder ends, and the small diameter of the jack shaft facilitates the design of the governor. This engine possesses great reserve power since each half is able to carry the whole load.

The elimination of exhaust valves and their gear will be found very convenient in horizontal engines, since it leaves the whole space underneath the cylinder free for piping and permits of a close arrangement of the condenser. (See Figs. 2 to 5, chapter I, 3b, p. 69—70.)

The Erste Brünner Maschinenfabrik-gesellschaft was the first concern to take up the una-flow engine, and decided to rebuild an old 80 HP. single cylinder condensing engine with a forked frame by fitting it with a una-flow cylinder, designed by the author, having a bore of 400 mm and a stroke of 420 mm (Fig. 7). On the free end of the crank shaft was mounted a shaft governor acting on the eccentric operating the inlet valves by means of a rocker arm on the exhaust belt and a pair of Lentz cam mechanisms. Although this first design was susceptible of improvement in many respects, its economy even with rather low vacuum was equal to that of a compound engine of the same size.

Fig. 8 shows another engine built by the same Company.

Shortly after the latter had taken up this work, the Elsässische Maschinenfabrik decided on a large scale experiment. Their first una-flow engine, built to the author's design, had a cylinder bore of 640 mm and a stroke of 1000 mm, with a rated load of 500 HP. (Figs. 1 and 9). This engine, which was directly connected to an electric generator, was tested by the Elsässische Verein der Dampfkessel-Besitzer (Alsatian Association of Steam Boiler Owners), on February 21, 1909. The result of a trial of four hours and eight minutes duration showed a steam consumption of 4.6 kg/IHP-hour for an initial steam pressure of 12.6 at. gage and a temperature of  $331^\circ\text{C}$ , at a speed of 121 r. p. m. This is a very creditable

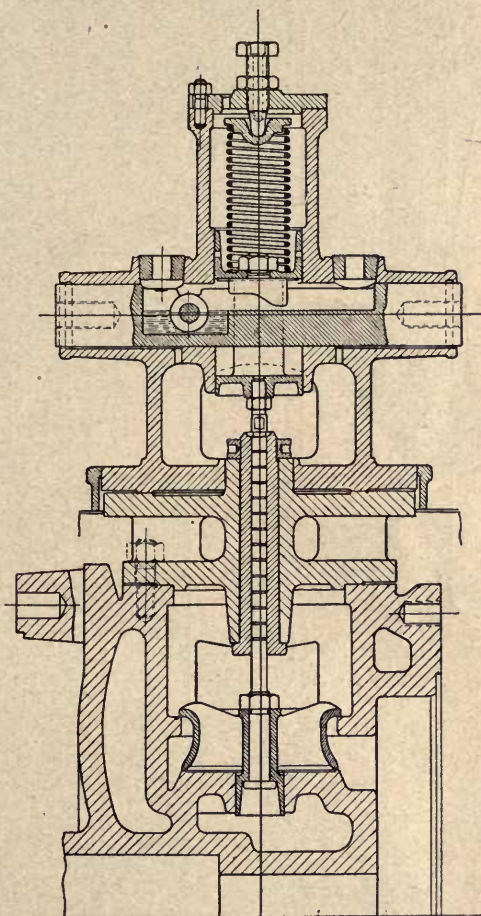
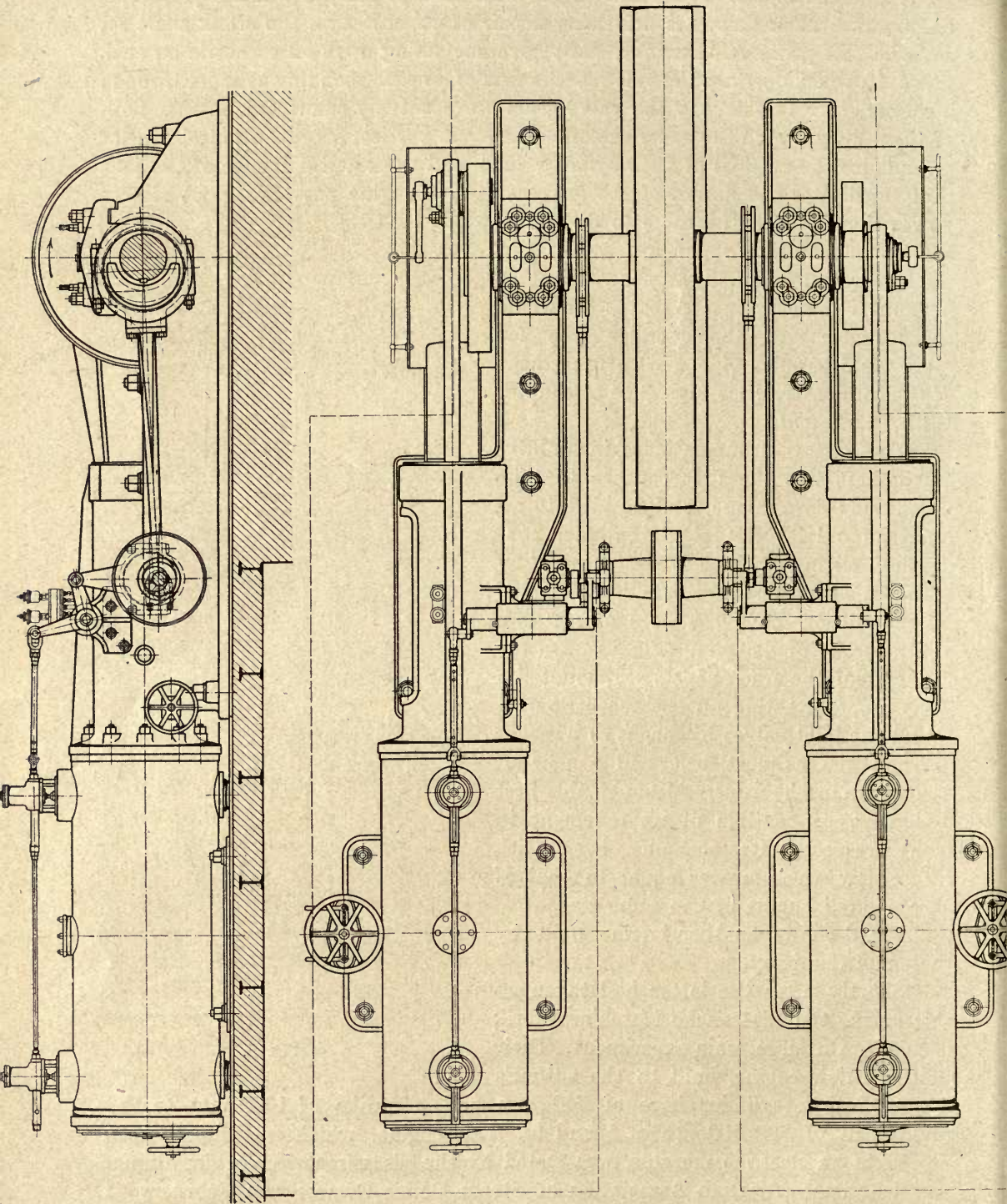


Fig. 5.



result if it is borne in mind that the engine did not derive the full benefit from the vacuum on account of too small an exhaust pipe and the use of an oil separator between cylinder and condenser. (Back pressure 0,145 at. abs.) By correct design

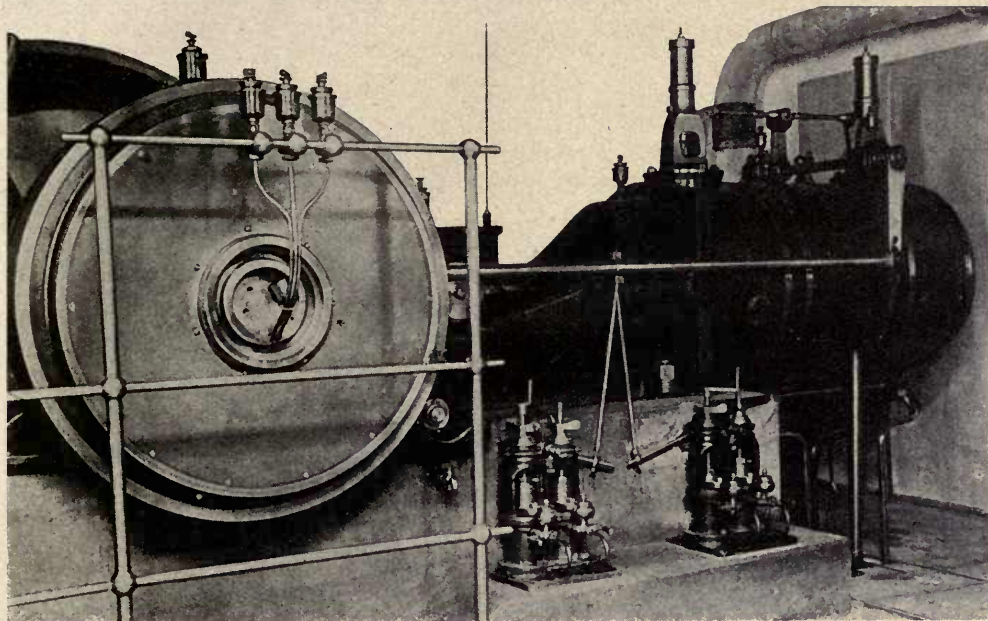


Fig. 7.

of the condensing equipment in the way previously suggested, by jacketing of the cylinder, and the use of tighter valves, the steam consumption could be considerably diminished, as proved by later engines built by the same makers.

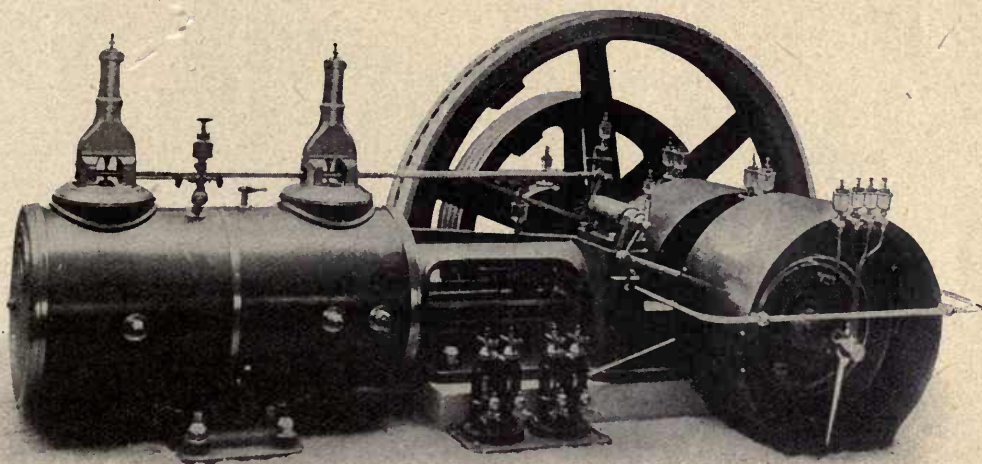


Fig. 8.

Figs. 2 and 3 show a una-flow engine of 900 HP rated load built by the same firm. Noteworthy is the heavy frame, the engine being of center crank construc-

tion which is now used by several concerns. The center crank type is advantageous where the forces on the moving parts are heavy, especially for large short stroke engines.

In Figs. 10 and 11 is shown still another engine by the same makers, as well as its governor and valve gear parts.

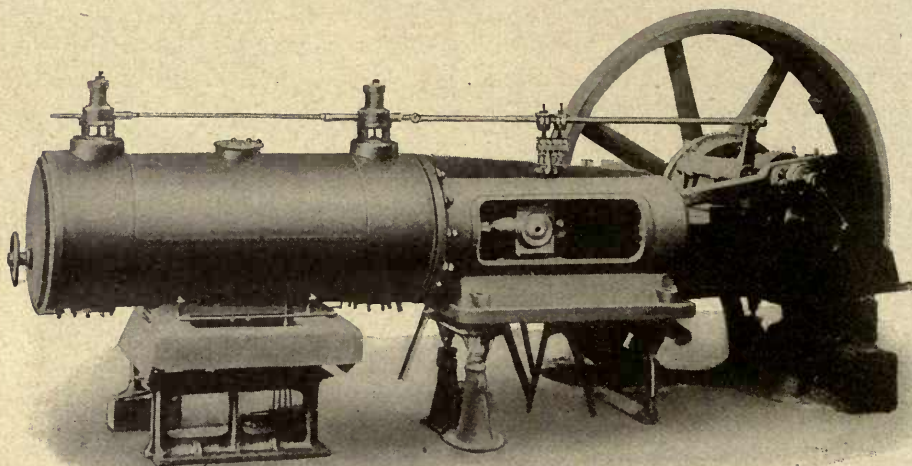


Fig. 9.

A una-flow engine built by Burmeister & Wain, of Copenhagen, and designed by the author, is shown in Figs. 12 and 13. The direct connection of the condenser to the cylinder should be noted, as well as the method of supporting the

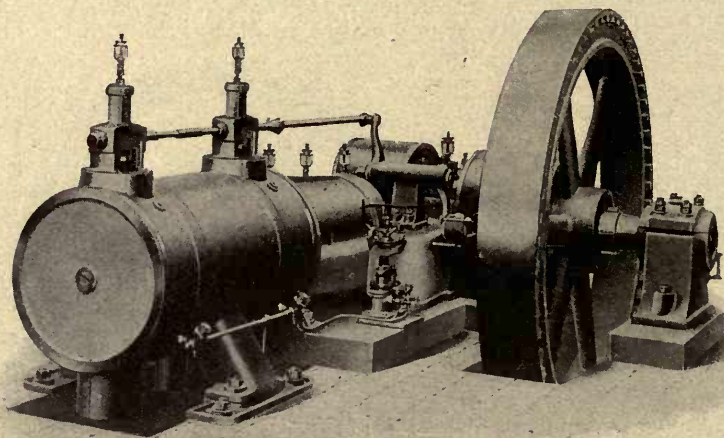


Fig. 10.

rear end of the latter on two adjustable rods, and the simple air pump drive. The cylinder is left unjacketed on account of the use of superheated steam (Fig. 14). The head jackets, however, are carried up to the point of normal cut-off. The

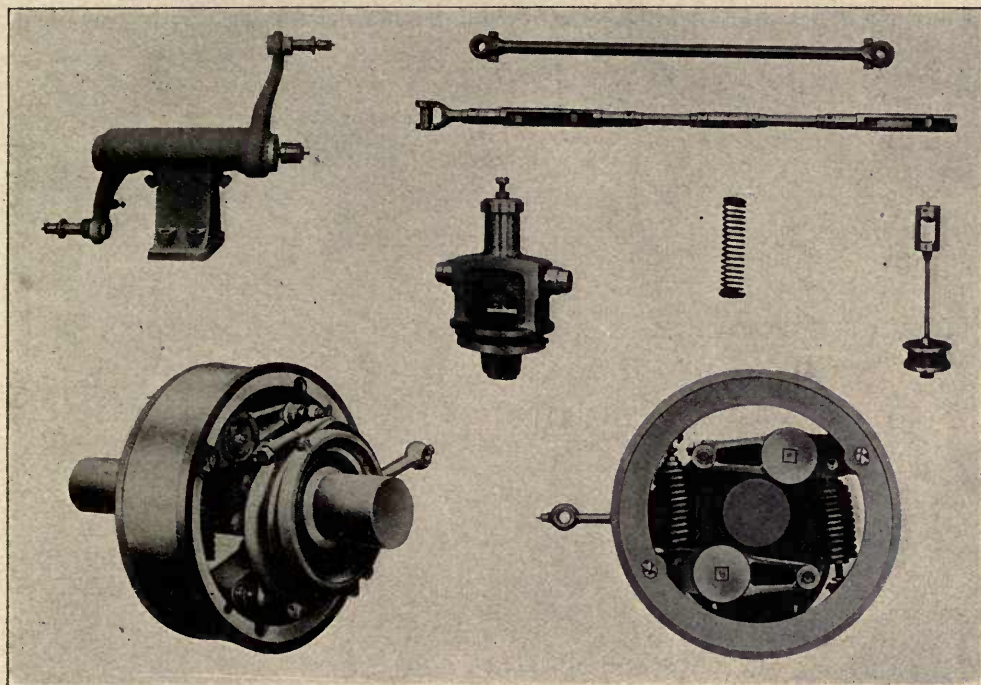


Fig. 11.

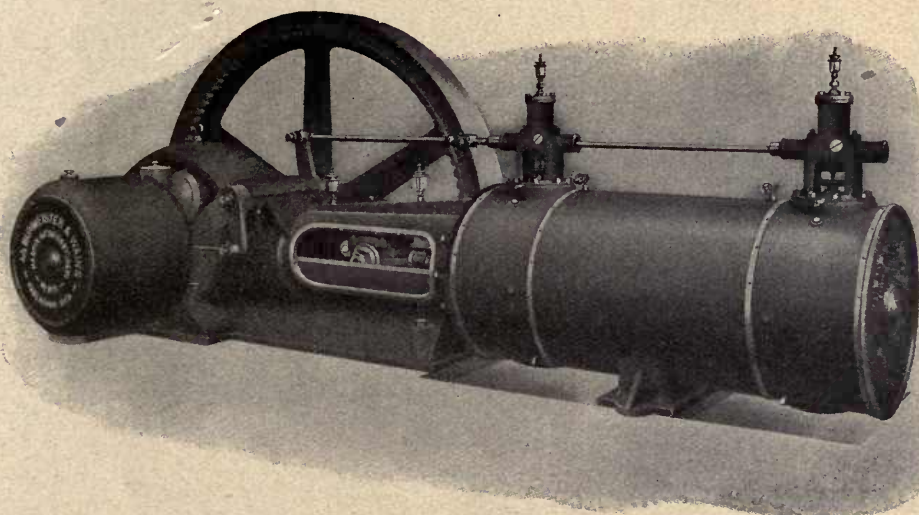


Fig. 12.

piston is turned to a smaller diameter for a corresponding distance to provide for expansion. The additional clearance pockets are fitted with two clearance valves, one on each side of the inlet, one of which is sufficient for starting, while the

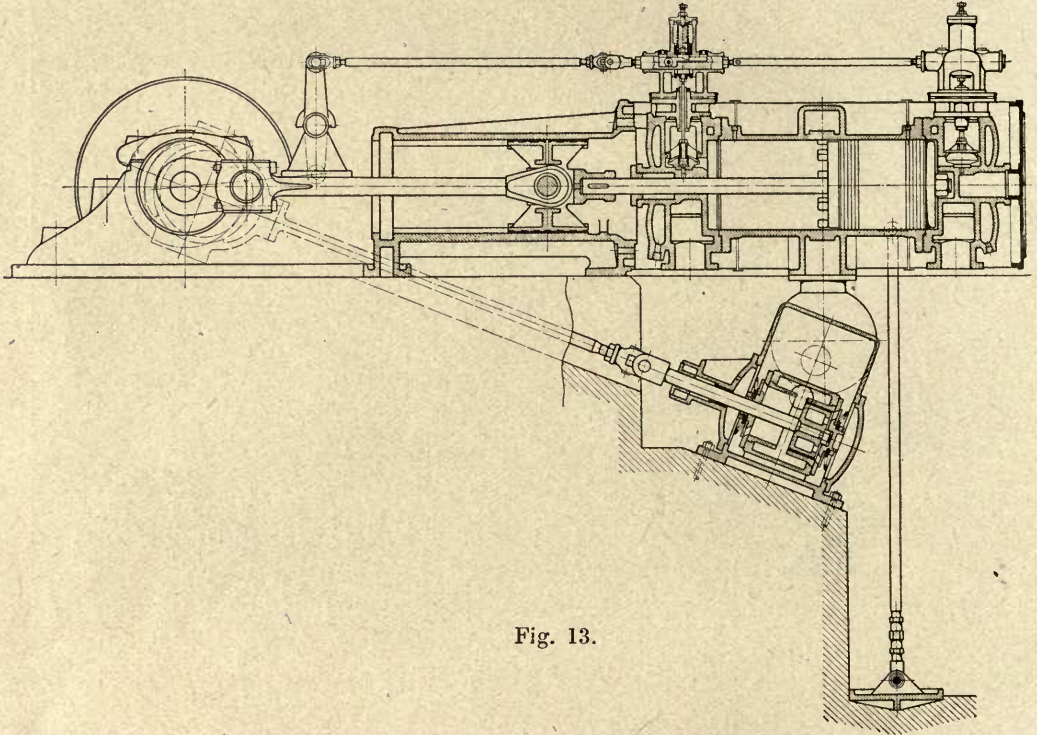


Fig. 13.

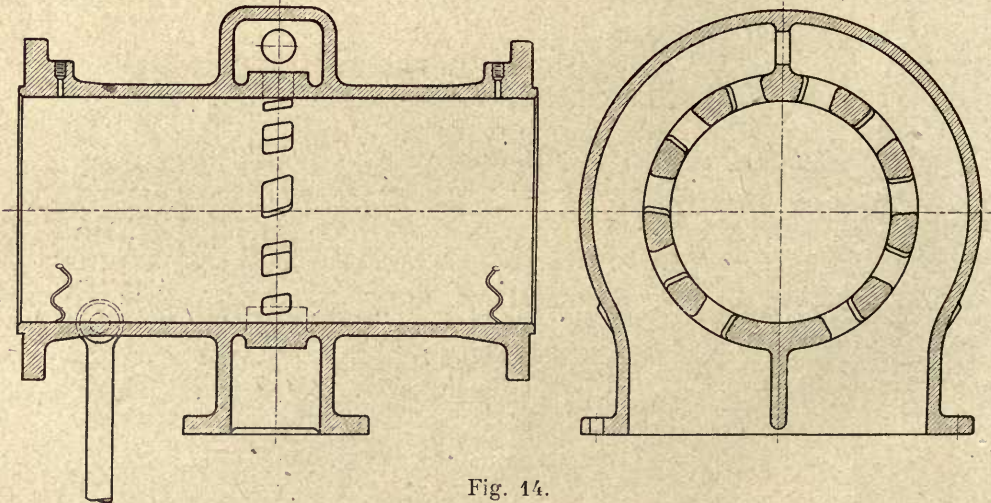


Fig. 14.

second one has to be opened for non-condensing operation at full speed (Fig. 15). The area of contact between cylinder head and frame is kept as small as possible in order to reduce the conduction of heat to a minimum. The cylinder head casting is perfectly symmetrical so as to increase its range of usefulness.

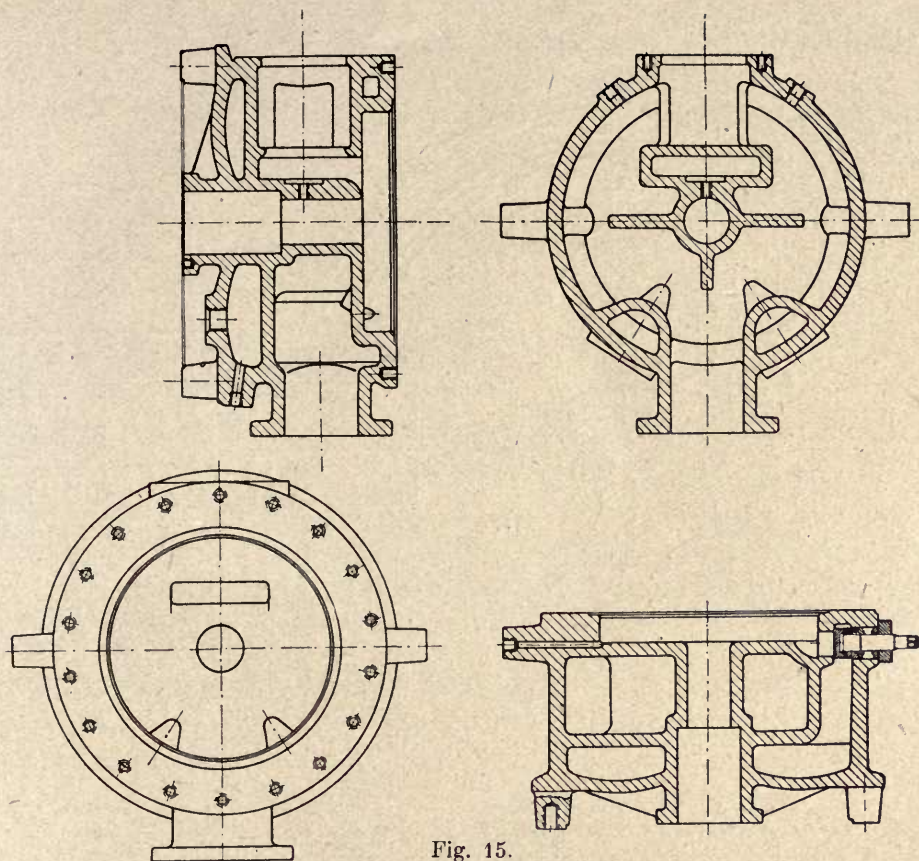


Fig. 15.

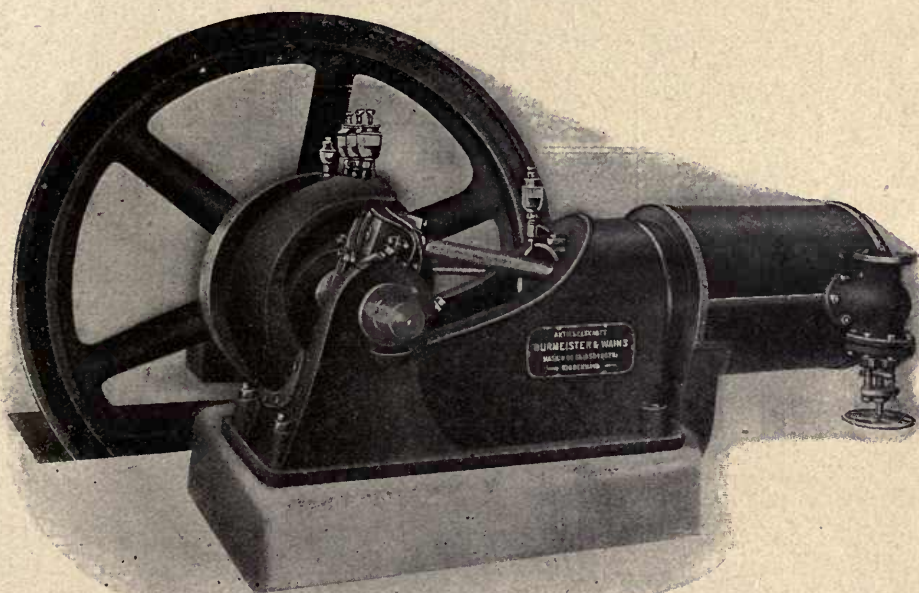


Fig. 16.

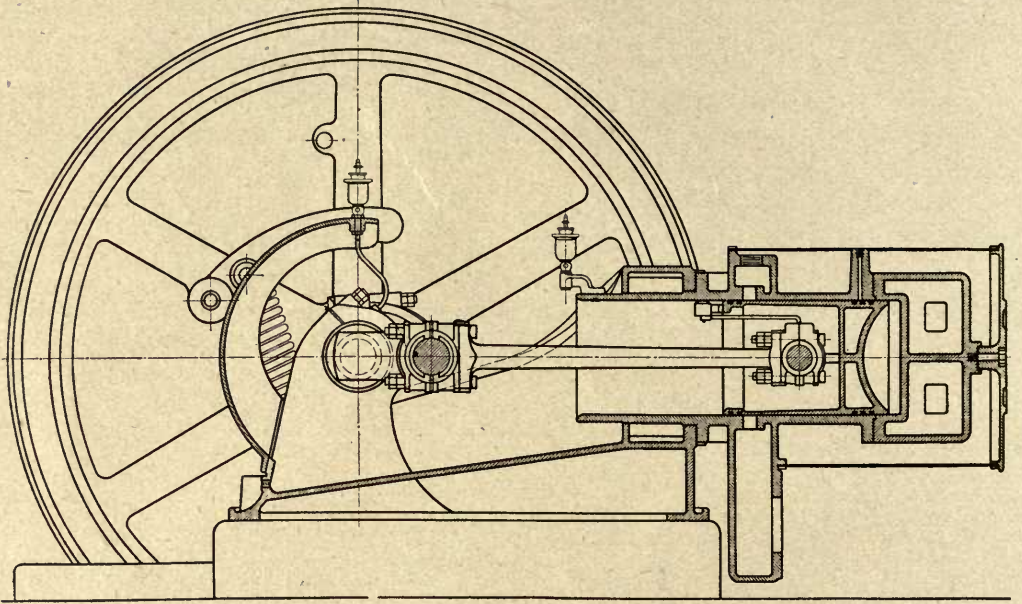


Fig. 17.

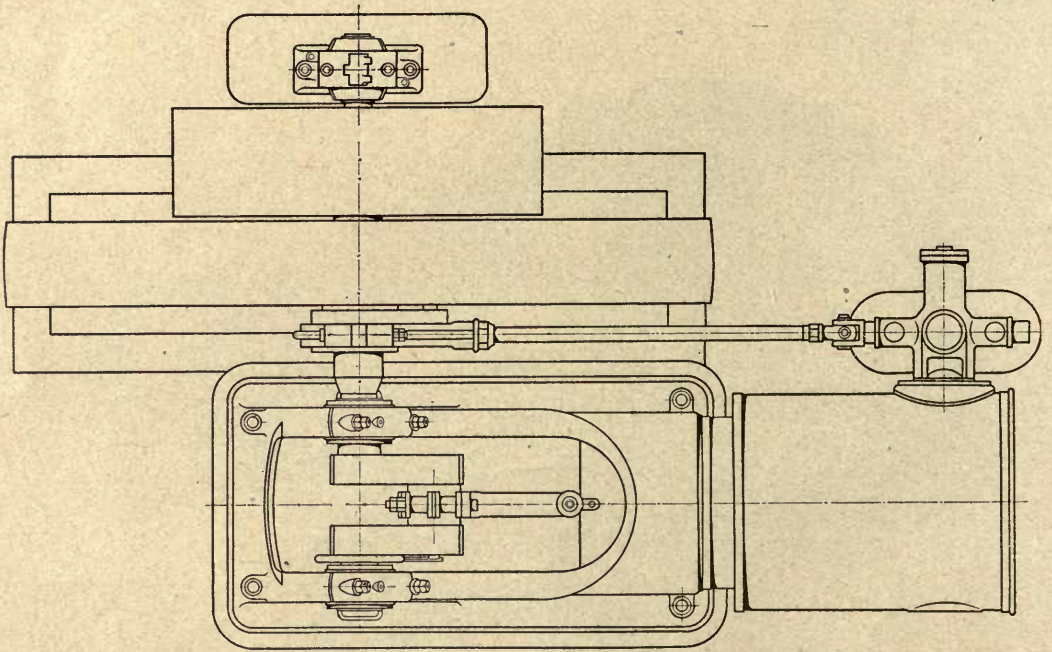


Fig. 18.



Tests made with this engine by Mr. Bacher, Professor at the Technical Hochschule in Copenhagen, showed the following results.

Load			Pressure kg/sqcm	Steam Tempe- rature °C	Vacuum in % of 760 mm	r. p. m.	Steam Con- sumption kg/hr.	Steam Consumption		
KW	BHP	IHP						KW/hr.	BHP/hr.	IHP/hr.
64.50	98.7	116.0	9.90	352	94.0	179.0	479.0	7.44	4.86	4.12
86.46	130.0	149.0	9.87	354	93.8	175.0	632.0	7.32	4.86	4.24
108.66	163.0	184.5	9.84	353	93.5	176.5	798.4	7.36	4.90	4.34
131.24	197.0	222.0	9.80	353	92.6	173.5	976.7	7.45	4.97	4.40
109.00	164.0	186.0	9.75	dry saturated	93.0	178.0	1150.6	10.55	7.03	6.20

In view of the omission of the cylinder jackets, these results are in close agreement with the tests of a 300 HP una-flow engine given on p. 11.

A single-acting una-flow engine built by Burmeister & Wain is shown in Fig. 16. Engines of this type are widely used in Danish dairies. The horizontal valve is operated by a cam mechanism directly connected to a shifting eccentric on the crank shaft. (Figs. 17 and 18.)

A stationary engine built by Ehrhardt & Sehmer, of Saarbrücken, for the power plant of the Saar Valley Railway, is shown in Fig. 19. This engine has

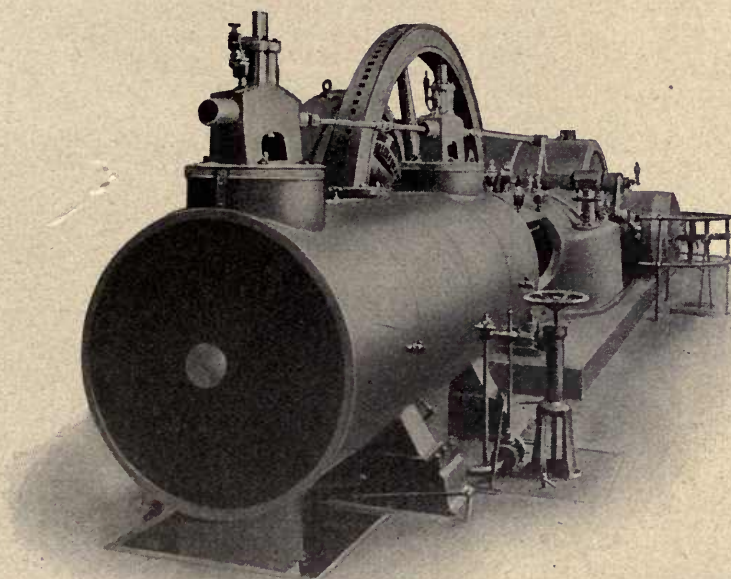


Fig. 19.

a cylinder bore of 650 mm, a stroke of 1000 mm, and a rated load of 500 HP at a speed of 130 r. p. m. It has run for long periods at an overload of nearly 100%. The average cut-off of una-flow engines at rated load being only about 10%, their

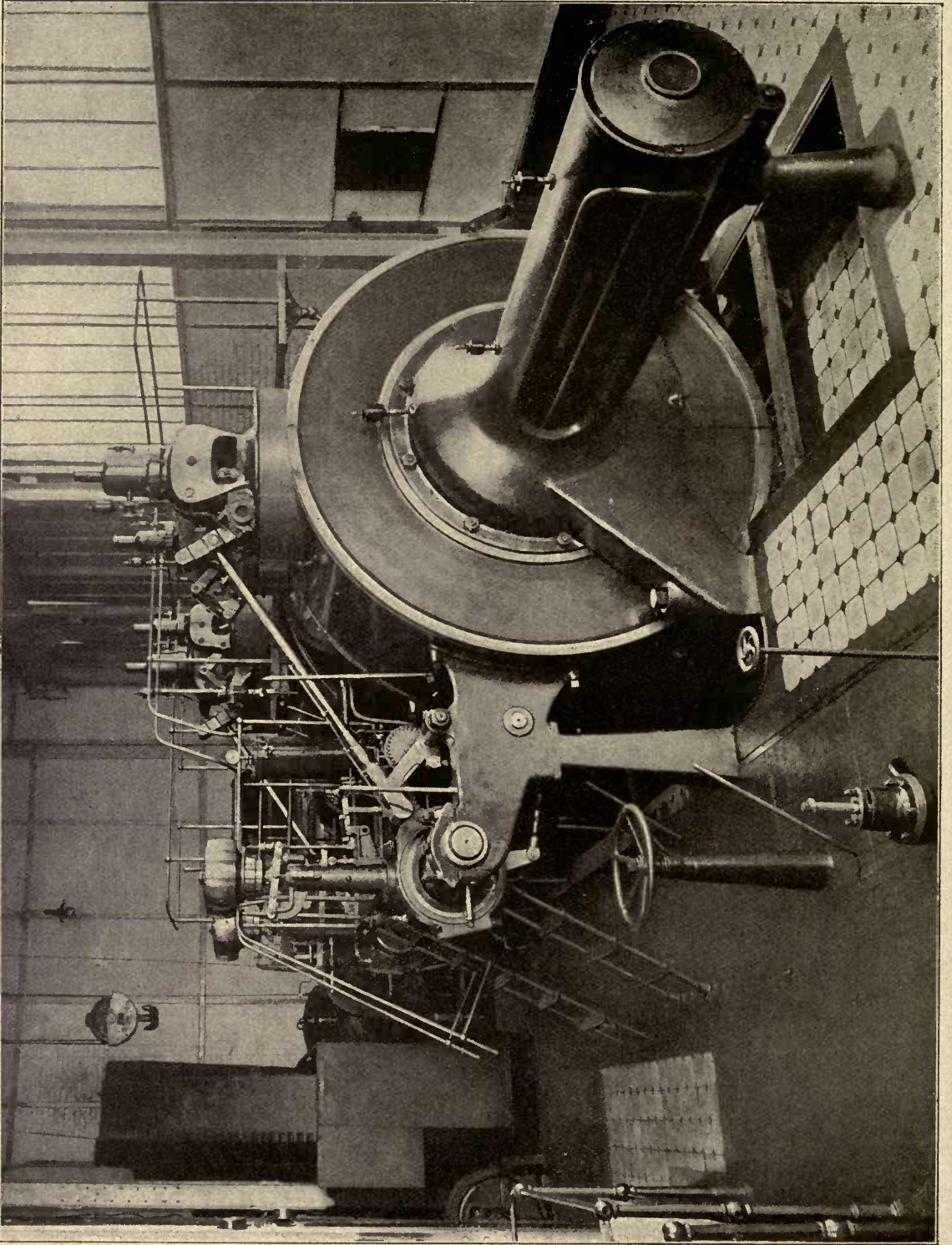


Fig. 20.

capacity for overload is far greater than that of any other type of engine. If the dimensions of the driving parts are based upon the initial pressure less the inertia, then even a heavy overload does not materially increase the load upon them.

In Fig. 20 is shown the largest una-flow engine so far built, constructed by Ehrhardt & Sehmer for driving a rolling mill at the steel works of Gebrüder Röchling, at Völklingen, having a cylinder bore of 1700 mm and a stroke of 1400 mm, the speed being 110 to 130 r. p. m. The cylinder was made with this large bore on account of the low steam pressure available at the time, and is provided with two inlet valves at each end for this reason. Later on, when new high pressure boilers have been installed, it is intended to substitute for the present cylinder a smaller one with only one valve at each end.

Another una-flow engine built by the same firm and delivered to the Aplerbeck steel works, is illustrated in Figs. 21 and 22. The cylinder bore is 1450 mm, the stroke 1500 mm, the speed 100 r. p. m., and the steam pressure 8 at. gage.

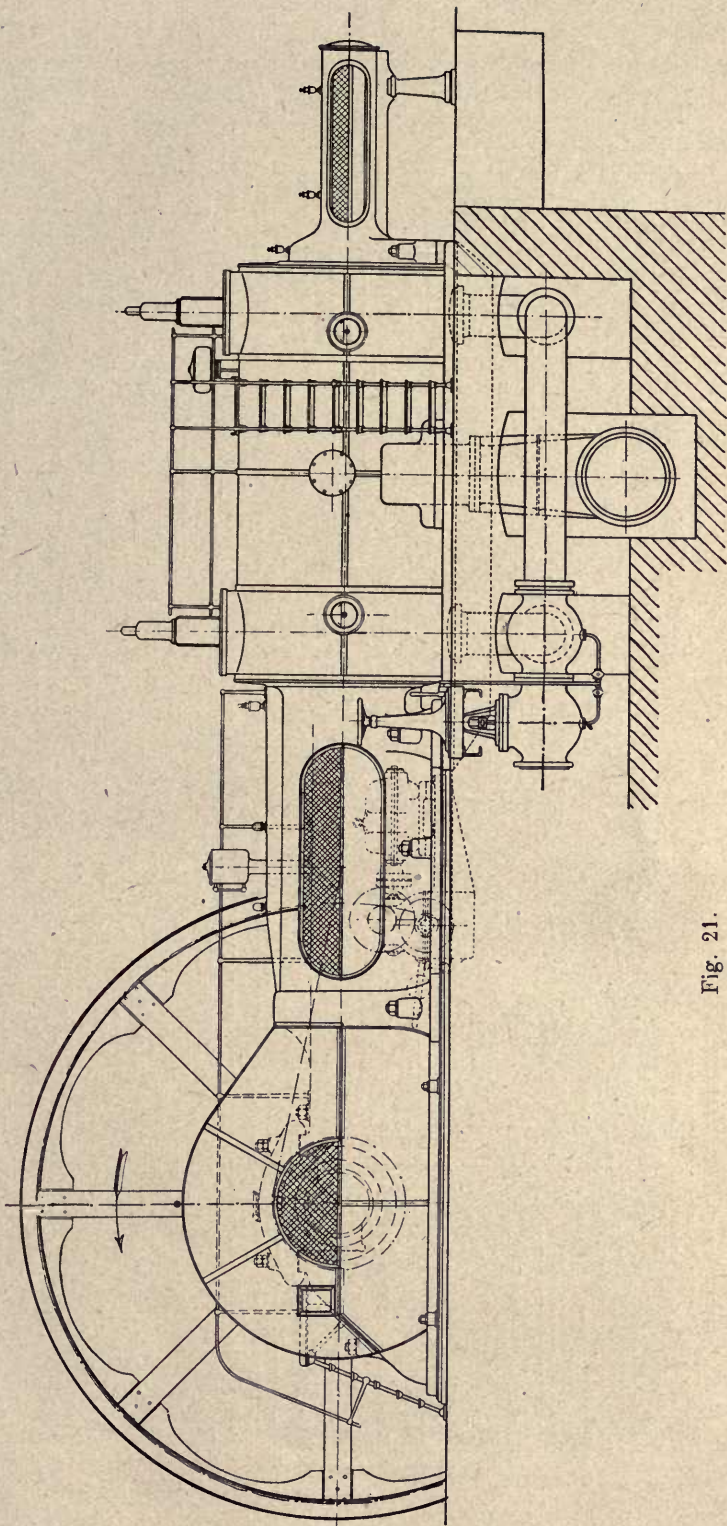


Fig. 21.

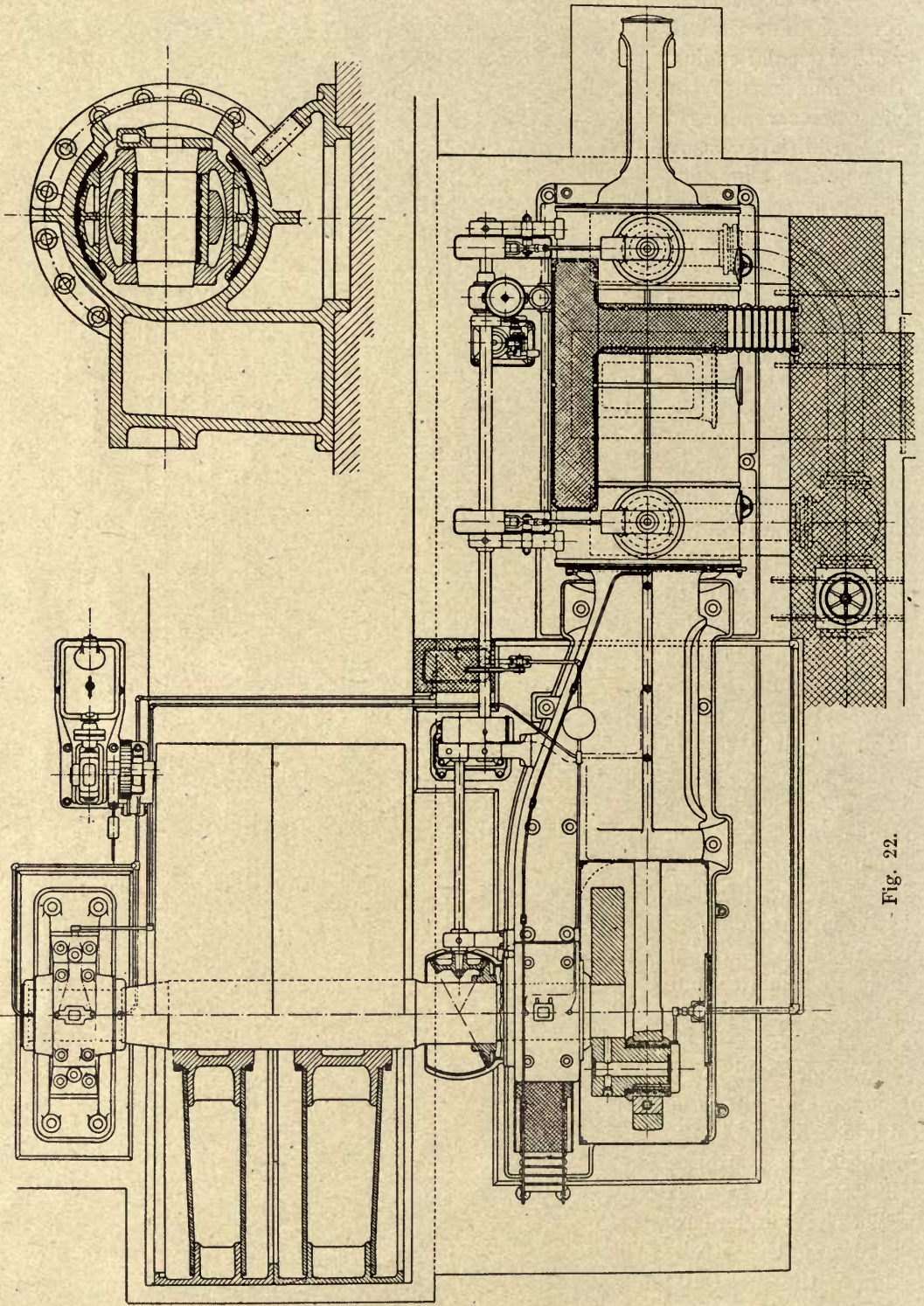


Fig. 22.

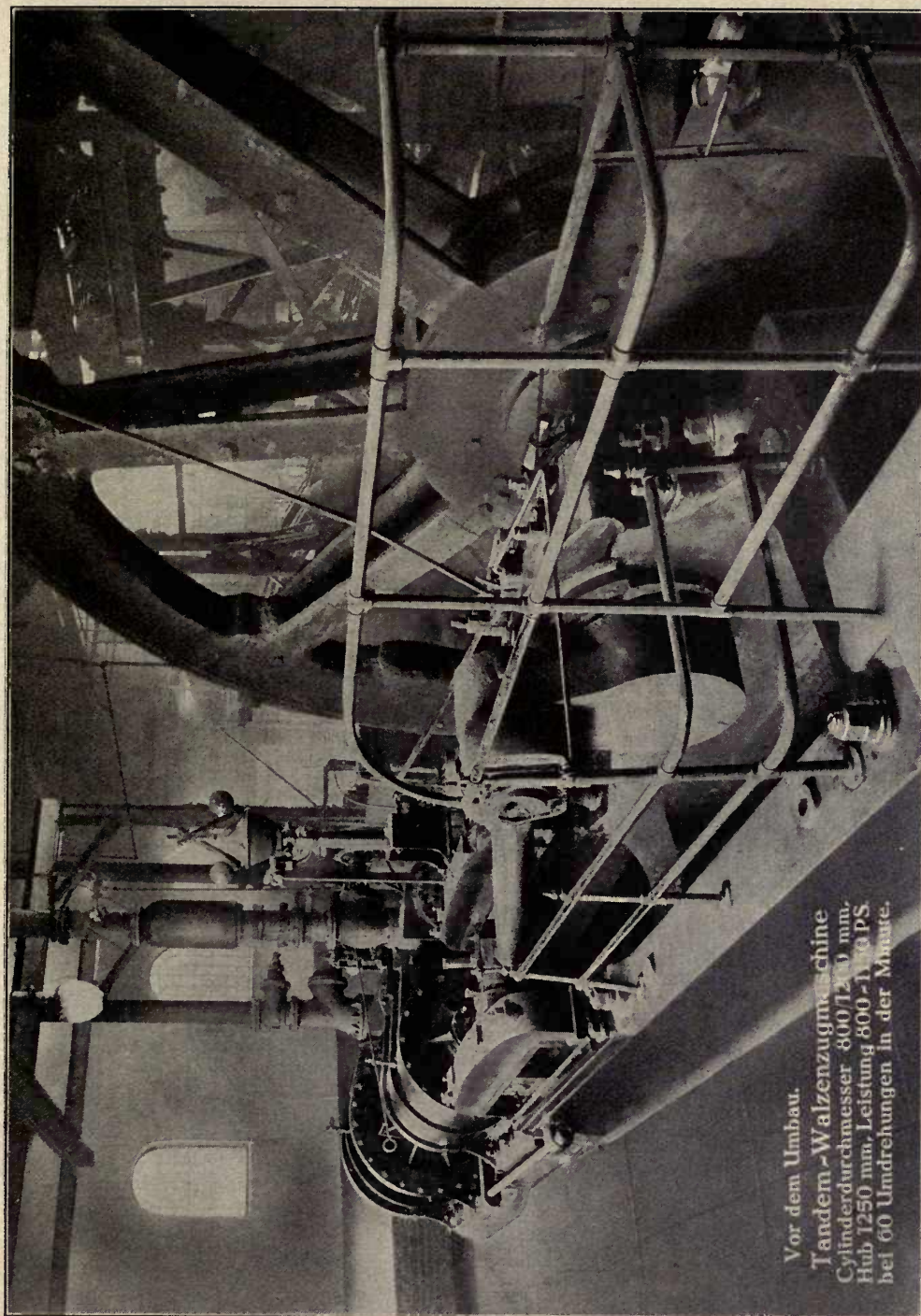


Fig. 23.

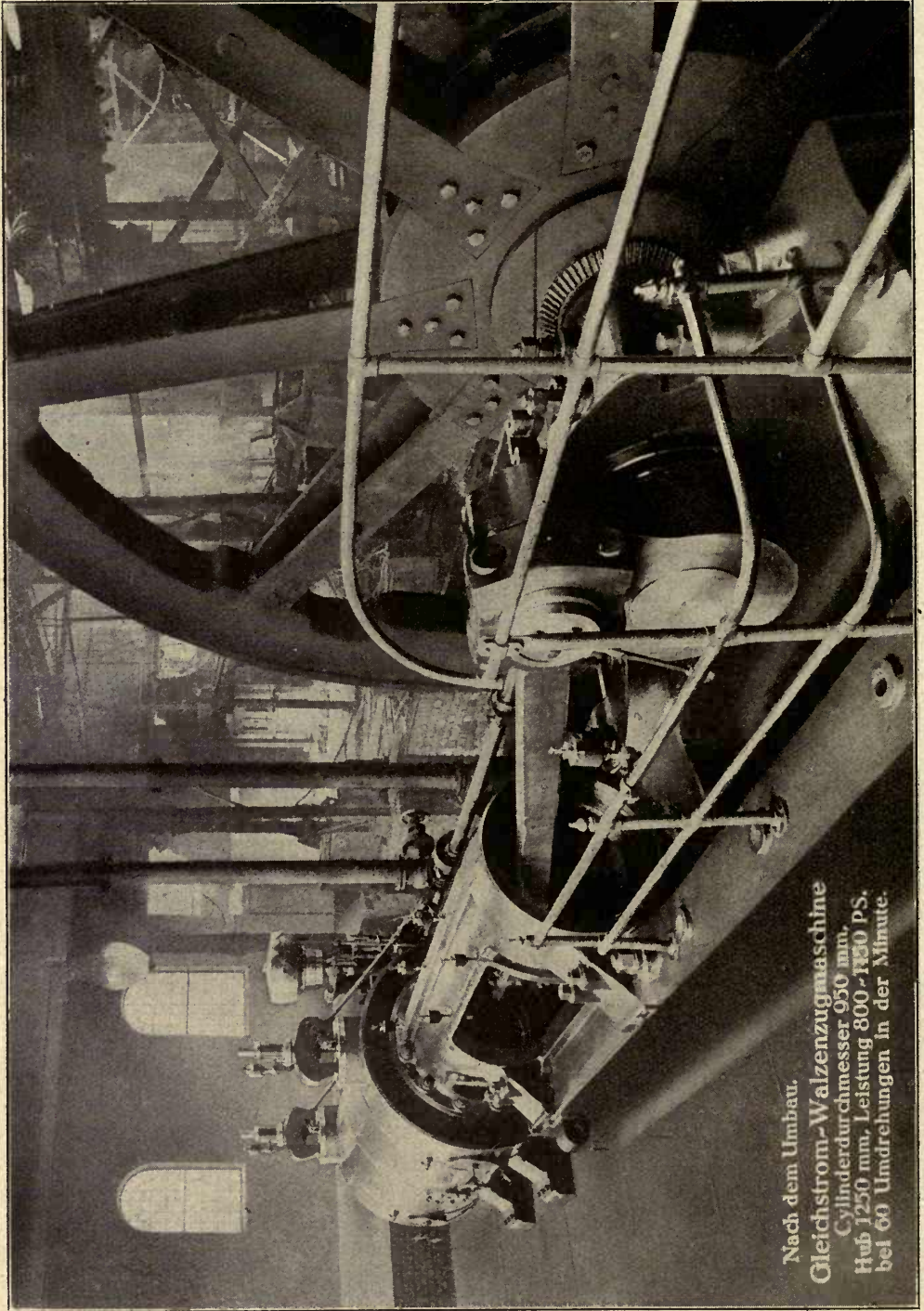


Fig. 24.

This engine has nearly the same dimensions of driving parts as the one just described. The diameter of the piston rod is 250 mm, that of the tail rod 225 mm, the crosshead pin is 400 mm diameter by 600 mm long, the crank pin 550 mm diameter by 600 mm long, and the main bearing 730 mm diameter by 1200 mm long. The use of a side crank in such a large engine of short stroke is noteworthy. In order to reduce the overhang, the crank and crank pin are of cast steel in one piece, with a hub length of only 450 mm (hub length : shaft = 0.62). The side crank construction, together with its corresponding type of frame, makes the engine simple and inexpensive. The same cannot perhaps be said of the Zvonicek valve gear employed on this engine, but it has the advantage of giving the late cut-offs essential for rolling mill engines, and of permitting the use of a standard governor which is in many cases preferred to a shaft governor on account of its simplicity and accessibility. The Zvonicek gear consists of a fixed eccentric, the strap of which

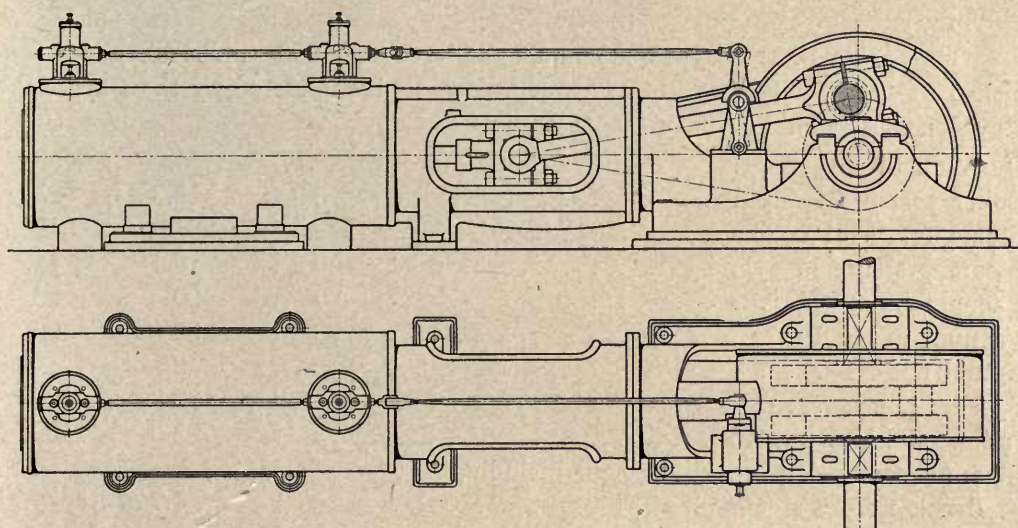


Fig. 25.

is provided with a cam profile and held at its armlike extension under the control of the governor. The combined motion of eccentric and cam is transmitted to the valve bonnet cam mechanism by a reach rod provided with a roller at its lower end.

Figs. 23 and 24 illustrate clearly the trend of development due to the una-flow engine and show the replacement of the two cylinders of an old tandem counterflow engine by a single una-flow cylinder. A number of such reconstructions have been carried out by Ehrhardt & Sehmer and other firms.

An engine built by Musgrave & Sons, Ltd. of Globe Iron Works, Bolton, England, is shown in Fig. 25. This firm is credited with the introduction of the una-flow engine on a large scale in Great Britain and colonies, the Stumpf valve gear being employed exclusively. A test carried out by Mr. F. Thomas on one of their engines, having a cylinder bore of 685.8 mm and a stroke of 914.4 mm gave the following results: Steam pressure 10.67 at. gage at the throttle, superheat  $10^{\circ}$ , speed 129 r. p. m., vacuum at the cylinder 66 cm, load 317 IHP, and steam consumption 4,98 kg/IHP-hour. The cylinder barrel was unjacketed.

Stork & Co., of Hengelo, Holland, also employ only the Stumpf gear on their engines, one of which is shown in Fig. 26. This firm has been very successful in introducing the una-flow engine in Holland and the Dutch colonies. Stork & Co. report that a test of one of their engines (650 mm bore by 900 mm stroke, speed 125 r. p. m.) showed a steam consumption of 4.86 kg/IHP-hour, the steam pressure being 8.24 at. gage, and the temperature 248°C. The cylinder barrel was unjacketed.

The type of una-flow engine built by the Maschinenfabrik Augsburg-Nürnberg is shown in Figs. 27 and 28. The inlet valves are placed horizontally and are operated by a rocking shaft and cam mechanism. This cam receives its motion from a short jack shaft which in turn is driven by the governor eccentric on the lay shaft. The clearance valve is situated opposite the steam valve and is arranged to act automatically in case of sudden failure of the vacuum. Partially or entirely unbalanced inlet and spring-loaded clearance valves may be made to serve the same purpose.

One engine of this type (903 mm cylinder bore, 1000 mm stroke) was furnished to J. P. Stieber, at Roth near Nürnberg and was tested by the Bayerische Revisionsverein on February 23, 1912.

Duration of test . . . . .	hours	4.17	4.05	8.06
Boiler pressure . . . . .	at. gage	13.3	13.3	13.2
Steam temp. at engine . . . . .		255	291	310
Steam pressure in cylinder . . . . .	at. gage	9.3	10.4	11.4
Vacuum in cylinder . . . . .	%	90	90	90
Vacuum in condenser . . . . .	%	93	92	92
Actual cut-off . . . . .	%	3	6	12
Speed . . . . .	r. p. m.	125.5	123.3	126.3
Indicated horse power. . . . .	HP	473	793	1109
Steam consumption in kg/IHP-hour including condensate from steam pipe . . . . .		4.69	4.74	4.71
Heat consumption in Cal/IHP-hour based on total heat of steam entering the engine . . . . .		3320	3440	3460
Thermal efficiency . . . . .	%	19	18.4	18.3

This engine was designed for a steam temperature of 330°C for which reason the cylinder barrel was left unjacketed. With jackets the steam consumption would in this case have been considerably lower on account of the beneficial effect of cylinder jackets for small cut-offs and low initial temperatures. On the other hand, the results once more demonstrate the small variation in steam consumption for large ranges of load (473 to 1109 HP) when no cylinder jackets are employed.

An engine built by the Görlitzer Maschinenbauanstalt is shown in Fig. 29. The cylinder has a bore of 1100 mm, a stroke of 1300 mm, and the engine runs at 91.6 r. p. m. The valve gear comprises a lay shaft with governor and shifting eccentric acting on short rocking shafts alongside the cylinder. The ends of the cylinder are jacketed. The air pump is driven from an extension of the tail rod.

Fig. 30 shows one of the latest engines built by this Company. There is only one governor eccentric, and the valves are operated through Lentz cam mechanisms from a rocking shaft on the cylinder, having two levers set at 180°. The air pump



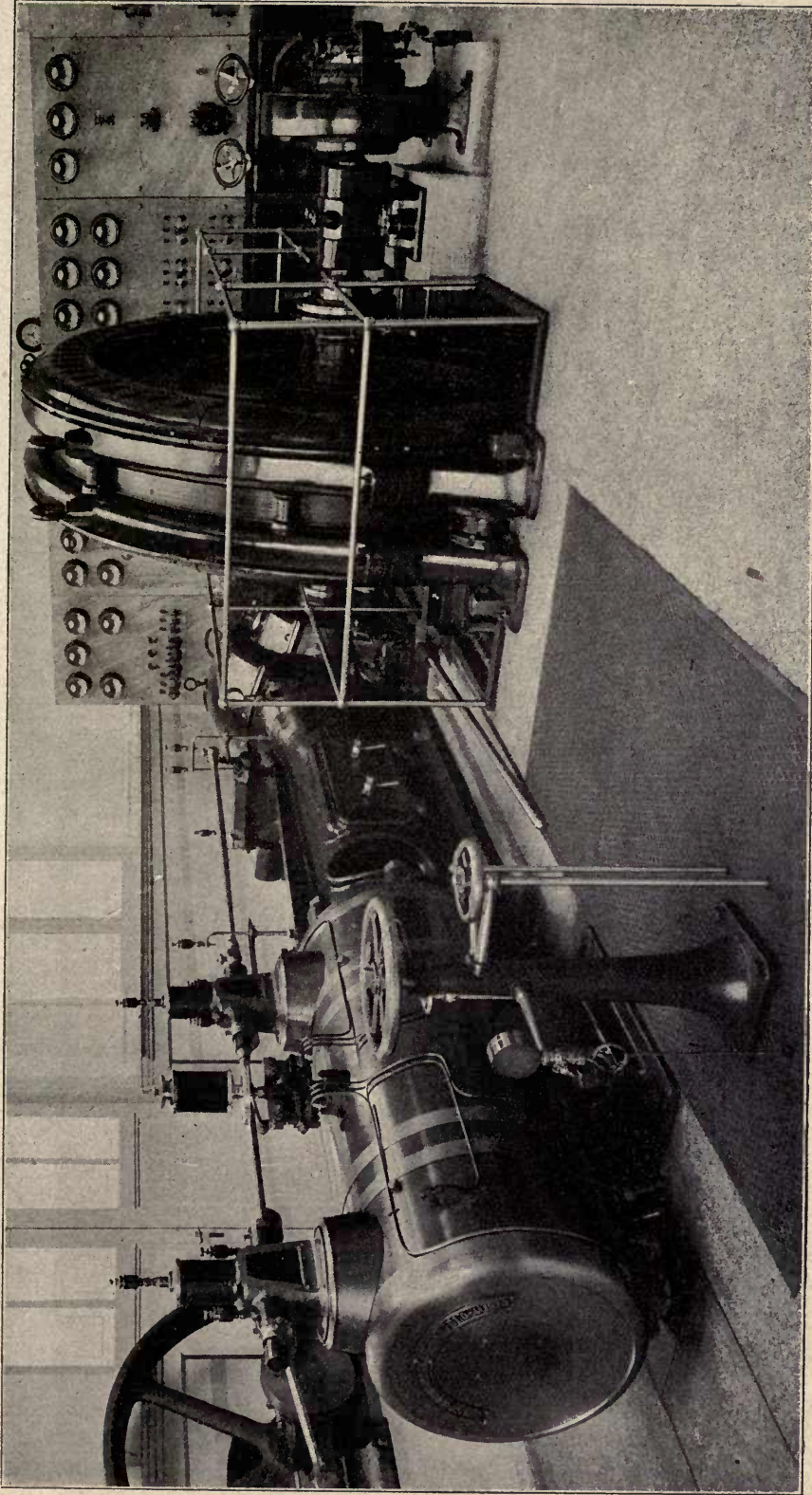


Fig. 26.

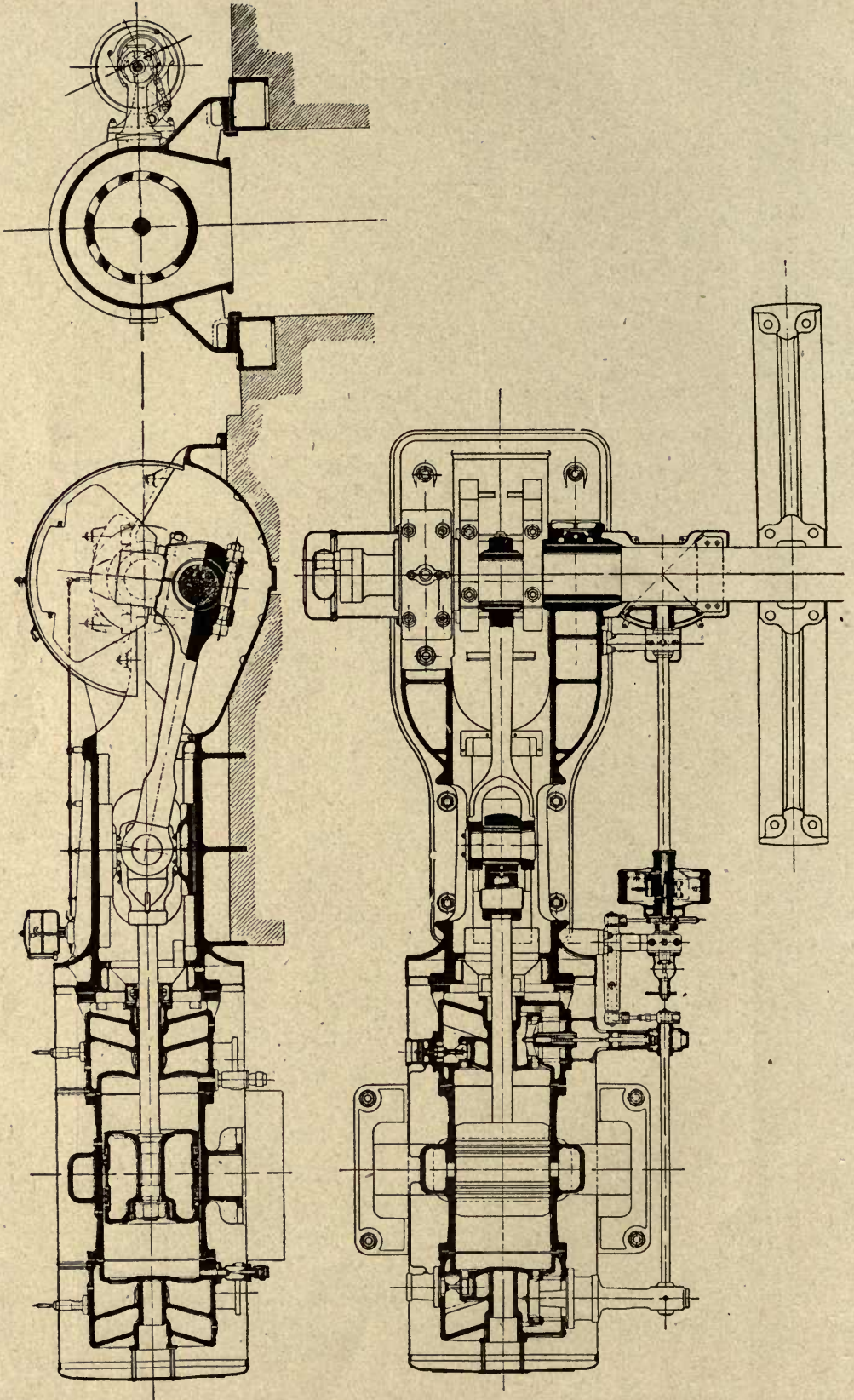


Fig. 27.

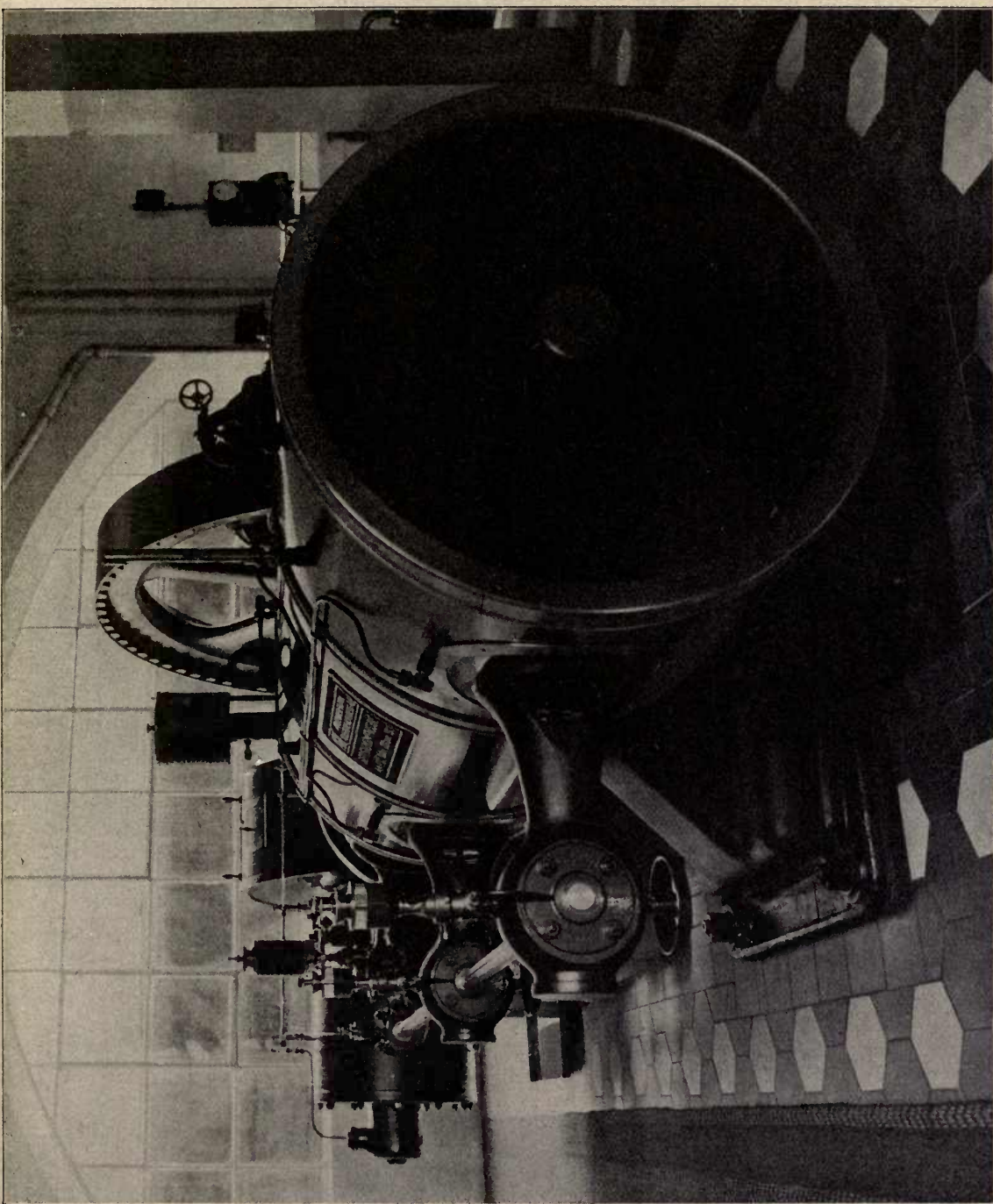


Fig. 28.

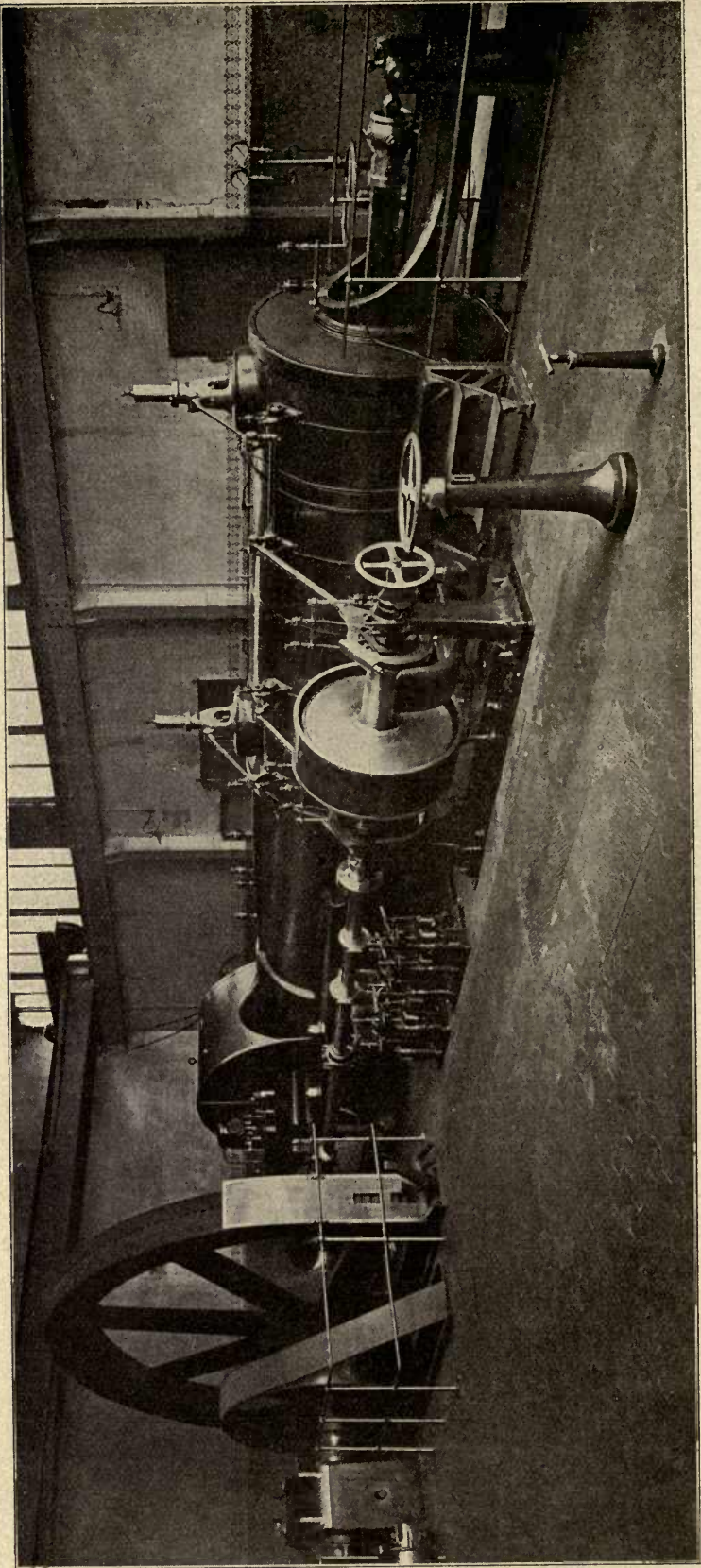


Fig. 29.

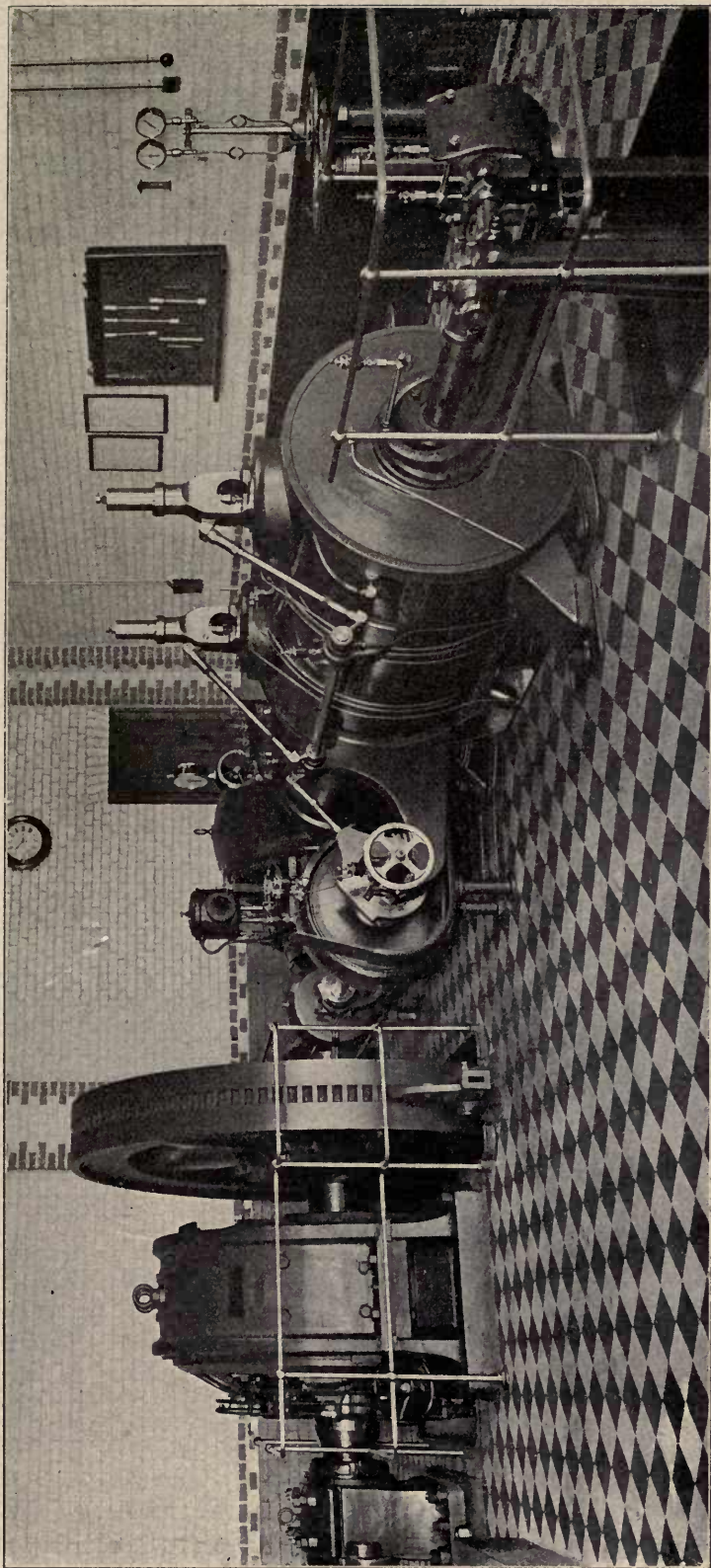


Fig. 30.

is again driven from the tail rod. In the single-eccentric type of valve gear the lay-shaft as well as the hole in the latter for the synchronizing device are shorter, and the governor may be placed close to the rear bearing. The basic idea of this gear is similar to the one used by the Maschinenfabrik Augsburg-Nürnberg. The single-eccentric gear is also described in the Z. d. V. d. I., 1914, No. 19, page 729. The valves are placed on the cylinder and consequently have somewhat larger clearance volume and surfaces. The jacketing is excellent; the arrangement of the condenser, however, is not free from objections. The firm reports the following steam consumption results.

Engine	Rated Load HP	Stroke mm	Bore mm	Steam Pressure at. gage	Mean Steam Temp. °C	r. p. m.	Steam Consumption kg/IHP-hr.	Measurements based on
1	550	1000	750	11.8	250	127.2	4.8	} Boiler feed water
2	810	1300	850	9.5	269.7	91.6	4.99	
3	300	800	650	11.7	253	15.67	4.88	
4	523	800	600	11.5	231	152	4.88	
5	140	600	375	9.7	340	200	4.38	

The steam temperatures in engines 1 and 5 were measured at the entrance to the cylinder head, and in engines 2, 3 and 4 in the middle of the same.

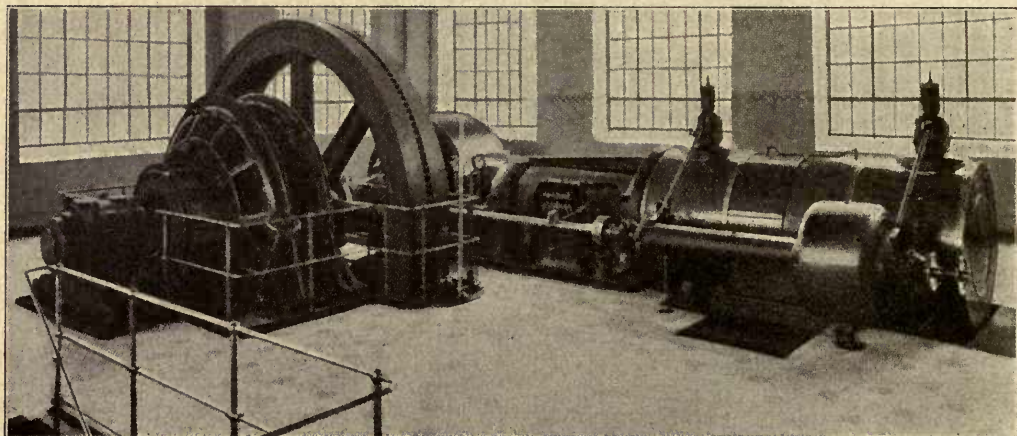


Fig. 31.

The greatest credit for the commercial introduction of the una-flow engine is due to Sulzer Bros., of Winterthur and Ludwigshafen. The cylinder of their first engine, which is in operation in the brass rolling mill of Wieland Bros., at Ulm, was designed by the author (Fig. 4, chap I, 1b, p. 10). The design of later engines was based on this first one, the only change being the substitution for the Stumpf gear of a lay-shaft gear, having two eccentrics which operate the valves by means of cams and roller levers pivoted in the valve bonnets (Fig. 31). The reciprocating roller slide of the Stumpf gear has therefore been replaced by the pivoted roller lever. The governor is placed close to the rear lay-shaft bearing

in order to reduce the deflection of the shaft and also to shorten the bore required for the synchronizing device. All of the driving parts, including those of the air pump in the basement, are completely enclosed. A gear pump on the lay-shaft supplies oil under a pressure of about 1 at. to the bearings of engine and air pump. The oil collects in a reservoir in the basement, where it is filtered and again enters the circulating system. Low oil consumption and smooth running due to the oil cushion in the bearings are advantages of this system. The consumption of cylinder oil is also low since only one cylinder and generally only one piston rod packing have to be lubricated, as against two cylinders and several packings in an ordinary multi-stage engine. The low oil consumption is also proved by the high mechanical efficiency. An engine furnished by Sulzer Bros. to the firm of Junker & Ruh, of Karlsruhe, having a cylinder bore of 675 mm, a stroke of 800 mm, and a speed

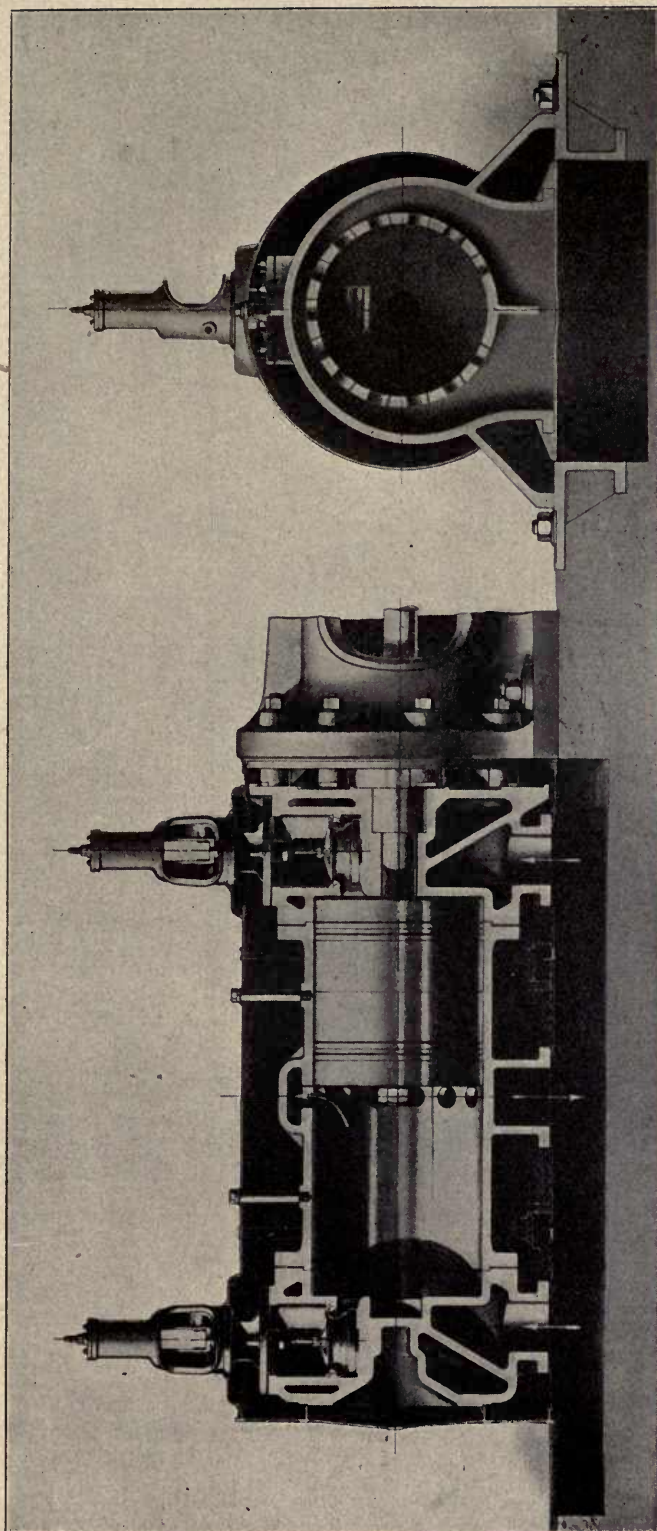


Fig. 32.

of 150 r. p. m., showed that for a steam pressure of 11 to 12 at. gage and a temperature of  $250^{\circ}$ , 12 to 18 kg of cylinder oil were consumed weekly, and 8 to 10 kg of bearing oil were added to the circulation when running 10 hours daily and six

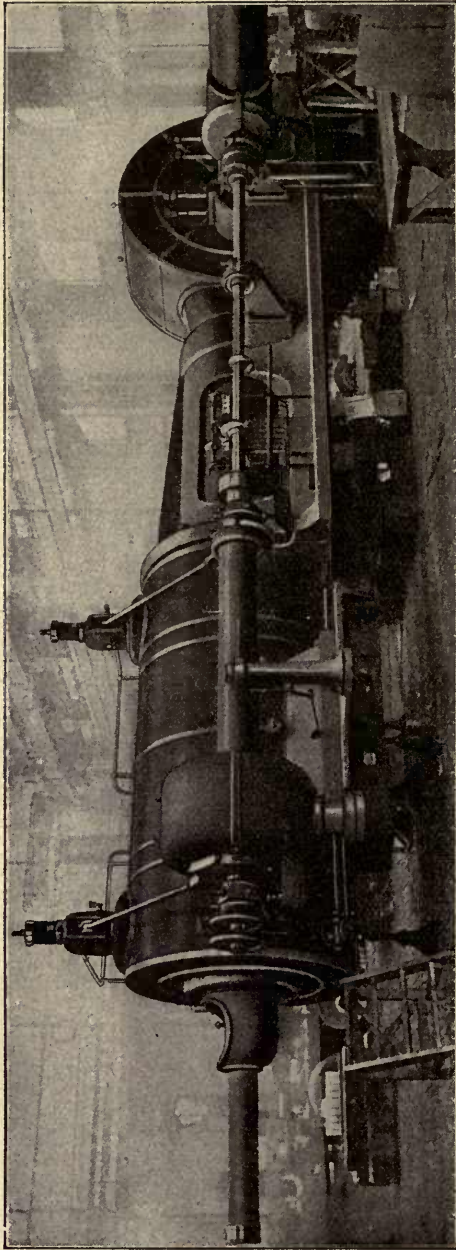


Fig. 33.

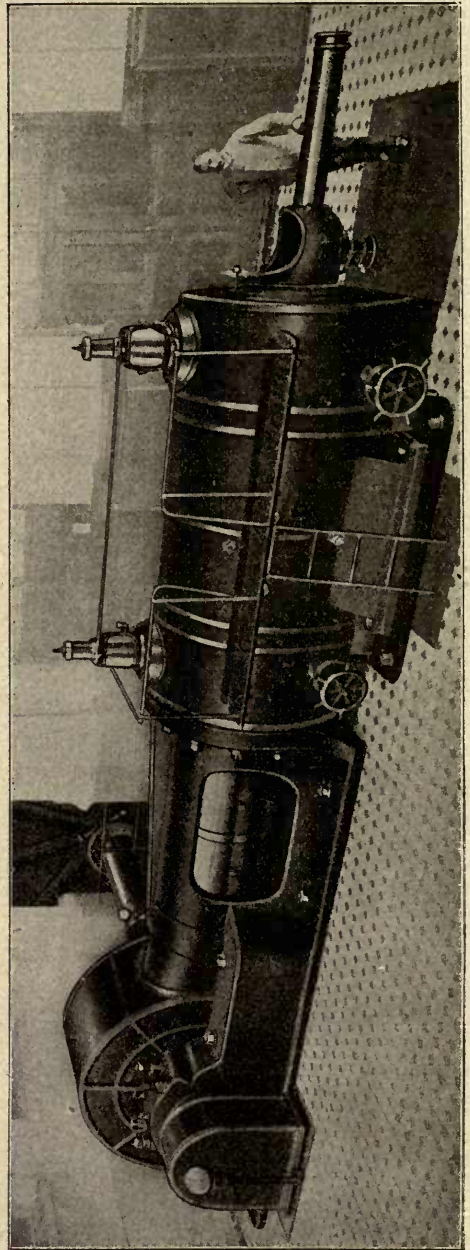


Fig. 34.

days per week. The whole of the oil in circulation, amounting to about 1 barrel, is replaced every 6 to 9 months. A hand pump is provided to supply the bearings with oil before starting. As shown in the sectional drawing Fig. 32, the cylinder design incorporates all the essentials previously mentioned. It is, however, to be



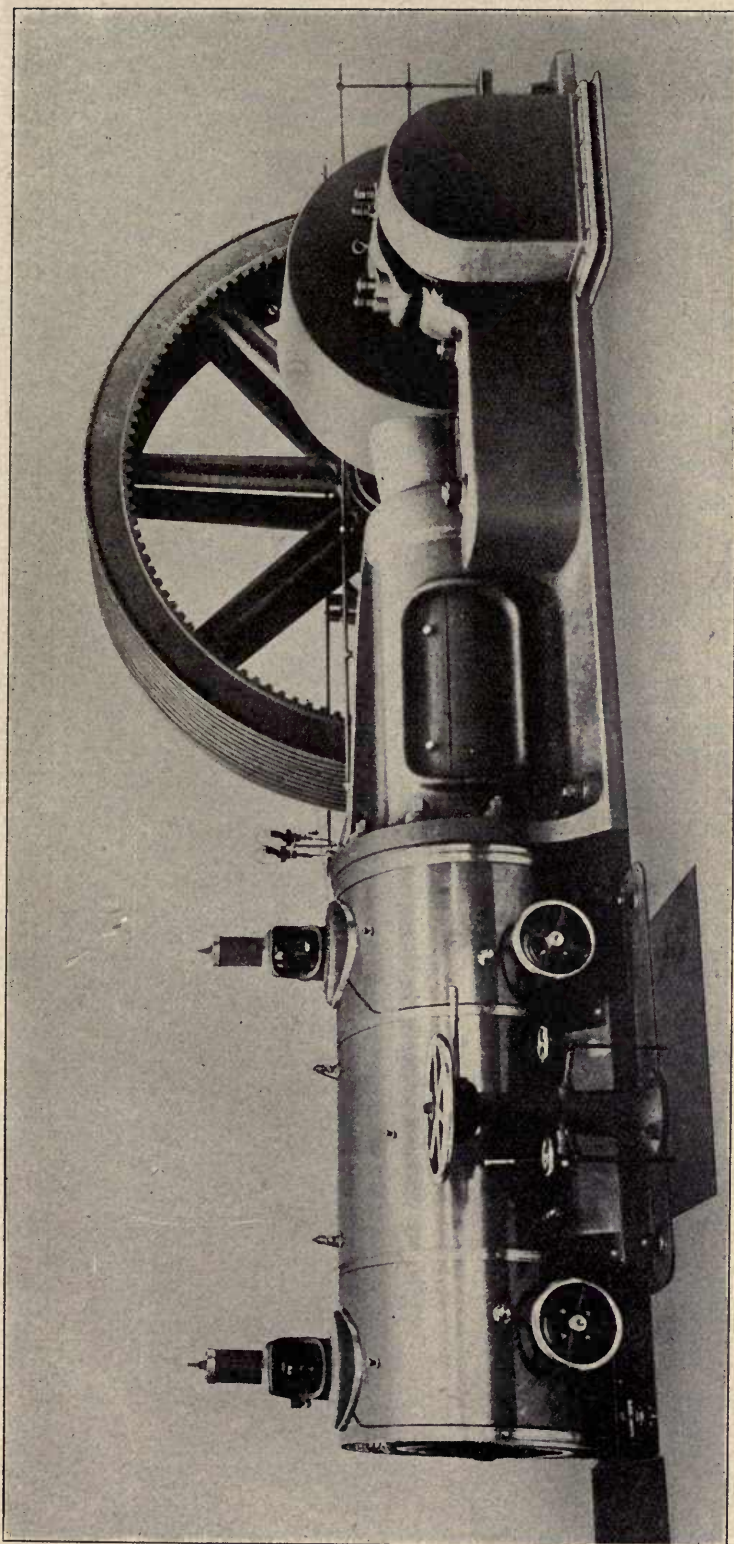


Fig. 35.

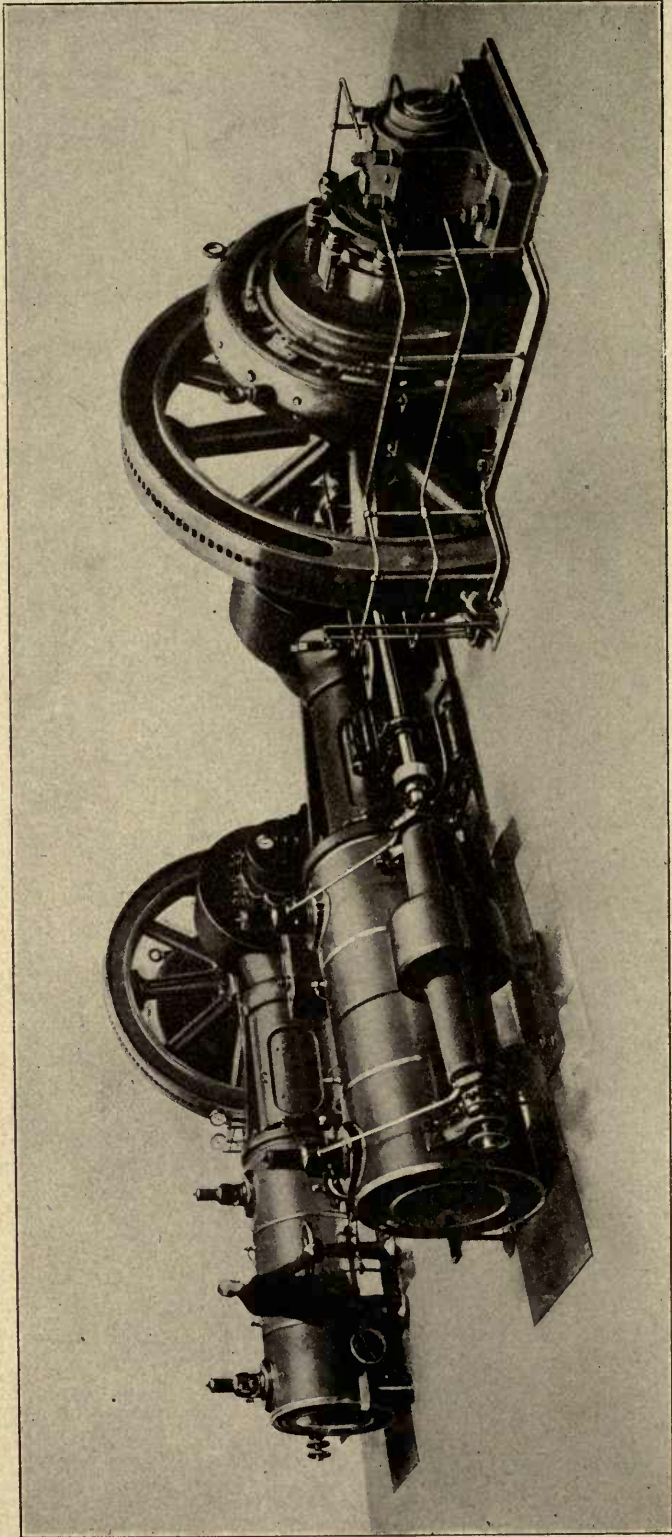


Fig. 36.

regretted that in many cases cylinder jackets are omitted when their use should be dictated by low steam temperatures.

Most of the engines built by Sulzer Bros. are fitted with a valve design the purpose of which could be otherwise accomplished simpler and better.

Extensive experiments have enabled Sulzer Bros. to find the proper mixtures for cylinder and piston castings, whereby reliable operation of these parts is insured without the use of a tail rod. The cylinders are bored barrel-shaped so that the cylinder surface becomes almost exactly cylindrical under operating conditions. To these precautions, in combination with a thoroughly reliable lubricating system, must be ascribed the fact that Sulzer Bros. have never had piston troubles. All of their una-flow engines have therefore been built with self-supporting pistons, except the engine shown in Figs. 33 and 34, supplied to the Crefeld Cotton Spinning Mill, and a series of engines supplied to the Badische Anilin- and Soda-Fabrik, where a tail rod was used to meet the purchaser's wishes.

A Sulzer stationary engine of standard design is shown in Fig. 35 (350 BHP at 150 r. p. m.), while Fig. 36 shows two Sulzer una-flow engines of 450 BHP each, supplied to the Hafod Copper Works, Swansea, South Wales.

The Maschinenfabrik Esslingen employs a particularly effective method of boring una-flow cylinders under temperature conditions closely approaching those of actual operation. The cylinder ends are heated to a high temperature by admitting live steam to the jackets, and the middle is cooled approximately to condenser temperature by a blast of air through the exhaust belt. The cylinder is then bored cylindrically, and the piston is turned smaller than the cylinder bore with a correct allowance, a difference of four thousandths of the diameter being usually sufficient. Since the piston expands more than the cylinder, and is of great length, ample bearing surface will be obtained. The piston heads should be turned somewhat smaller in order to allow for their greater expansion.

A piston as shown in Fig. 5, chap. I, 4, p. 77, fitted with bronze shoes, offers still greater safety against seizing, and this is true to a still greater degree of the floating piston having clearance all around.

Piston troubles are caused in many cases by a wrong method of supplying oil to the cylinder. The force pump should be timed in such a manner that delivery takes place only while the feed orifice in the cylinder is covered by the piston. A good distribution of oil to the piston and cylinder wall will then be obtained. The oil feeds should preferably be placed in the center of or close to the exhaust belt, where the cylinder has the lowest temperature. One feed should be arranged on the vertical center line and one each at either side in or below the horizontal plane, each feed being supplied by a separate plunger. Complaints which are sometimes made regarding the high oil consumption of una-flow engines frequently arise from defective methods of introducing the oil. It is fundamentally wrong to supply two or more feeds from the same pump plunger.

A neat arrangement of piping is obtainable if the steam pipes are placed on one side of the engine and the exhaust pipe, air pump, and the cooling water and discharge pipes on the other.

The following is a report of economy tests on the una-flow engine of the Crefeld Cotton Spinning Mill, built by Sulzer Bros.

Steam was generated by four Lancashire (twin furnace) boilers, having a total heating surface of 400 sqm. A fifth boiler, the steam and feed lines of which were blanked off from the others, supplied steam for heating purposes. The feed water

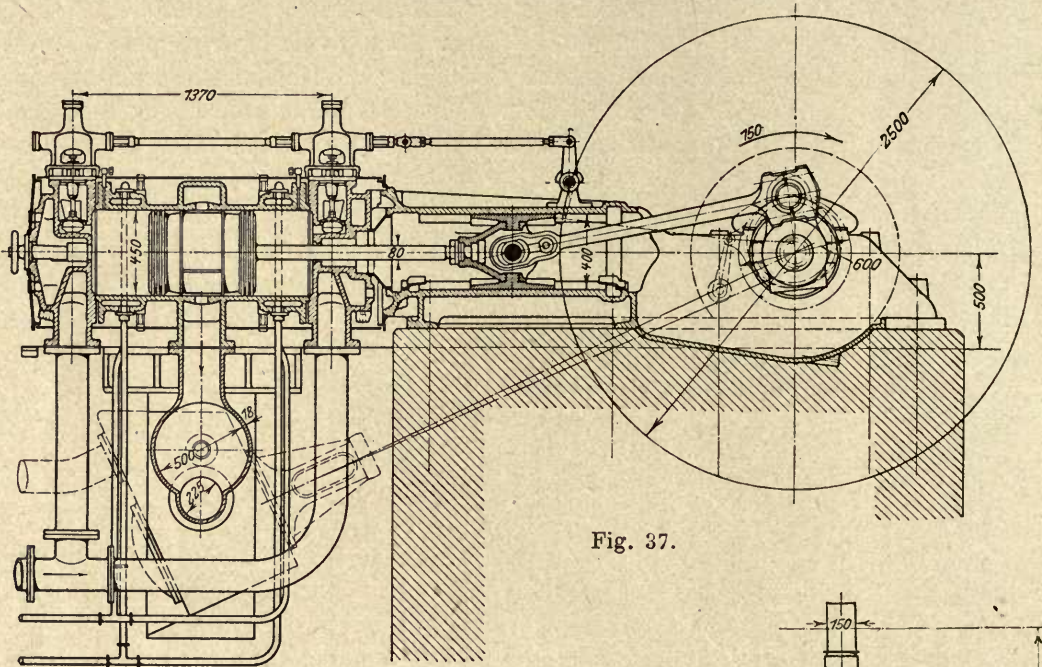


Fig. 37.

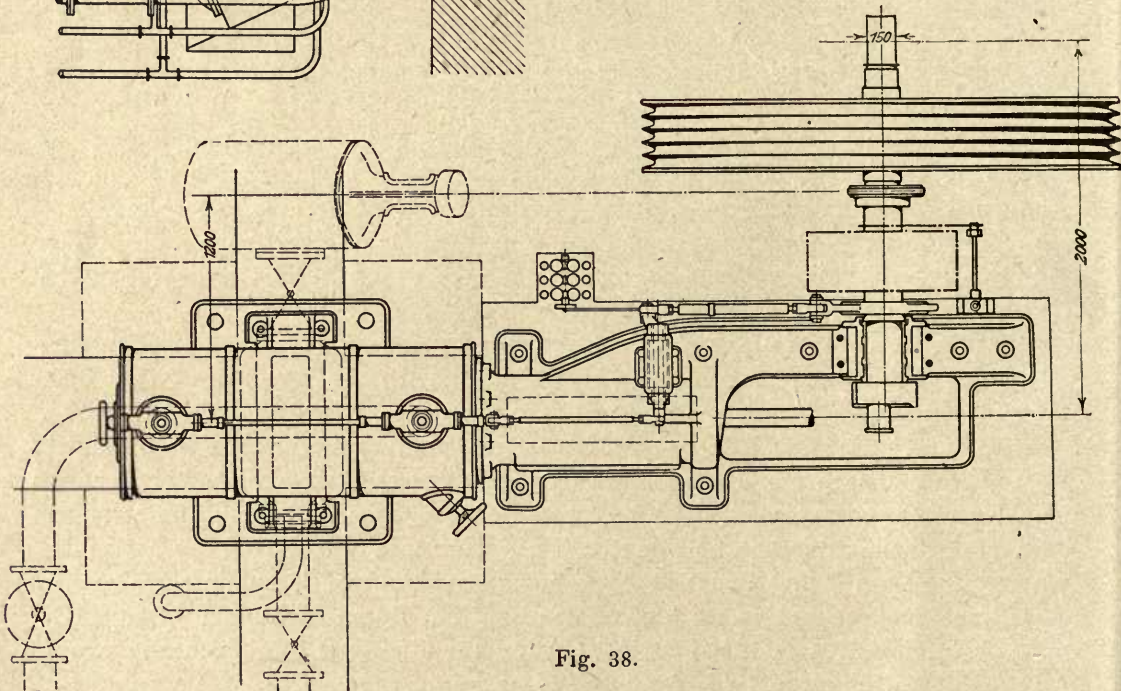


Fig. 38.

was weighed, transferred to a large tank and fed to the boilers by means of a centrifugal pump. Indicator cards were taken every 10 minutes, and the steam pressure, superheat and vacuum were recorded at the same intervals. The guarantees given for this engine were:

Maximum load 2340 IHP:

10% cut-off,	300°	temperature	1590	IHP	4.45	kg/IHP-hr
10%	350%	"	1530	"	4.15	"
13%	300°	"	1920	"	4.65	"
13%	350°	"	1860	"	4.35	"

These guarantees applied to steam of 11.5 at. gage pressure and condenser cooling water of 15° C.

The duration of the test was from 8 : 32 A. M. to 4 : 06 P. M. a total of 454 minutes.

The load varied from 1477 to 1752 IHP with an average of 1632.8 IHP at a speed of 109.5 r. p. m. Steam pressure at the cylinder was 11.1 to 12.1, average 11.6 at. gage; steam temperature at cylinder was 260 to 300°, average 282.6° C; vacuum was 71.3 to 73, 1cm, average 72.2 cm. Barometer reading 76.4 cm.

The temperature of the cooling water was 11.5° and that of the air pump discharge 30.1° C.

Since the load was higher than the guaranteed figure of 1590 HP, and the steam temperature less than 300°, a corresponding correction of the test results was necessary.

According to the guarantees, the steam consumption increases from 4.45 kg to 4.65 kg or 0.2 kg for an increase of load from 1590 to 1920 HP, or 330 HP; therefore for an increase in load of  $1632.8 - 1590 = 42.8$  HP, the permissible increase may be  $\frac{0.2 \cdot 42.8}{330} = 0.026$  kg and the steam consumption may be  $4.45 + 0.026 = 4.476$  kg, and still be within the guarantee.

Tests have shown that a reduction of the initial temperature from 300° to 282.6° produces an increase in steam consumption of 3%.

The permissible steam consumption may therefore be  $4.476 \times 1.03 = 4.61$  kg, and yet be within the guarantee.

The total steam consumption was 56410 kg, or

$$\frac{56410 \cdot 60}{454} = 7455.06 \text{ kg/hour}$$

or

$$\frac{7455.06}{1632.8} = 4.56 \text{ kg/IHP-hour.}$$

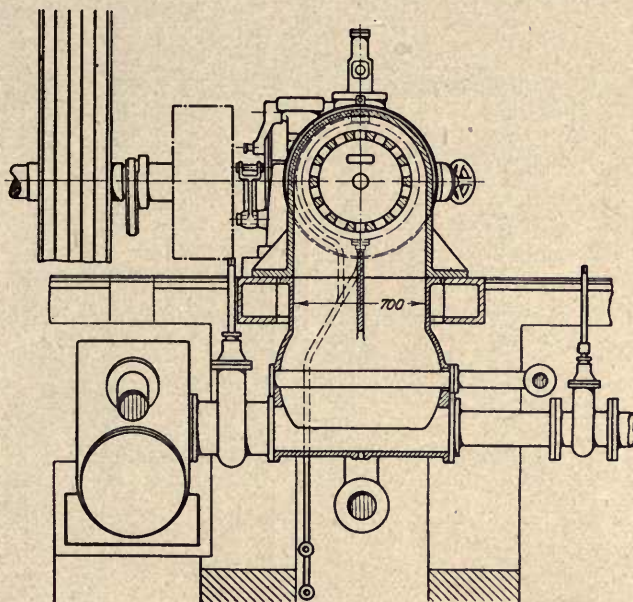
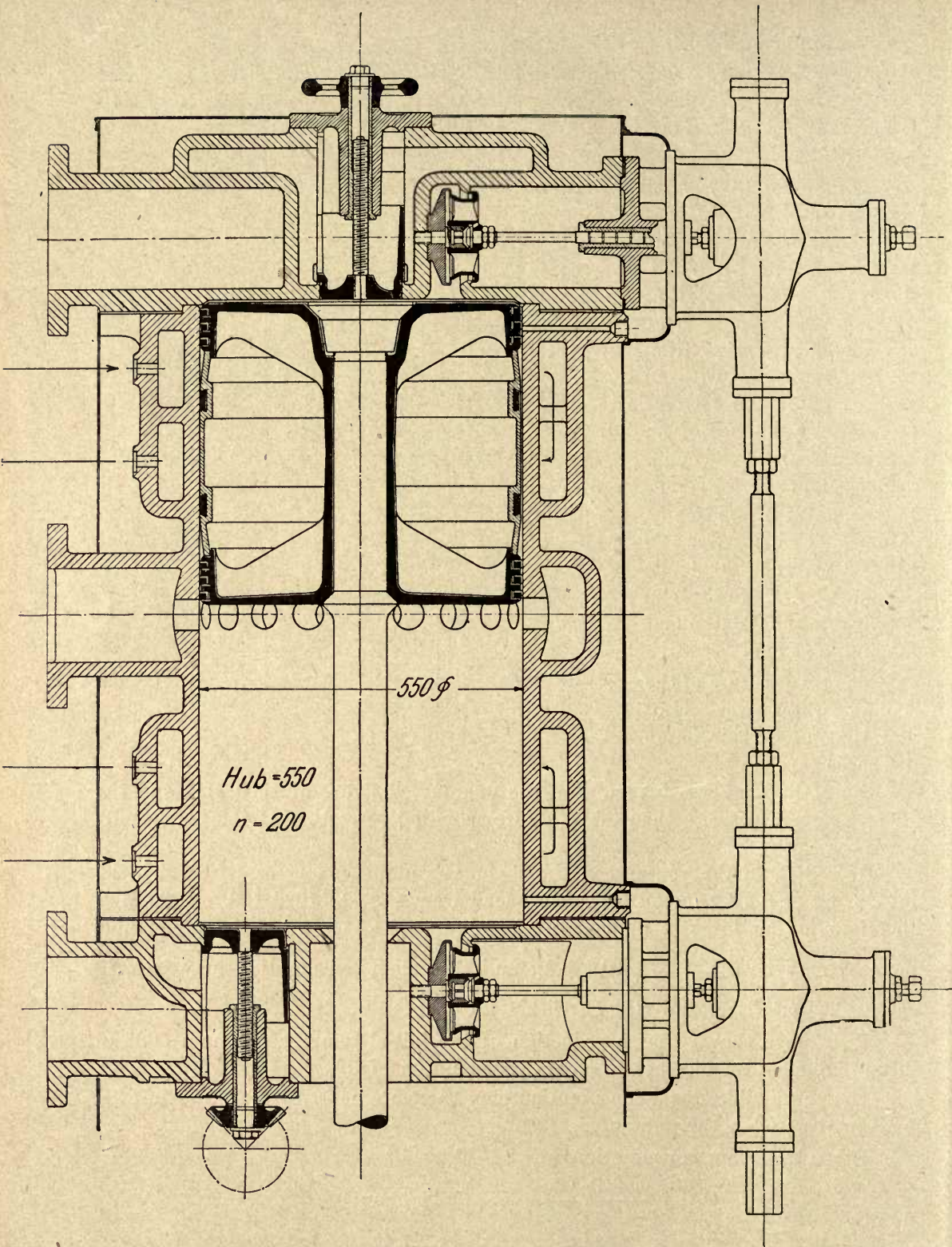


Fig. 39.



The guaranteed figure was therefore satisfied without taking advantage of the permitted allowance of 5%.

The above report was made by the Association for the Inspection of Steam Boilers, of München-Gladbach, Crefeld Branch Office, on October 4, 1913, and signed by Mr. Rhenius.

In examining this result it must be borne in mind that the cylinder barrel of this engine was not jacketed.

A una-flow engine designed by the author for the Soumy Machine Works is shown in Figs. 37 to 39. It has valve gear of the Stumpf type and is designed to be used with saturated steam of 7 at. gage. The cylinder has a bore and stroke of 450 and 600 mm respectively, and the speed is 150 r. p. m. The resilient inlet

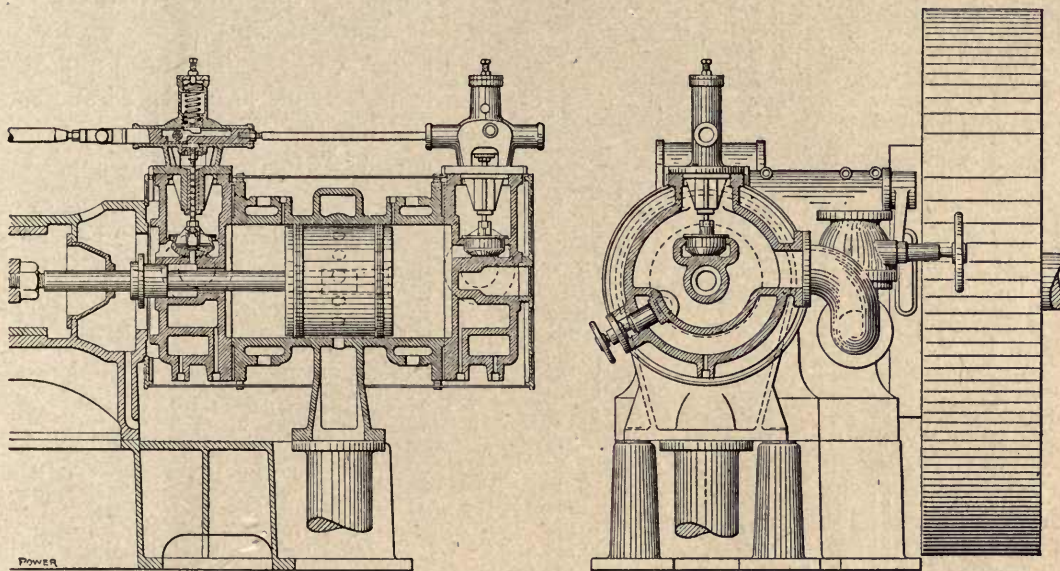


Fig. 41.

valves and the clearance valves are designed and arranged in such a manner that the total clearance volume amounts to only 1.24% for a linear piston clearance of 3 mm. The nut is flush with the piston so as to avoid the clearance volume of about 0.5% resulting from a projecting nut. The two-piece cast steel self-supporting piston is fitted with a bronze shoe fastened to it with copper rivets; the rest of the piston has several millimeters clearance all over. Each half carries three somewhat narrow rings, none of which overruns the cylinder bore. The harmful surfaces are small, and are jacketed and machined in addition. The ends of the cylinder are provided with jackets since saturated steam is used. The suction of the air pump takes place through ports, and the discharge valves are arranged in the heads, so that the clearance is small and the suction effect a maximum. The condenser is placed immediately under the cylinder with a connection of large area.

The cylinder jackets are supplied with steam through a separate pipe connected to the steam main ahead of the stop valve. This allows the cylinder to

be warmed up before starting, and the valve gear therefore gives correct distribution from the very beginning. The eccentric rod is shortened and guided by a swinging link interposed in the valve gear, thus compensating the angularity of the connecting rod. This equalization of cut-offs and valve lifts at the two cylinder ends is very complete for all cut-offs, which range from 0 to 25%.

Fig. 40 shows another similar engine with Stumpf gear designed by the author for a company in Finland. The lower seats, instead of the valves, are resilient,

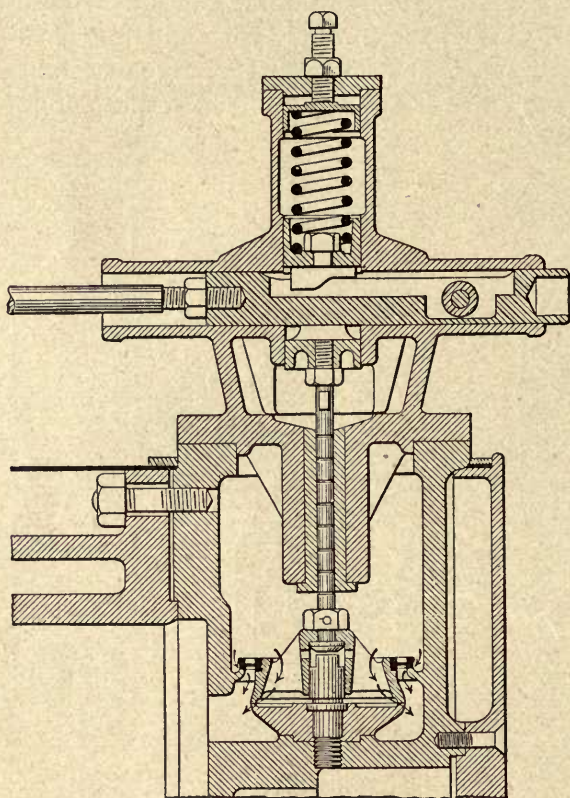


Fig. 42.

and the piston is fitted with Allan metal rings to prevent seizing. The clearance volume is 1,25%.

Details of una-flow engines built by the Ames Iron Works, of Oswego, N. Y., are given in Figs. 41 to 44. The head and the cylinder ends are jacketed and the additional clearance spaces are arranged in the cylinder heads. The upper resilient seat of the valves is made of steel and shrunk in place on the cast iron valve body. For non-condensing service the engine is fitted with a piston having cupped ends and the length of compression is 90%.

The following test results were verified by Mr. F. R. Low, editor of "Power" (S. page 160).

In Fig. 45 is shown a small vertical una-flow engine of 30 HP at 400 r. p. m. for marine lighting service.

A better design is shown in Fig. 46, illustrating a similar engine of 30 HP designed by the author for an English firm. The cylinder bore is 220 mm, the stroke 160 mm, and the speed 400 r. p. m. The governor eccentric oscillates a roller lever acting on a triangular cam which transmits the motion to the valves. The whole cam mechanism is enclosed in a separate housing filled with oil. The cylinder ends are jacketed, and the additional clearance pockets are formed in the cylinder heads and arranged to be heated by live steam when operating condensing. The perfect tightness of the single-beat valves employed, the small clearance space and clearance surfaces, the generous jacketing, and the ample exhaust port area all combine with the una-flow action to insure high economy. The single-beat valves provide absolute safety against damage from water which may be trapped in the cylinder.

The design of the two cylinder vertical single-acting stationary engine shown in Fig. 47 is worthy of notice. The inlet valves are single-beat and are placed in



the center of the cylinder heads. The valve gear consists of a cam mechanism with reciprocating slides operated through a bell crank by an eccentric and shaft governor located at the free end of the crank shaft. The cranks are set at 180° in order to obtain proper balance at the high speed at which this engine is to run. Single-beat valves are permissible because the high compression balances the pressure against which they open. The valve gear parts may, however, be easily made strong enough to withstand the load if the valve should be lifted when there is no compression to balance the

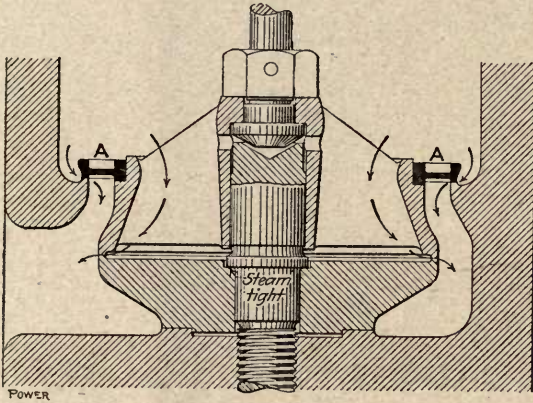


Fig. 43.

pressure upon it. The cylinder head proper is a thin dished steel plate, and the cylinder is provided with a forged steel liner. The cylinder head is jacketed and the upper end of the cylinder is also heated by live steam admitted to a number of turned grooves. Each groove communicates with the adjacent ones at opposite sides so that a continuous flow may take place through the grooves. The engine is intended for use with saturated steam, for which reason the unjacketed part of the cylinder next to the exhaust belt is short. The forged steel cylinder liner should be made of hard material in order to insure satisfactory service of the cast iron piston rings. The top surface of the piston is arched to

Test results of a 15" X 16" Stumpf Una-flow Engine built by Ames Iron Works, Oswego N. Y.

Date . . . . .	October 5, 1914						June 6, 1914						September 5, 1914					
	Non-condensing Saturated steam			Non-condensing Superheated steam			Non-condensing Superheated steam			Condensing Superheated steam								
Test No. . . . .	I	II	III	IV	I	II	III	IV	V	I	II	III	IV	V	VI			
Load . . . . .	1/4	1/2	3/4	1	0	1/4	1/2	3/4	0.85	0	1/4	1/2	3/4	1	1 1/2			
Steam pressure kg/sqcm gage . . . . .	10.3	10.2	10.2	10.3	9.7	9.85	9.85	9.85	9.64	10.36	10.2	10.2	10.2	9.85	9.85			
Speed . . . . . r. p. m.	257	256	255	254	262	258	255	253	252	—	53	49	52	239	260			
Superheat . . . . . °C	—	—	—	—	73	65	72	66	63	28	—	—	—	—	78			
Steam temperature . . . . . °C	184.3	183.6	183.6	184.3	255	247	254	248	245	212	237	232	235	232	260			
Vacuum . . . . . cm Hg	—	—	—	—	—	—	—	—	—	66	66	64.8	64.8	63.6	61			
Load on generator . . . . .	100	200	300	400	—	100	200	300	350	—	100	200	300	400	600			
Indicated HP . . . . .	56.2	94.8	132.6	174	13.1	57	93.8	135.8	154.5	11.65	53.7	94.2	132.8	178	261			
Steam consumption kg/HP-hour . . . . .	9.4	9.12	9.32	9.53	8.05	7.74	7.52	7.61	7.74	6.72	5.91	5.59	5.59	5.78	6.85			

Stumpf, The una-flow steam engine.

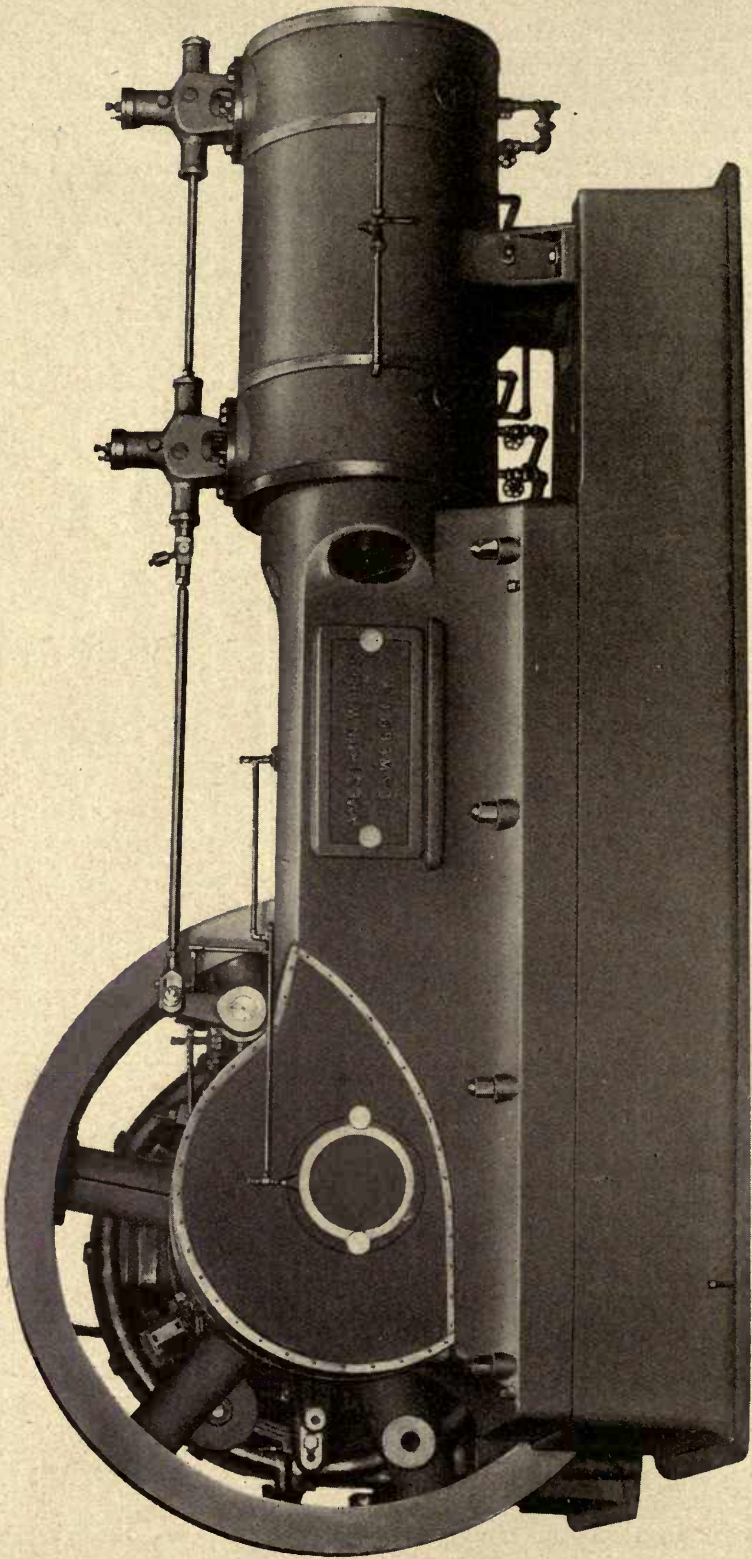


Fig. 44.

provide sufficient strength with a light section. The small thickness of cylinder head and cylinder liner is intended to bring the temperature of the harmful surfaces as close as possible to that of the live steam, in order to reduce their temperature variation. This design allows the additional harmful surface to be reduced

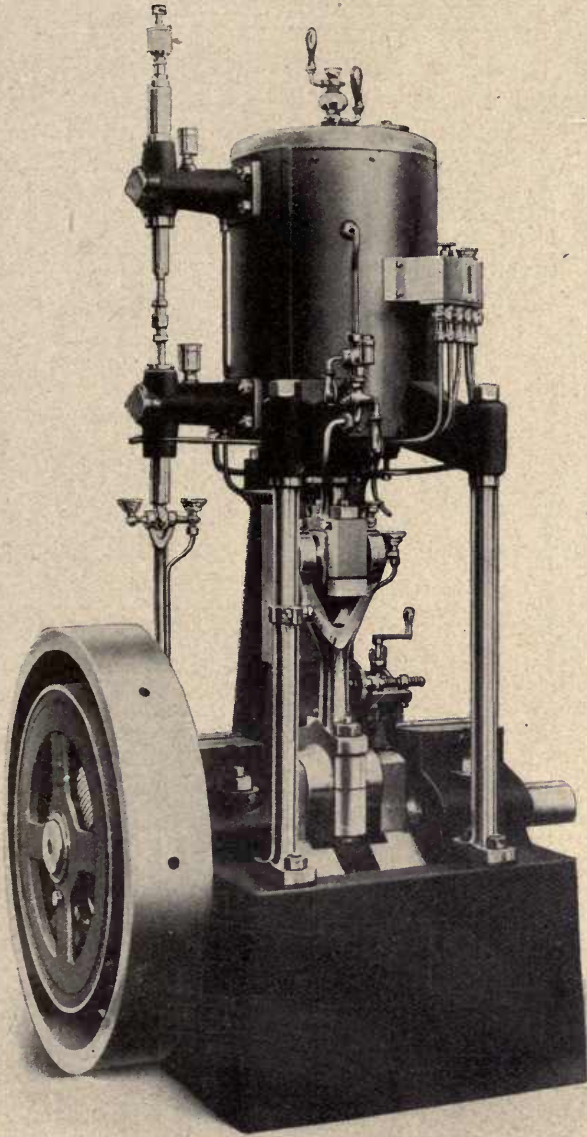


Fig. 45.

to as small an amount as 8%. The flow of steam through this cylinder takes place in such a perfect manner as cannot be attained by any other cylinder design. The steam enters centrally at the top, spreads out in all directions in the narrow space between cylinder head and piston, and leaves in a similarly even manner at the

bottom of the cylinder. The water of condensation collects on the piston surface during the outstroke and is completely removed by the rush of exhausting steam,

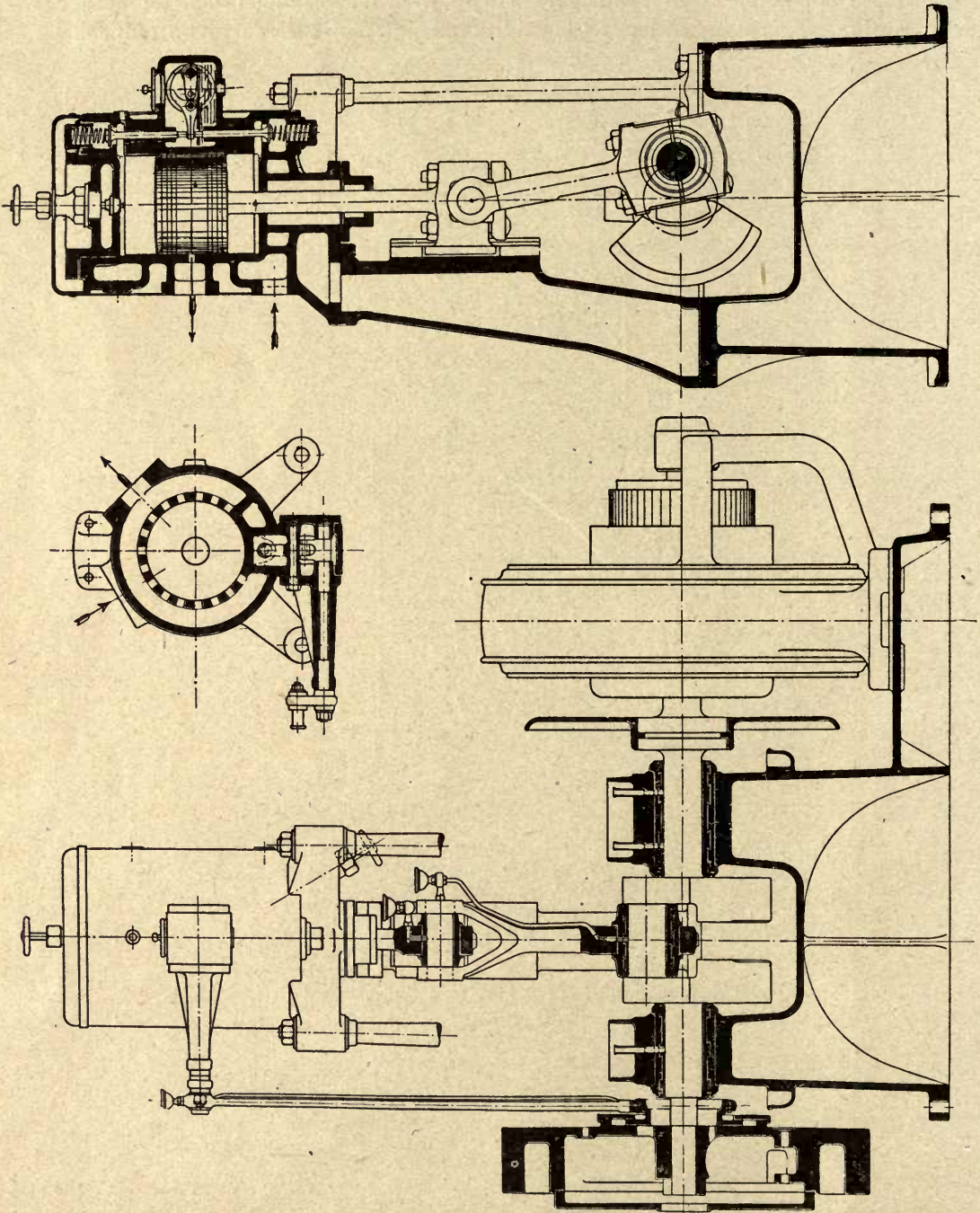


Fig. 46.

this action being assisted by the arched form of the piston head. The un-a-flow principle, together with the very favorable flow conditions, the thorough draining of the cylinder at each stroke, the ample jacketing, the perfect tightness of the

inlet valve, the small clearance volume and surfaces will insure a very low steam consumption with this type of engine.

Proper attention must be paid to the design of the lower part of the piston which forms a seal against vacuum.

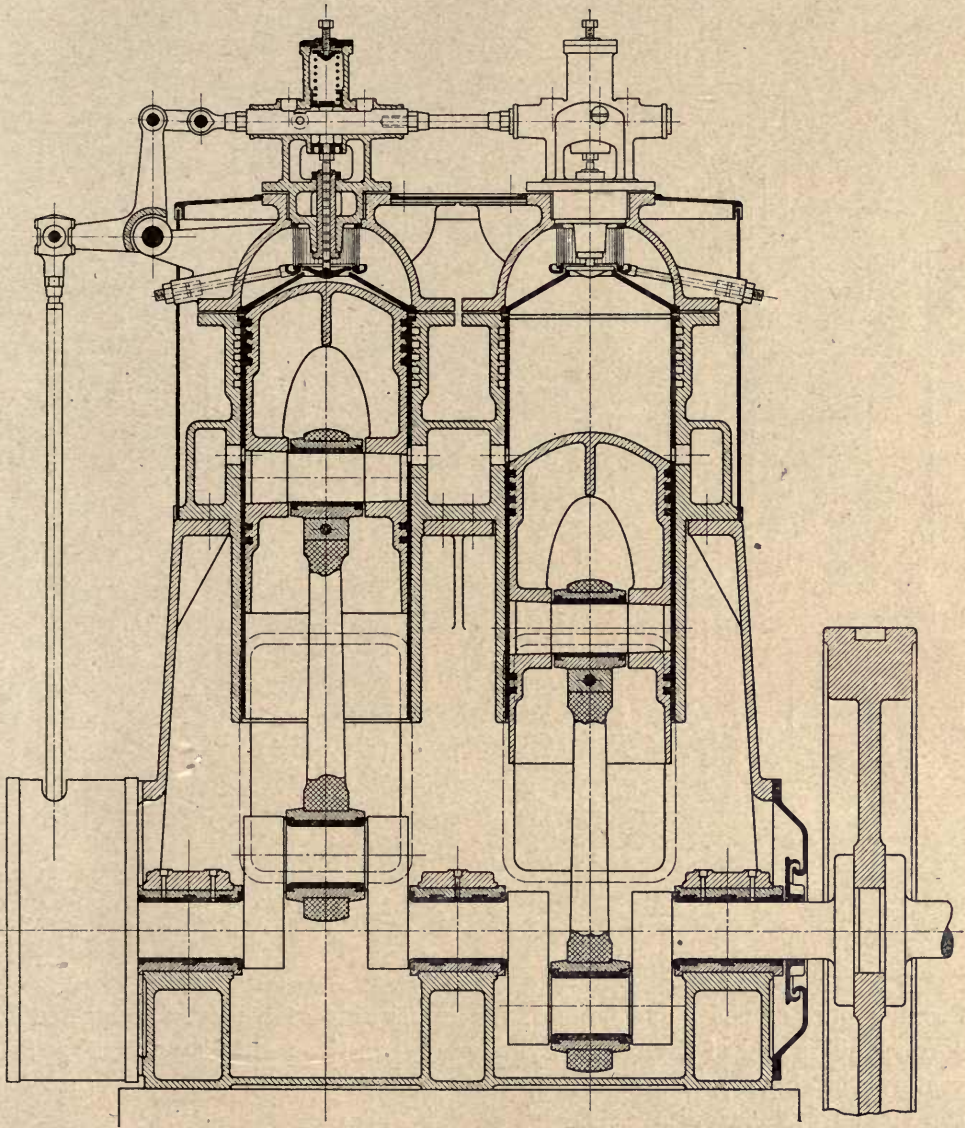


Fig. 47.

Fig. 48 shows an interesting cylinder design with automatic auxiliary exhaust valves. (See also chapters on withdrawal of steam and on locomobiles.) This engine is a una-flow engine in a restricted sense only, since at light loads the exhaust steam leaves through the valves only, while for longer cut-offs part of it exhausts also through the ports. The ports in the cylinder leading to the auxiliary exhaust valves are overrun by the piston, thus determining the compression. The auxiliary

exhaust valves in this design are operated automatically by the working steam of the cylinder; they may, however, be opened and closed by a separate valve motion. On the stem of each exhaust valve is mounted a piston working in a cylinder

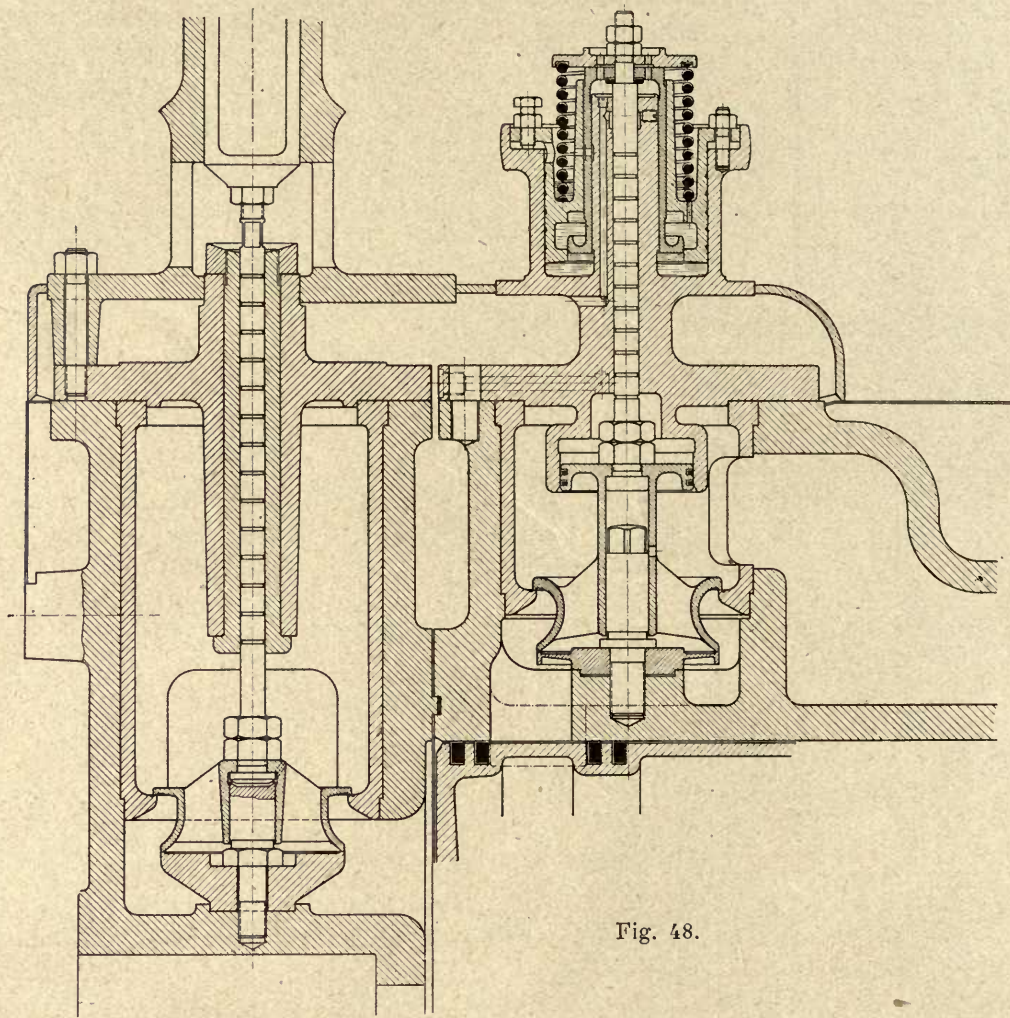


Fig. 48.

forming part of the valve bonnet, the upper side of which is connected to the corresponding end of the engine cylinder. When the main piston is near the dead center, the high pressure in the engine cylinder also acts on the piston attached to the auxiliary exhaust valve and thus holds the latter closed until the main exhaust ports are uncovered and the pressure is released. The spring on the upper end of the stem then opens the valve and holds it

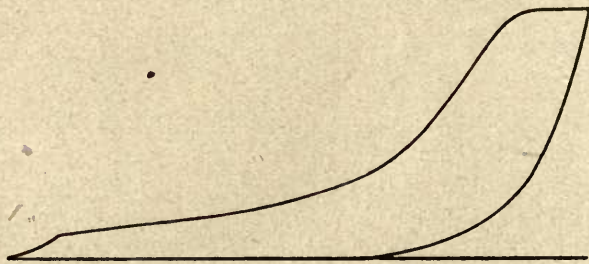


Fig. 49.

open until at the end of the stroke the steam pressure rises sufficiently to close it. Exhaust therefore takes place through the valves until the piston overruns the auxiliary exhaust ports. The clearance space in this design is not larger than that of an ordinary condensing engine, and the length of compression can be chosen to suit any required conditions. The volume loss will be considerably reduced, although there will

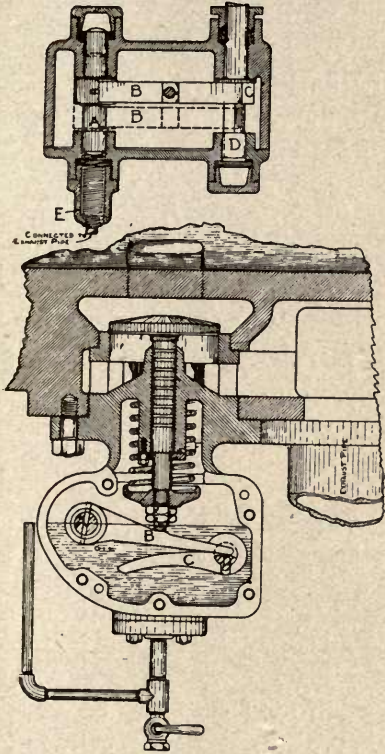


Fig. 50.

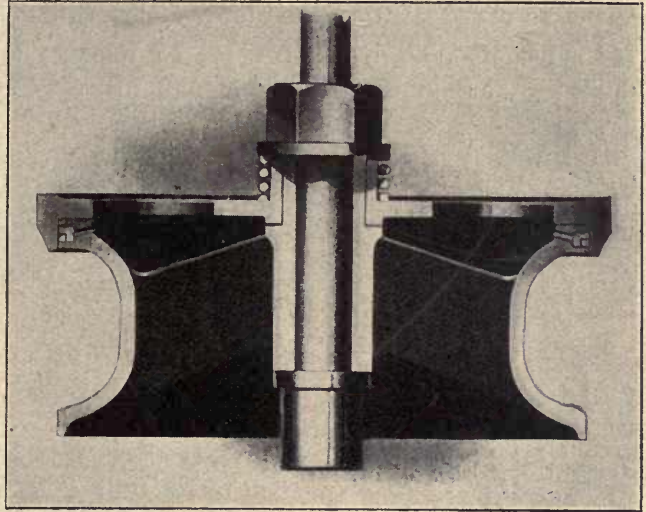


Fig. 51.

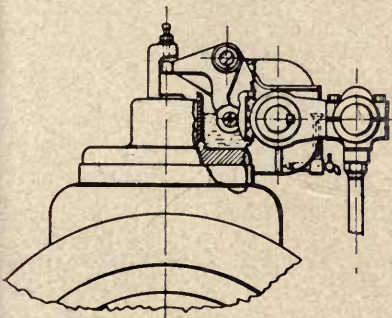


Fig. 52.

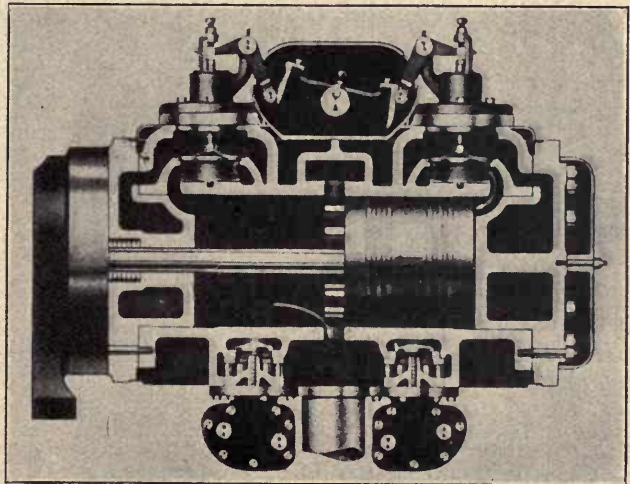


Fig. 53.

be a small increase in the surface loss. In order to keep the latter down to a minimum, the auxiliary exhaust valves should be placed on the cylinder barrel instead of in the heads, and arranged so that in the dead center position of the piston at least one, or preferably two rings seal the auxiliary exhaust ports.

If this is done, the compression steam, assisted later by the live steam, will close the valves before the piston uncovers their ports on the expansion stroke, whereby direct exhaust of live steam is avoided.

The auxiliary exhaust has no value for condensing engines; but some value for non-condensing una-flow engines with high back pressure and low initial pressure, where it will result in a reduction in steam consumption, especially in the case of jacketed cylinders, with the further advantage of higher mean effective pressures, and therefore smaller cylinders, driving parts and flywheels.

Figs. 49, 50, 51, 52, 53, 54, 55 refer to una-flow non-condensing engines built by the Skinner Engine Company, of Erie, Pa., U. S. A. The diagram (Fig. 49)

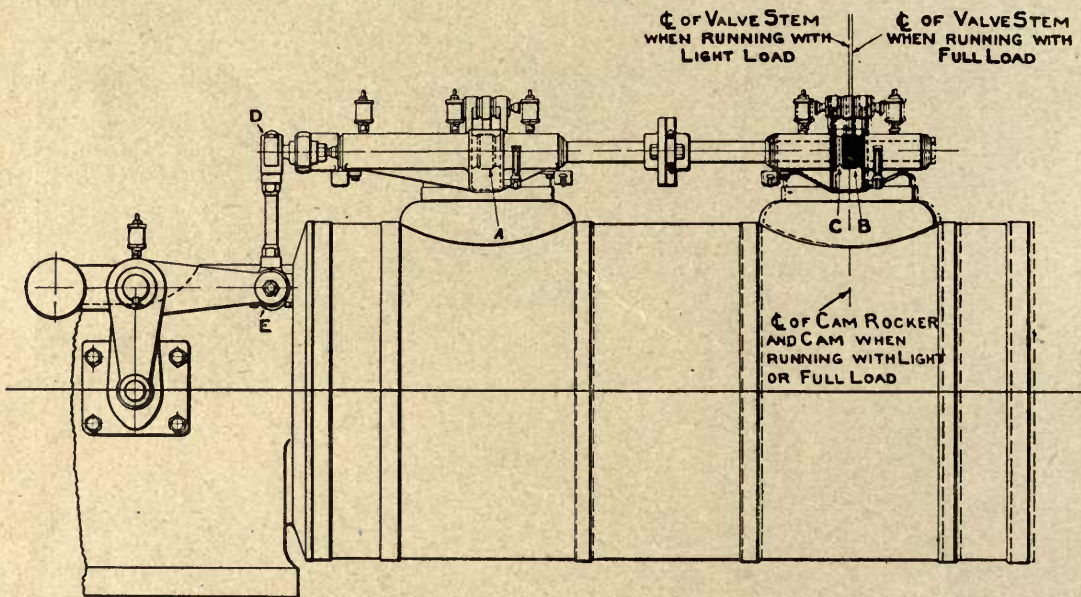


Fig. 54. Sectional View of Expansion-Compensating Gear.

shows delayed compression by the use of auxiliary exhaust valves (Fig. 50) arranged at an intermediate point of the stroke. The clearance space may be reduced as much as can be realized by the best practical design, and the ports leading to the valves may be arranged so as to give a compression complying with the rules developed on page 41, 42, 43. Single-beat valves are employed, since the pressure upon them is relieved before they open, by the piston uncovering the main exhaust ports. The auxiliary exhaust valves are arranged on the lower side of the cylinder for drainage. The inlet valves are placed on the upper side of the cylinder, and are constructed as double-beat valves (Fig. 51) in accordance with the principles utilized in the Sulzer valve shown in Fig. 10, p. 88. The upper valve face is formed on a disc separate from the main valve body, and the two parts are pressed together by a spring, thus allowing a limited amount of movement between them so that the faces can adapt themselves to a change in distance between the fixed seats due to expansion. Snap rings are fitted between the two parts of the valve so as to seal the joint. An eccentric controlled by a flywheel governor operates a rocking



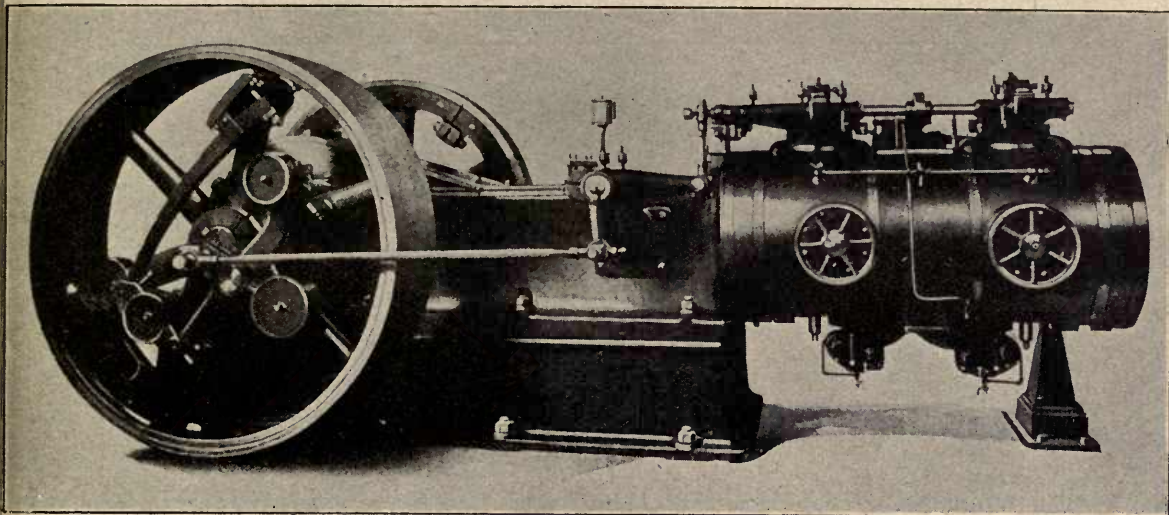


Fig. 55.

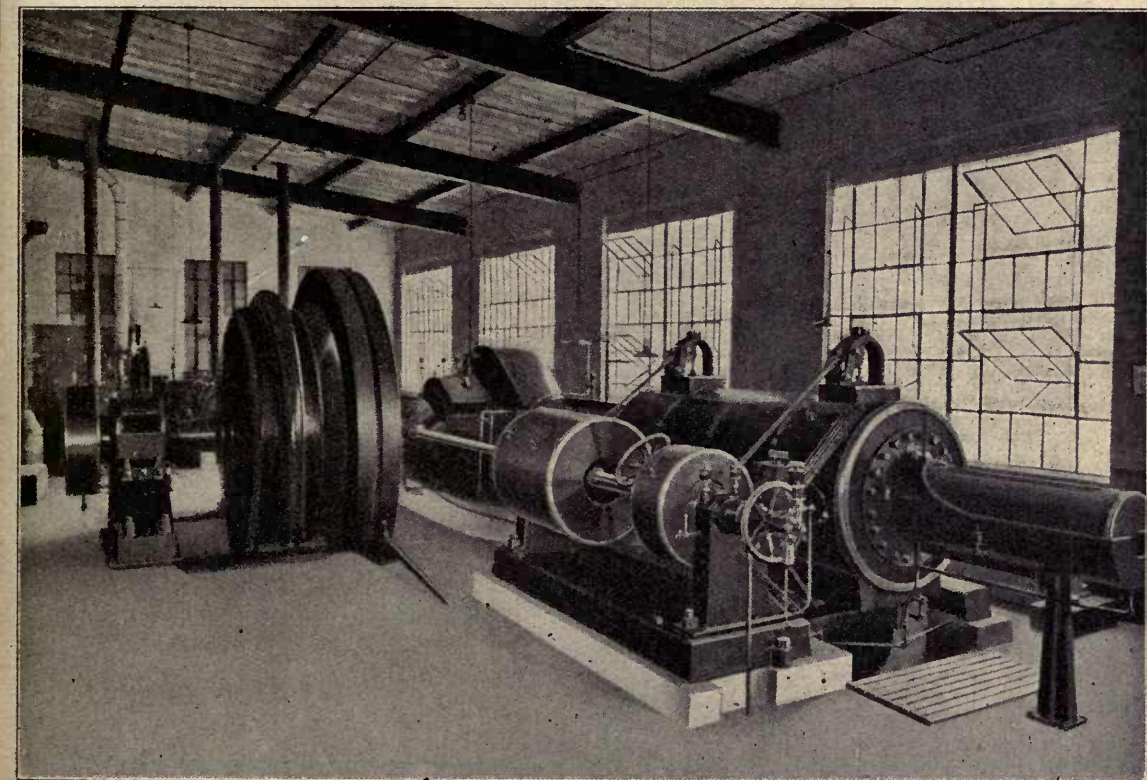


Fig. 56.

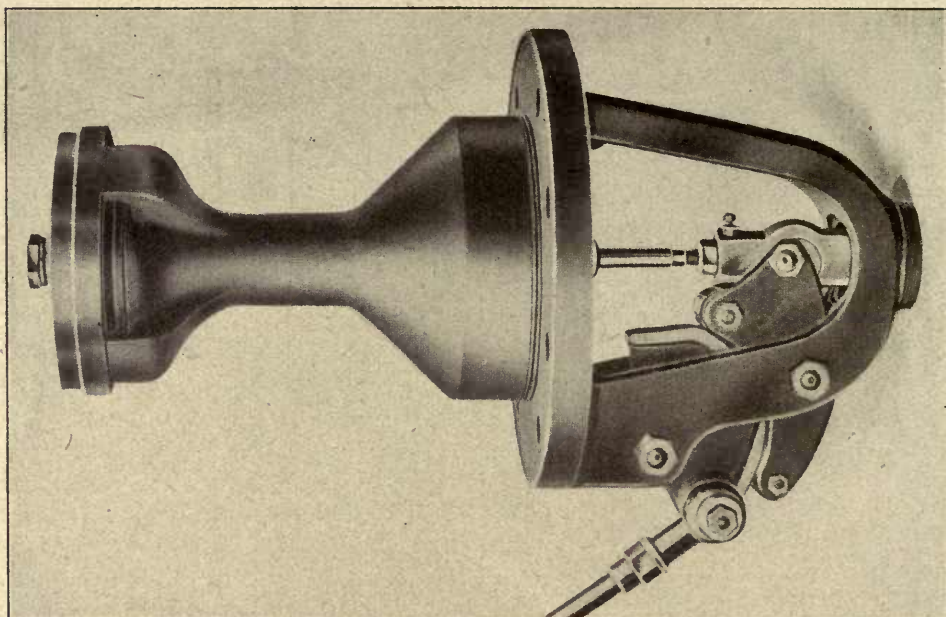


Fig. 58.

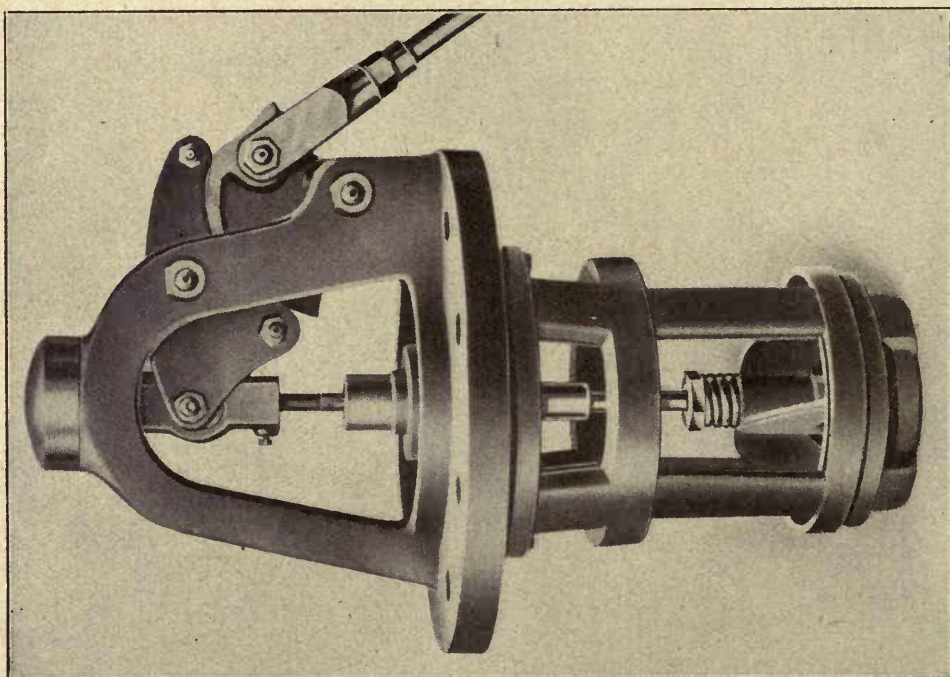


Fig. 57.

shaft placed between or alongside the inlet valves, the latter being actuated by cams and levers. The axial arrangement of the rocking shaft entirely eliminates the effect of the expansion of the cylinder on the steam distribution. The cam mechanism of both inlet and exhaust valves is enclosed in an oil bath.

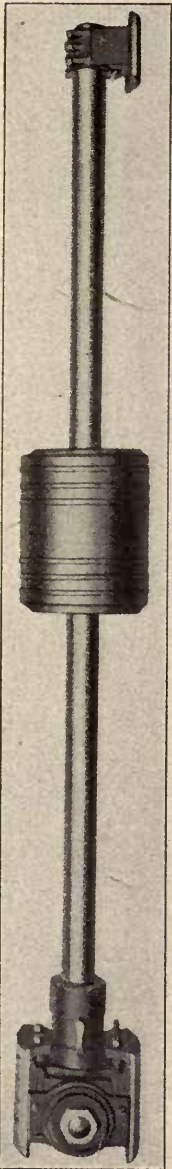


Fig. 59.

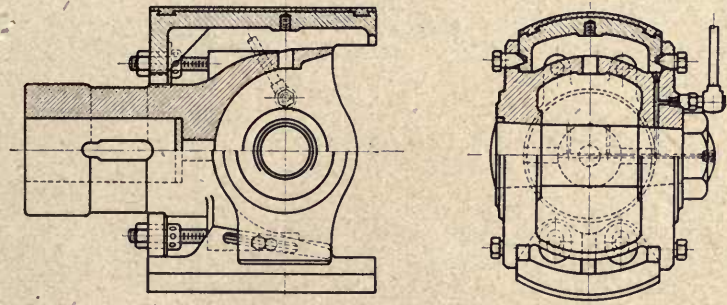
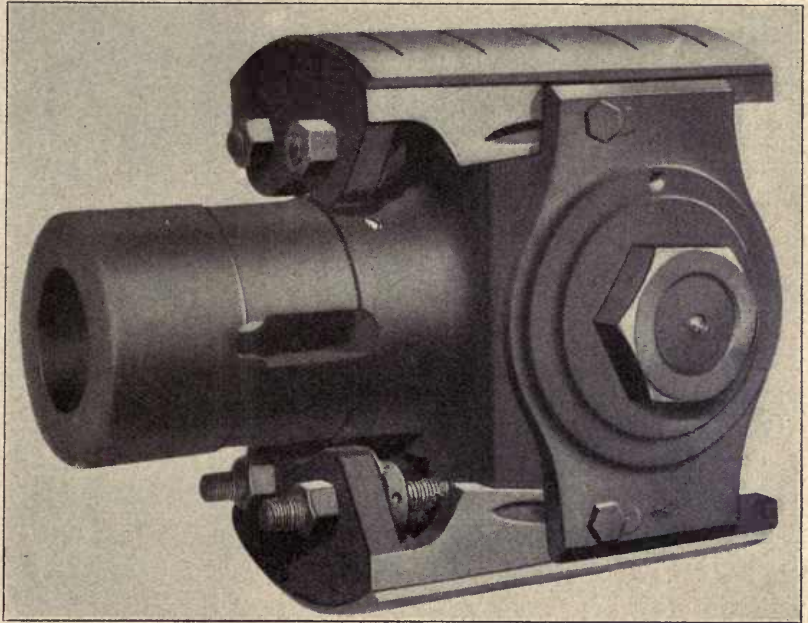


Fig. 60.

In Fig. 50 is shown a device to adapt the engine automatically to both condensing and non-condensing operation. The shaft *A* carries an idler lever *B* which is actuated by the rolling lever *C*. The latter is operated by the engine valve gear through the shaft *D* on the outside of the cam housing. The pocket *E* is connected to the central exhaust belt by means of a small pipe. A spring in this pocket bears on the idler shaft so as to keep the idler lever in register with the valve stem and the rolling lever *C* below it. When the vacuum increases sufficiently, the shaft

is drawn into the pocket against the spring, so that the idler and rolling levers no longer register and the valve remains closed. When the vacuum fails, the spring will cause the levers to fall in line, so that the valve becomes operative.

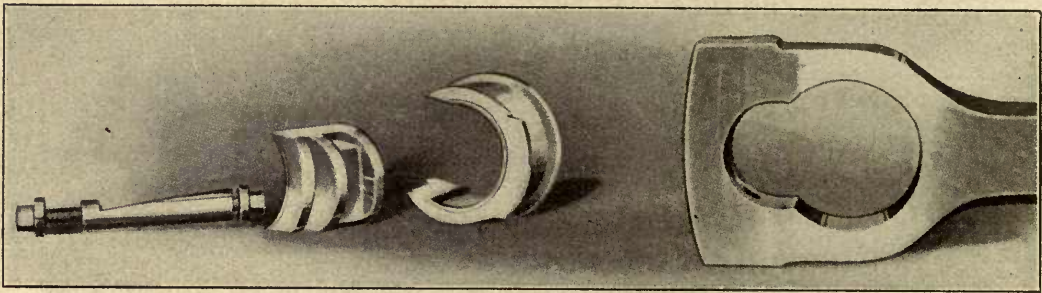


Fig. 61.

The Nordberg Mfg. Co., of Milwaukee, Wis., was the first American concern to take up the manufacture of una-flow engines with the constructional features proposed by the author, combined with a design according to their own practice (Fig. 56). The shaft governor on the lay shaft controls the valve mechanism in the usual way. The valves are positively opened and closed by cams, in accordance with the design originated by Prof. Doerfel, of Prague (Fig. 57 and Fig. 58). No springs or dashpots are required, except a short spring inserted in the connection between valve and valve stem, to insure proper closure of the valve.

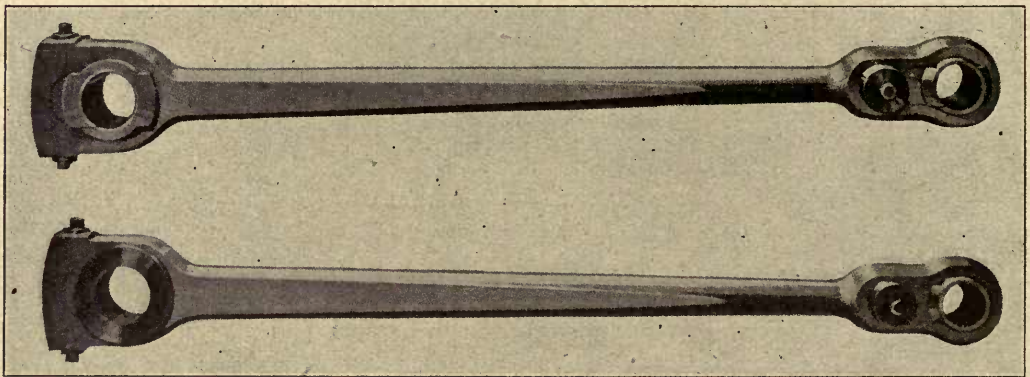


Fig. 62.

A synchronizing device is regularly furnished with all engines driving alternating current generators. A hand wheel is arranged at the end of the lay shaft, by means of which the tension of the governor springs may be varied while the engine is running to change the speed and to bring the generator into synchronism.

It should be noted that a tail rod and slipper are used (Fig. 59). In larger engines the piston rod is made hollow.

The crosshead (Fig. 60) carries a pin with tapered ends pulled into place by a large nut. The crosshead shoes are centered between the projecting flanges of the crosshead body, are faced with suitable babbitt metal and provided with a wedge and screw adjustment.

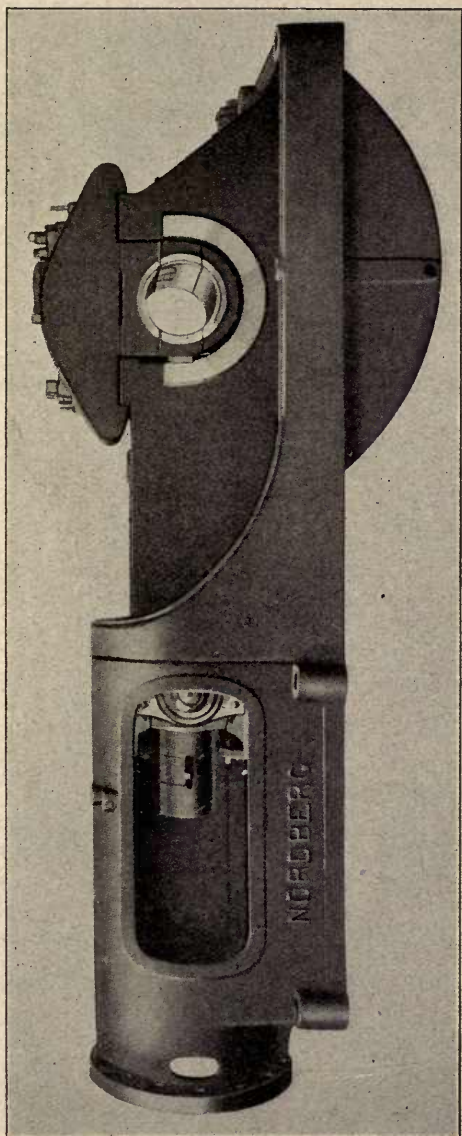


Fig. 63.

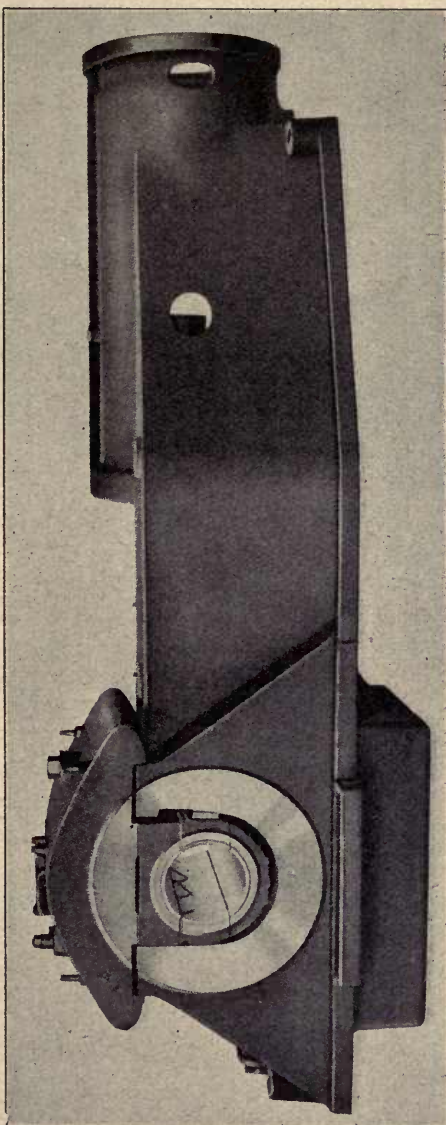


Fig. 64.

The crank end of the connecting rod is of especial interest (Fig. 61). The cylindrical stationary box is fitted into the bored eye of the rod. The adjustable box is slightly narrower than the diameter of the pin and fits into a recess in the rod. One side of the stationary box is cut away, forming a slot through which the adjustable box projects, its concave surface bearing against the pin. The stationary box is thus prevented from pinching the pin and from moving with the

latter. The adjusting wedge has the form of a cylindrical block of steel, one side of which is cut away to form a plane surface inclined to its axis and bearing against the corresponding inclined surface on the adjustable box. The wedge fits into

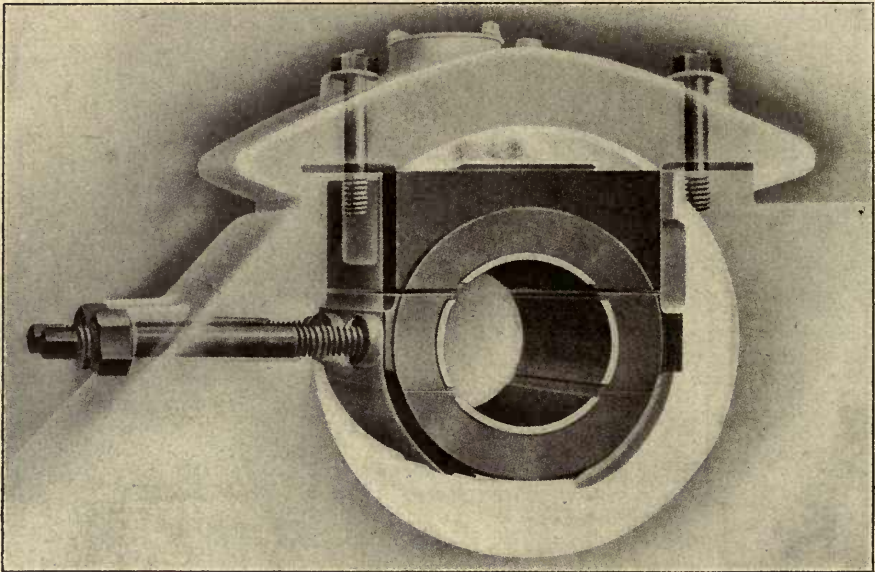


Fig. 65.

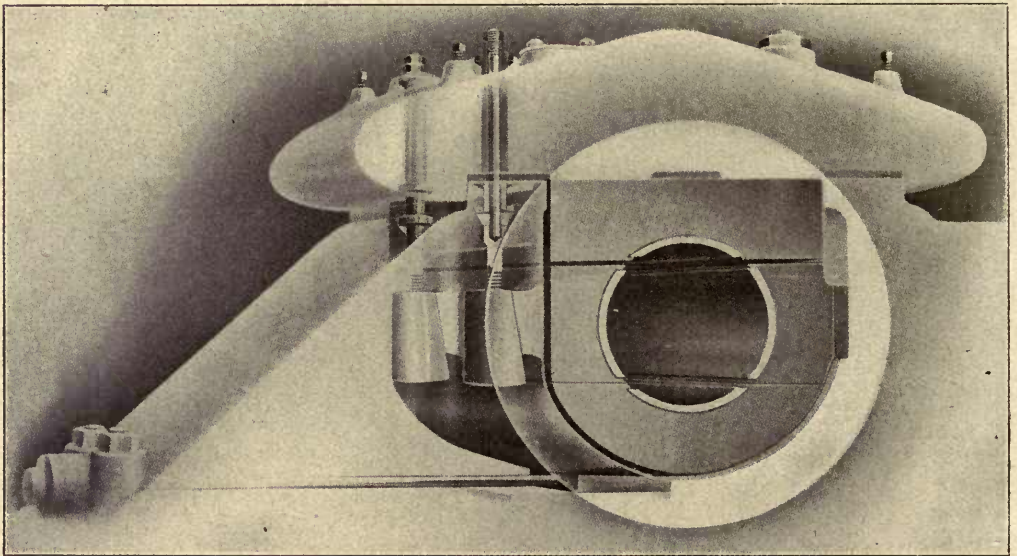


Fig. 66.

a reamed hole in the rod and is adjusted by cap screws locking each other. The small end of the rod is fitted with boxes of the same design (Fig. 62). This design combines simplicity of manufacture with thorough reliability in operation.

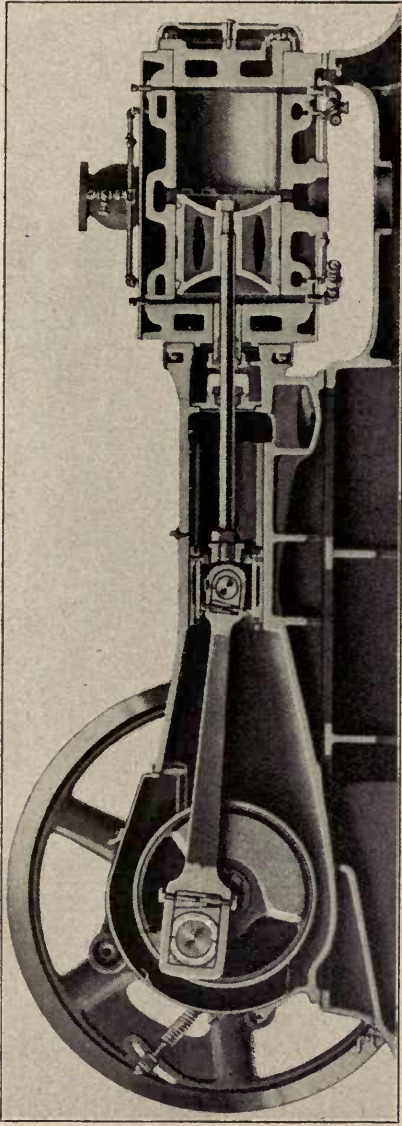


Fig. 67.

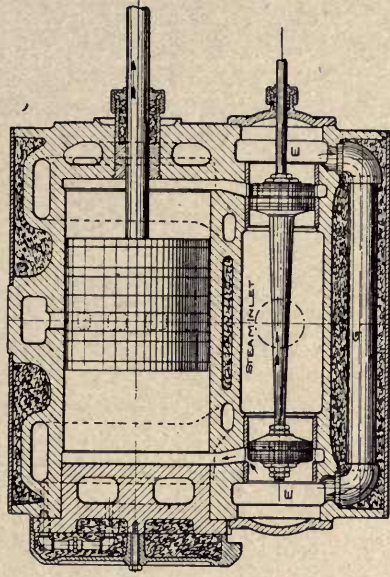


Fig. 68.

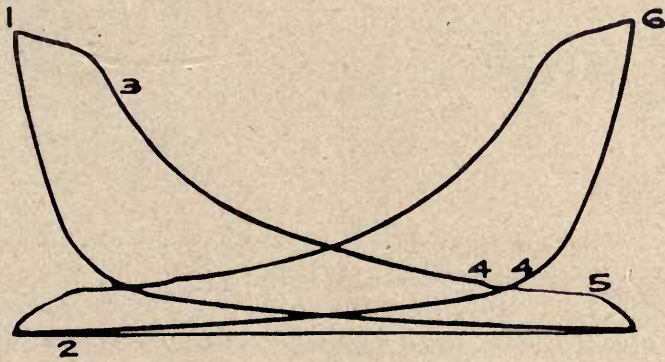
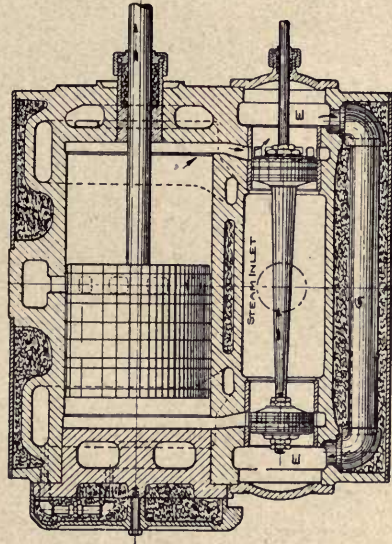


Fig. 69.

The frame (Figs. 63, 64) is cast in one piece with smooth surfaces and straight outlines. The center is kept as near to the foundation as possible and a great width is provided at the front of the guides, where the bending moment is a maximum. The frames are cast base uppermost, thus insuring good clean metal in the guides

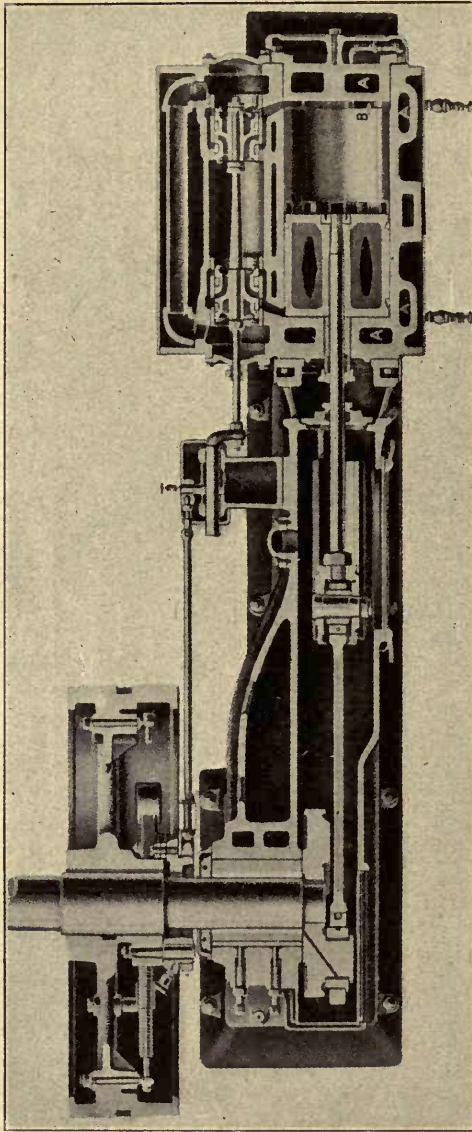


Fig. 70.

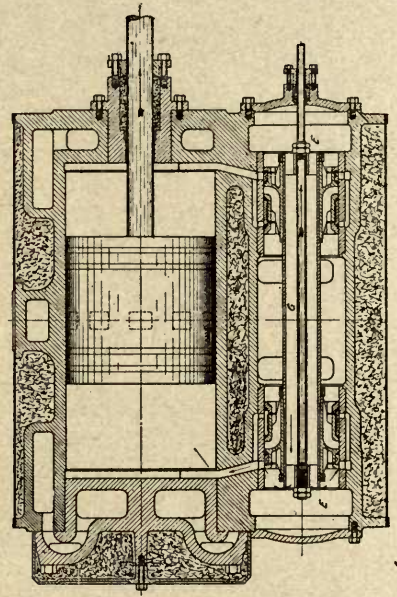
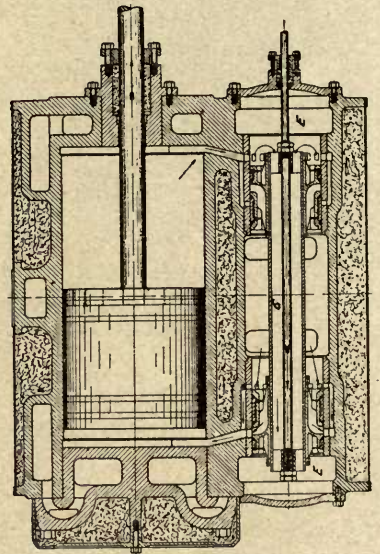


Fig. 71.



and the line of stress. Provision is also made in the design for the collection of the oil and its return to the lubricating system.

The moving parts of the engine are oiled by a gravity overhead lubricating system. The cylinder is lubricated by a mechanical force feed lubricator distributing oil positively to the proper points.



The main bearings (Figs. 65 and 66) are of the quarter-box type, lined with babbitt metal. The cap forms a strong tie and is relieved in the middle so that it exerts pressure directly over the quarter boxes. In the construction shown in Fig. 65, the adjustment is effected by means of heavy set screws, which are provided with steel contact blocks to prevent them from wearing into the quarter boxes, while in Fig. 66 the same effect is obtained by vertical wedges operated by screws passing through the cap.

The Nordberg Mfg. Co. also builds una-flow engines with auxiliary exhaust valves which may be put in or out of operation thus making the engines suitable for both condensing and non-condensing service.

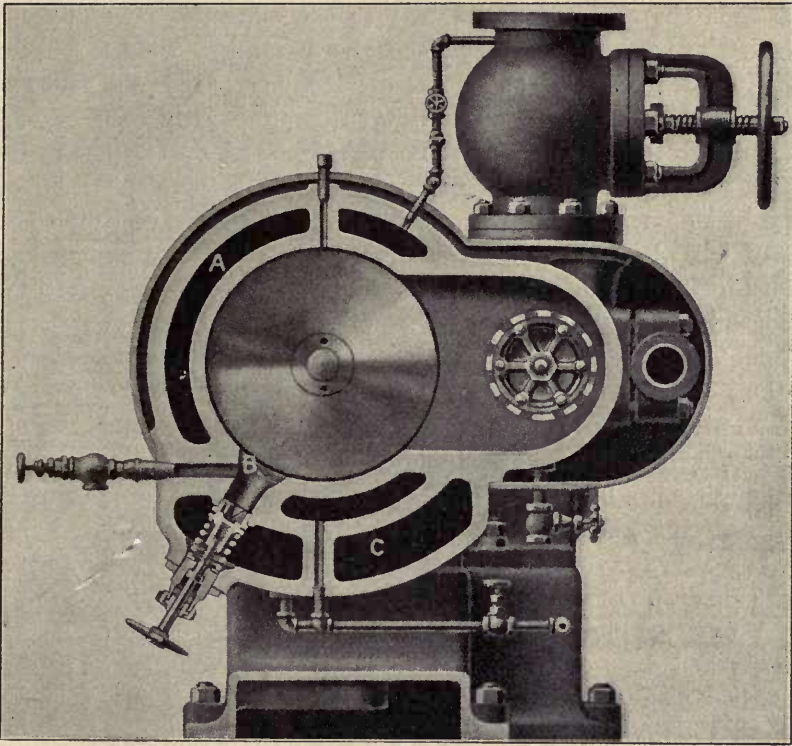


Fig. 72.

Owing to careful use of those principles which have proved successful in Europe, especially those developed by the author, the una-flow engines built by the Nordberg Mfg. Co. may be considered among the best American machines of this type. Their first engine was fitted with Corliss valves as described in chapter 2—2, page 184. Still further improvement in these engines might be made by the application of high lift single beat valves without cages, thereby reducing the clearance, the harmful surfaces, and leakage, so that the water rate might be still further improved.

The dual clearance una-flow engine built by the Harrisburg Foundry & Machine Works, of Harrisburg, Pa. (Fig. 67) is of especial interest. As the name

implies, this engine has two clearances, the first, or cylinder clearance, between the piston and the valve, and the second (*EGE*, Fig. 68) connecting the outer ends of the valve. In the earlier design this connection was by an external pipe (Fig. 68) but a hollow valve is now used (Fig. 71). The latter is an ordinary piston valve with snap-rings, moving in a ribbed bushing and having inside admission, as in locomotive practice with superheated steam. As indicated in the figure, the cylinder clearance is kept as small as possible. The residual steam is first compressed into both clearance spaces together, which are at that time in connection through the piston valve. Towards the end of the stroke the auxiliary clearance is shut off, so that the steam is compressed into the cylinder clearance alone. The valve then automatically connects the auxiliary clearance with the opposite end of the cylinder so that the steam compressed into the clearance now mixes with, and expands with the working steam on the return stroke. This arrangement is of course only justified for non-condensing service, so as to avoid a large clearance or auxiliary exhaust valves. The una-flow principle is fully adhered to, since the exhaust steam only leaves through the central exhaust ports. The series arrangement of live steam, inlet valve, piston and exhaust is also retained, so that any leakage of steam past the piston valve cannot pass directly to the exhaust. The effect of this dual clearance principle is to raise the expansion line and lower the compression line (Fig. 69). Consequently the mean effective pressure, output and uniformity of speed are somewhat increased and the necessary flywheel weight is decreased.

Conditions in an engine of this type for condensing service are somewhat different. The piston heads are flat, but in spite of this there remains a clearance of from 5% to 7%. In this case also the auxiliary clearance connects the valve head pockets. In addition, a further clearance pocket is arranged to be connected to the cylinder by a spring-loaded valve, which may be opened or closed by hand, or operated automatically, thereby adapting the condensing cylinder to non-condensing service (Fig. 72). Increased compression will cause the valve to open against the spring, thus relieving the pressure by admitting steam into the pocket.

The heads and ends of the cylinder barrels are jacketed for both condensing and non-condensing service. The piston valve is actuated in both cases by an eccentric on the crankshaft controlled by a shaft governor.

The Filer & Stowell Co., of Milwaukee, Wis., successfully built a una-flow engine with drop piston valves and a valve gear resembling a Corliss gear, the valves being located at the side of the cylinder barrel. In the later type, the valves were placed in the heads on the cylinder center line, thus decreasing the clearance and making a better jacket arrangement possible. For higher engine speeds, poppet valves were adopted later, operated from eccentrics on a lay shaft, with a positive opening and closing motion, the eccentrics being controlled by a lay shaft governor placed between them. The result is an engine similar in many respects to the Nordberg construction, the chief points of difference being the valve gear and bonnet design. The Filer & Stowell Co. evidently consider thorough jacketing of much importance, and therefore their claim of a consumption of  $13\frac{7}{8}$  lbs. of saturated steam per IHP per hour for a una-flow engine having a  $16 \times 30''$  cylinder, 125 lbs./sq. in initial pressure, 25'' vacuum and 150 r. p. m. may well be credited. For

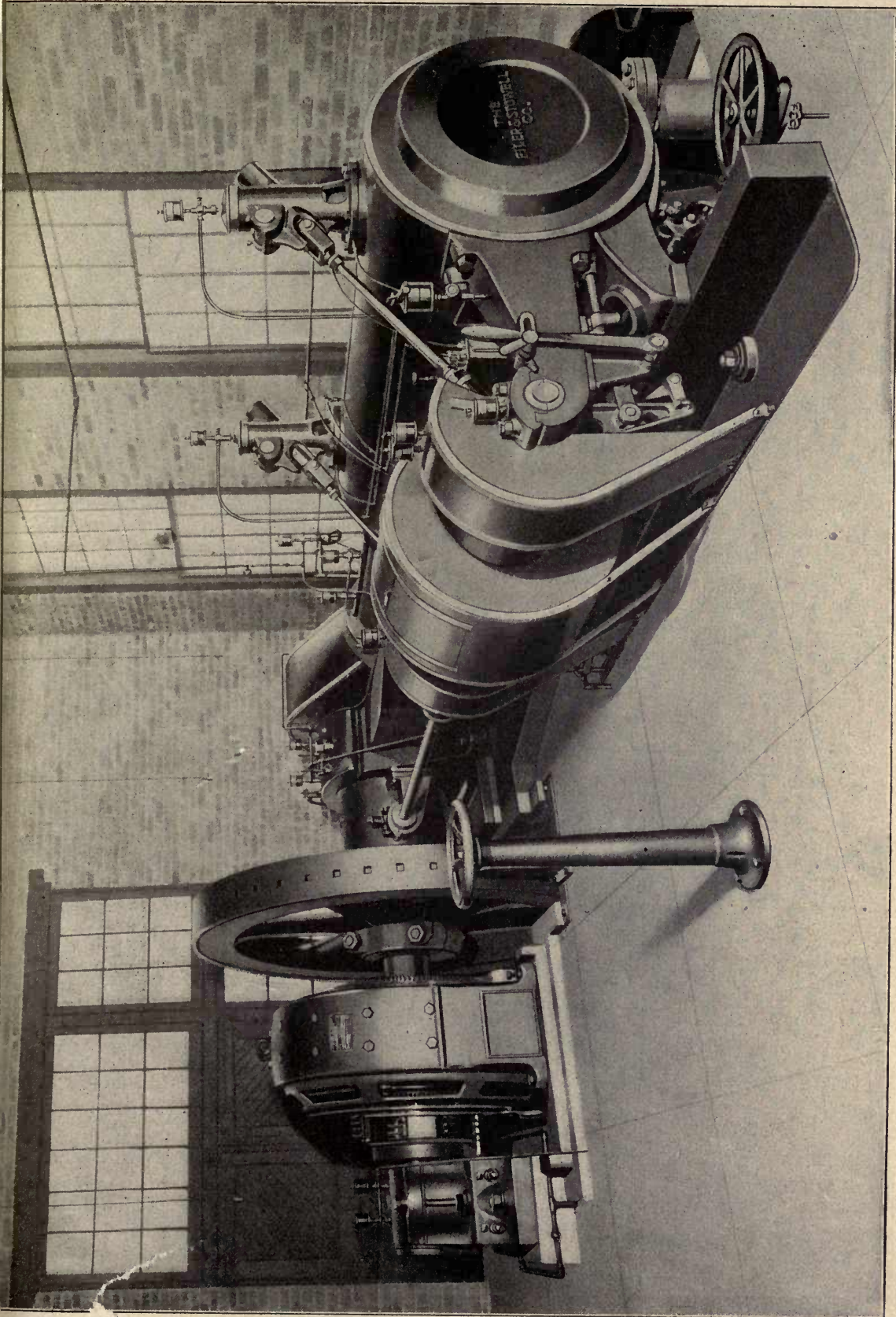
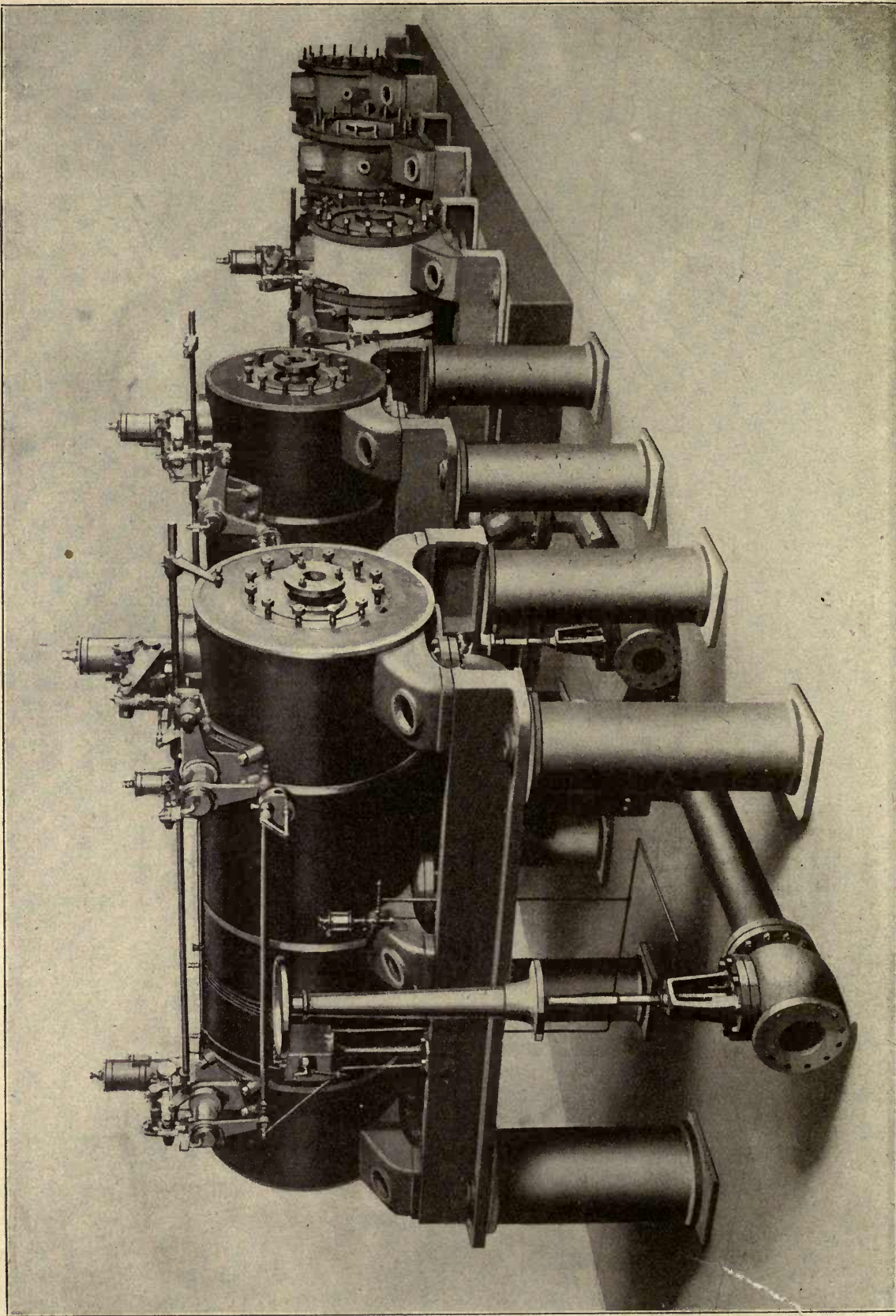


Fig. 73.



these engines also the next logical step would be to adopt the single-beat valves actuated from a double-speed lay shaft.

Fig. 73 illustrates a Filer & Stowell  $20 \times 22''$  una-flow engine driving a 200 kW direct current generator. This engine is arranged for condensing and non-condensing service, auxiliary valves being employed in preference to clearance spaces because of more or less extended periods of operation with as high a back pressure as 5 lbs/sq in. The clearance space formed in each head by the auxiliary exhaust valve pocket may be closed off by a hand-operated clearance valve, so that no clearance is added when running condensing. If, for some reason, the vacuum should drop to 20'' or 22'', the hand-operated clearance may be opened, thus adding the clearance formed by the exhaust valve pocket, the valve itself remaining closed. If the back pressure is further increased, the mechanism actuating the exhaust valves may be put in action and the length of compression varied to suit the back pressure while the engine is in operation.

Fig. 74 shows a group of five  $18 \times 42''$  una-flow cylinders which are part of an order of six  $18 \times 42''$  and six  $20 \times 48''$  cylinders. Four of the  $18 \times 42''$  cylinders are to take the place of those of two 18'' and  $36 \times 42''$  cross-compound corliss engines driving generators, and the two others are to replace those of two ammonia boosters. The six  $20 \times 48''$  cylinders are to supplant cross-compound cylinders driving ice machines. All these engines are installed at Swift & Company's plant at La Plata, Argentine Republic, and are to operate with 175 lbs/sq in. steam pressure and  $150^\circ$  superheat. All these cylinders have additional clearance spaces and clearance valves for non-condensing service. The trend of development is thus the same as in Europe, where many old compound cylinders are being replaced by single-stage una-flow cylinders.

## 2. The Corliss Una-Flow Engine.

Figs. 3 and 1 show a side elevation, a vertical section and an indicator card of a condensing Corliss una-flow engine. The eccentric on the crank shaft directly operates the two valves placed in the cylinder heads. The release is effected in the ordinary way by a cam under control of the governor. The valves are closed by oil-vacuum dash pots (Fig. 2) which have absolutely no rebound after the valve has closed. The oscillation which is so common with air dash pots is entirely avoided, since air which is a compressible medium is replaced by oil which is incompressible. For this reason the lap of the valve can be made extremely small

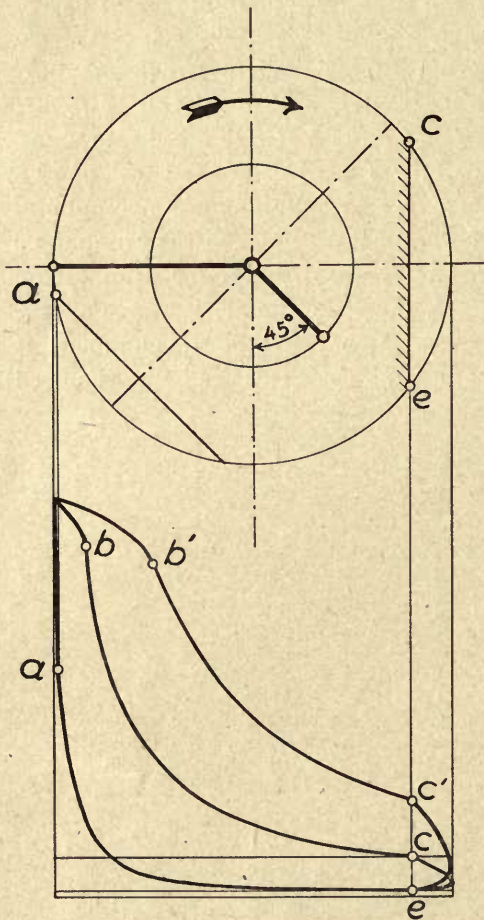


Fig. 1.

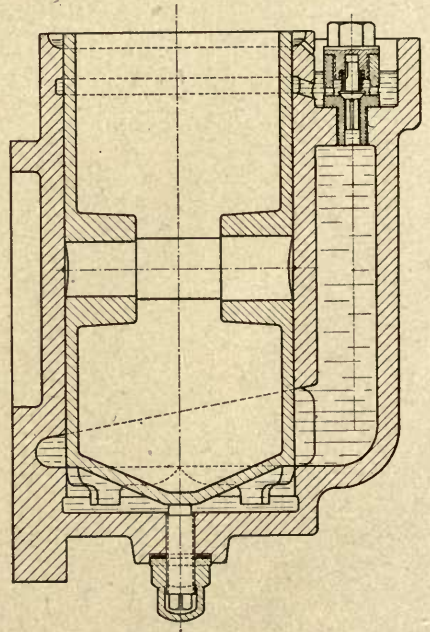


Fig. 2.

and the latch only takes hold and begins to move the valve at a time when the latter is already partly balanced by the compression (Fig. 1). Further experience is required to find the smallest allowable lap of the valve in combination with the proper construction of a reliable oil vacuum dash pot which exactly locates the

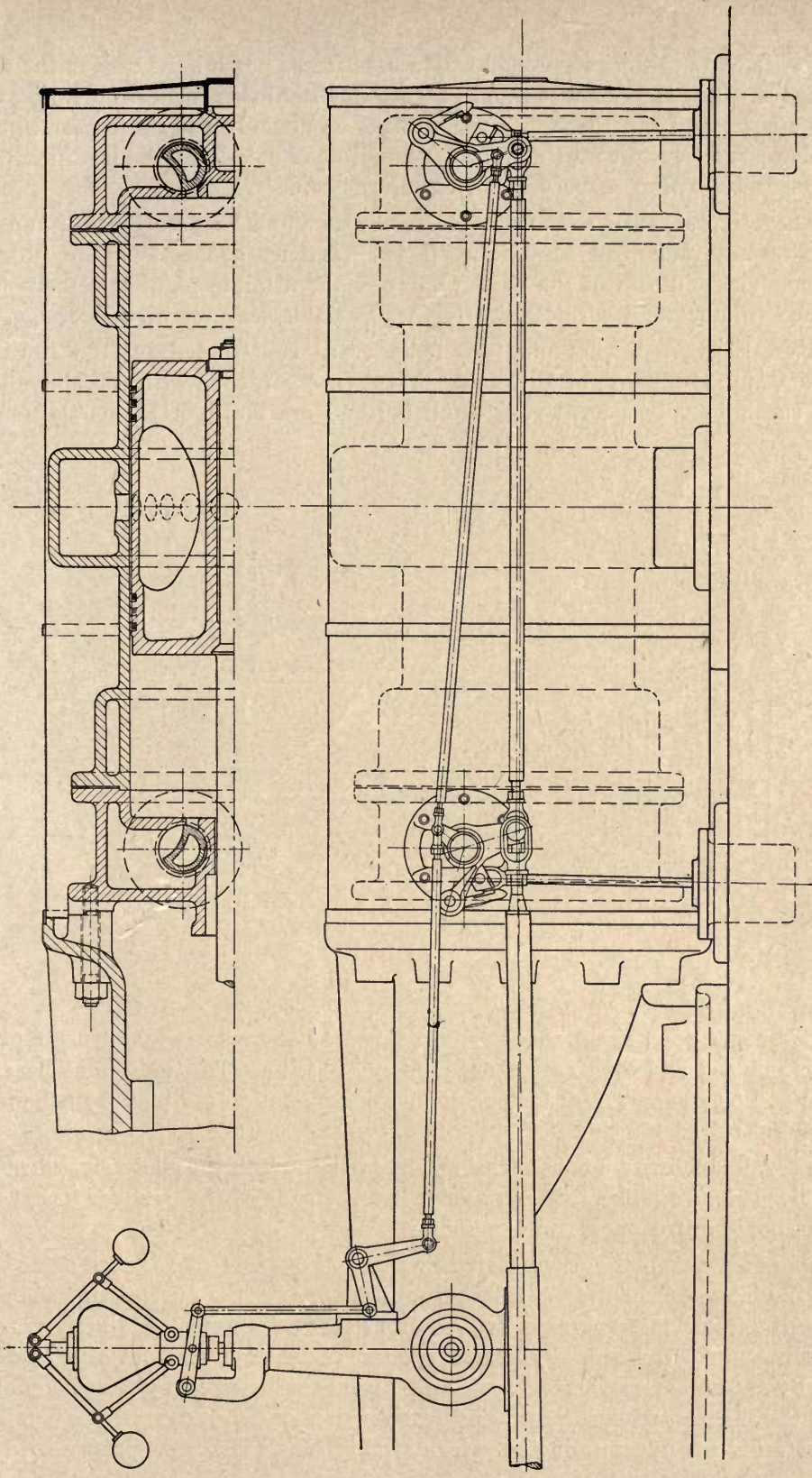


Fig. 3.

valve in its end position, in order to reduce as far as possible its movement when unbalanced. In this manner it should be possible to obtain reliable operation with high pressures and superheat. Provision must be made in the valve gear to close the valve positively in case the force of the oil dash pot should be insufficient for proper closure, owing to very small cut-offs or other reasons.

A negative angle of advance of  $45^{\circ}$  gives an ample range of cut-off and also insures release under all conditions, if the governor connections are properly adjusted. The omission of the wrist plate and the attainment of extremely small clearance volumes and surfaces are further valuable features of this design.

Fig. 4 shows a Corliss una-flow cylinder as constructed by the Nordberg Manufacturing Company, of Milwaukee, Wis. In accordance with the above principles, the inlet valves have very small lap and are multiported in addition, so

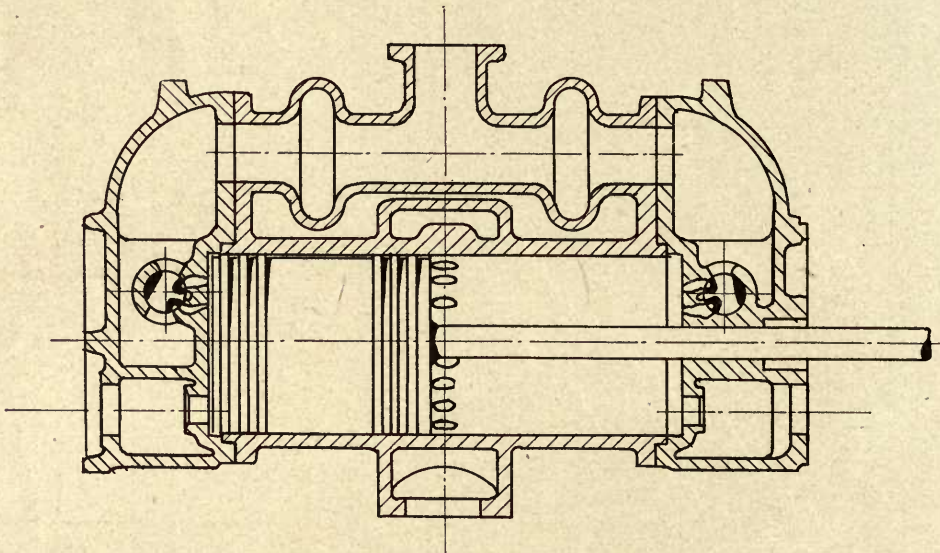


Fig. 4.

that four edges open simultaneously. In this way the rotative movement of the valve is reduced and high speeds are rendered possible. The additional clearance volume and clearance valves for non-condensing operation are placed in the lower part of the cylinder heads.

In Fig. 5 is shown a non-condensing Corliss engine with the inlet valves arranged in the heads, the auxiliary exhaust valves at the ends of the cylinder barrel, and the una-flow exhaust ports in the center.

The eccentric on the crankshaft has a negative angle of advance of  $15^{\circ}$  and drives the inlet valves directly through an ordinary Corliss mechanism, while the motion of the exhaust valves is derived from that of the inlet valve levers. The inlet valves have the ordinary releasing gear. Admission and cut-off are determined by the steam valves, the beginning of exhaust is fixed by the piston uncovering the central exhaust ports and compression is delayed until the auxiliary exhaust ports are overrun on the return stroke. The valve gear proper therefore



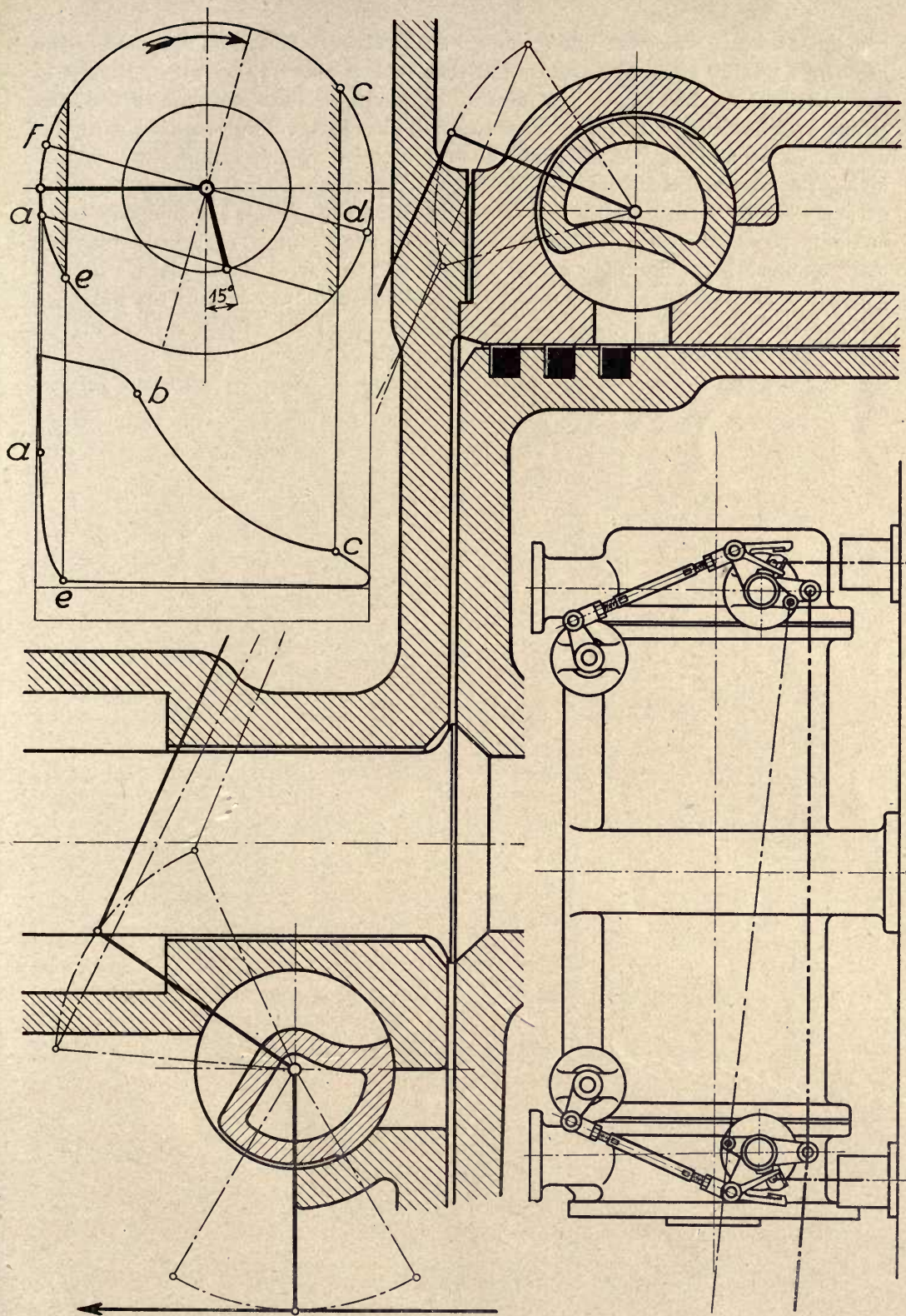


Fig. 5.

has no influence whatever upon the exhaust phases. This renders possible the use of a negative angle of advance and therewith a range of cut-off of from 0 to more than 60%. The length of compression may be reduced to about 8% of the stroke in connection with the extremely small clearance volume realized with this design. The auxiliary exhaust valves are protected by the piston rings against high pressures and temperatures during a considerable part of the admission period. They are subject to pressure only after the piston has uncovered the auxiliary ports, and do not open until the outer dead center is reached, when the main exhaust ports are wide open. Closure of the valves takes place after the piston has again covered the auxiliary ports. The actual closure of the auxiliary exhaust is therefore so rapid that the indicator card shows sharp corners at this point. Since the inlet valves also close quickly, and as the clearance volume and surfaces are small, a low steam consumption may be expected with this type of engine.

### 3. The Una-Flow Engine arranged for Bleeding.

Steam may be withdrawn or bled from a una-flow cylinder by means of check valves placed at suitable points, as shown in Fig. 1. For instance, by providing ports at a distance of say 10% of the piston stroke from the opening edge of the main exhaust ports, the steam withdrawn through the former may be used in heating systems, to drive exhaust steam turbines or engines, or for other purposes. It is possible, for example, to withdraw steam at a pressure of 0,5 to 1,0 at. abs. from the cylinder of a condensing engine and to use it in an exhaust steam turbine driving a rotary air pump. The bleeder valves could also be placed closer to the

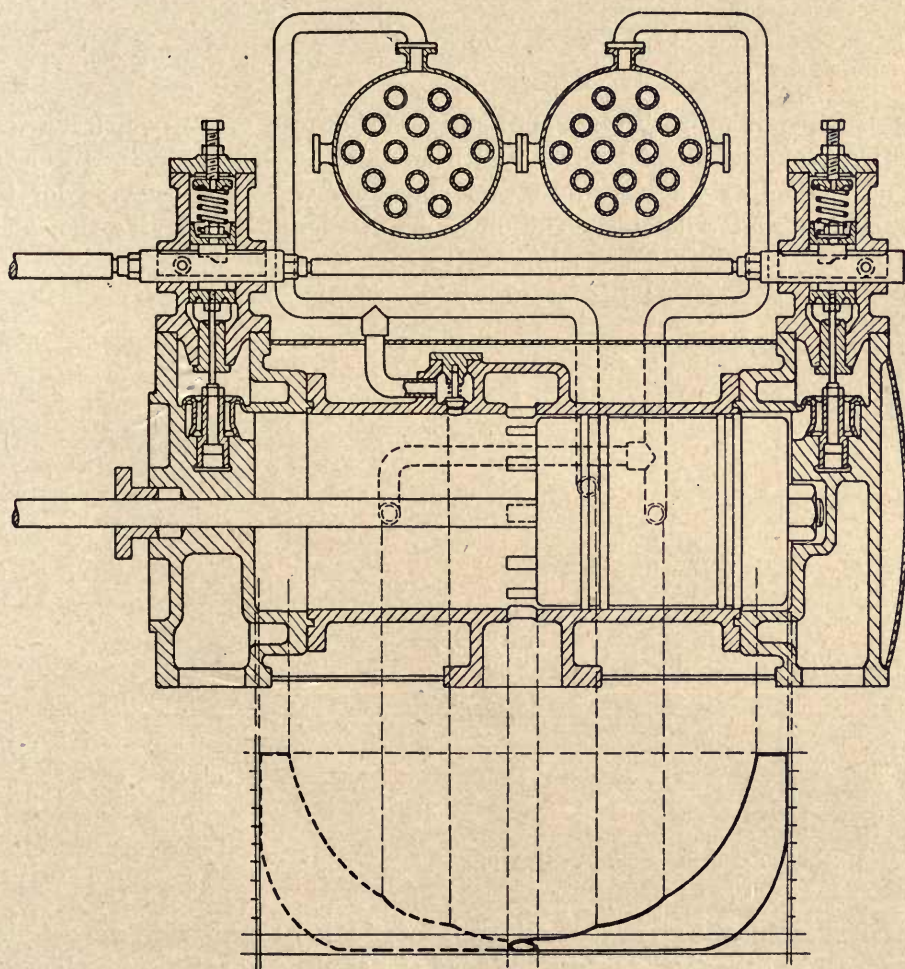


Fig. 1.

cylinder ends in order to withdraw steam at a higher pressure for heating purposes and the like. A plurality of such heating systems may thus be arranged in series, as shown in Fig. 1, for heating the feed water to a high temperature. In this case, however, a more or less noticeable loss of diagram area must be expected.

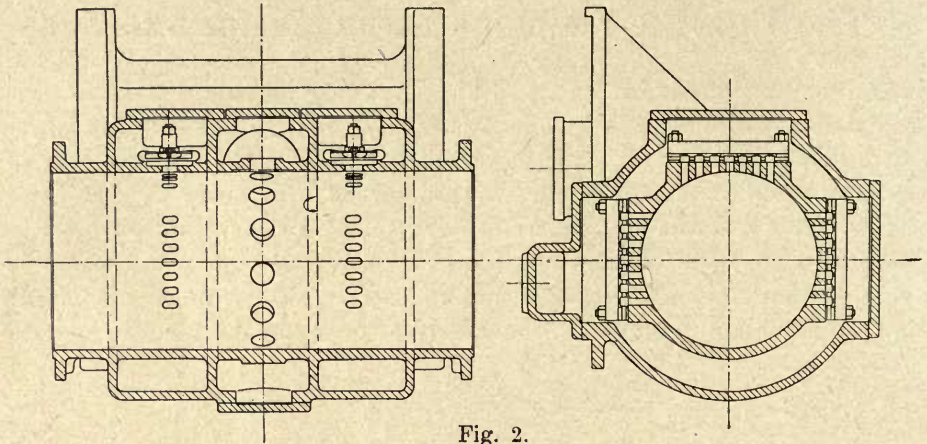


Fig. 2.

An example of such withdrawal of steam is shown in Fig. 2, which illustrates a uniflow locomotive cylinder fitted with automatic bleeder valves. In locomotives this method of withdrawing steam may very well be considered for train heating or feed water heating. The diagrams of Figs. 3 and 4 give the quanti-

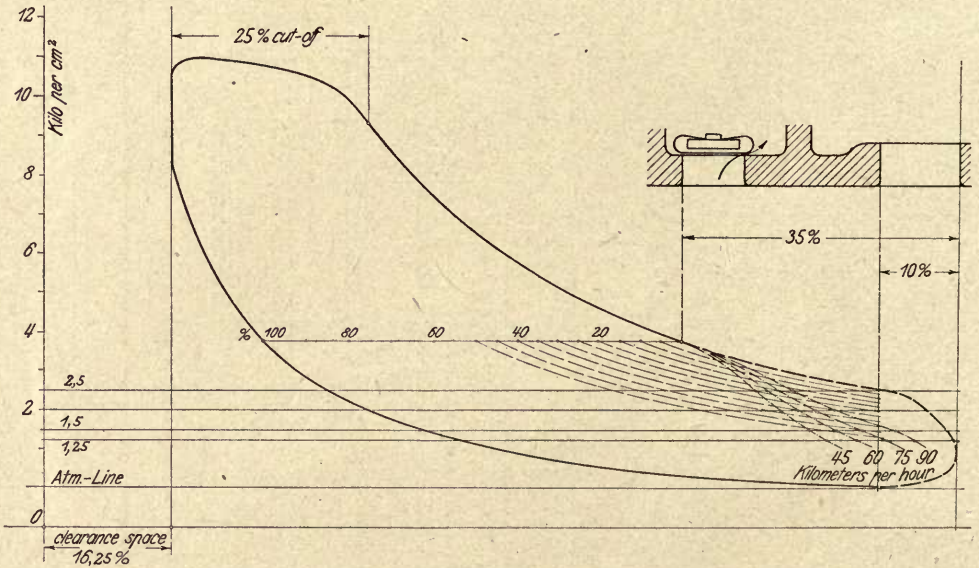


Fig. 3.

ties which may be withdrawn at different locomotive speeds with valves placed at 35 and 50% of the stroke before the dead center. The quantities of steam withdrawn are the larger, the greater the area of the valves, the greater their distance

from the exhaust end, the lower the speed and the lower the required pressure. The following table gives the quantities of steam withdrawn for different engine speeds and pressures of the heating steam, the bleeder valves being situated either 35 or 50% of the stroke from the outer dead center. The figures denote quantities of steam withdrawn in percent of the total working steam in the cylinder.

### Steam quantities withdrawn:

Pressure in receiver kgs. per cm <sup>2</sup>	Cut-off at quarter of the stroke			
	45 km per hour	60 km per hour	75 km per hour	90 km per hour
Withdrawal valve 35% before the end of the stroke:				
1.25	59.0%	55.0%	52.0%	43.0%
1.5	51.0	48.5	46.0	41.0
2.0	37.5	35.2	32.5	30.0
2.5	25.0	22.5	20.0	17.0
Withdrawal valve midway in the stroke:				
2.5	41.8	39.4	37.0	33.6
3.0	29.4	27.0	25.1	22.8
3.5	20.1	18.7	17.0	15.3
4.0	11.3	10.3	9.2	7.9

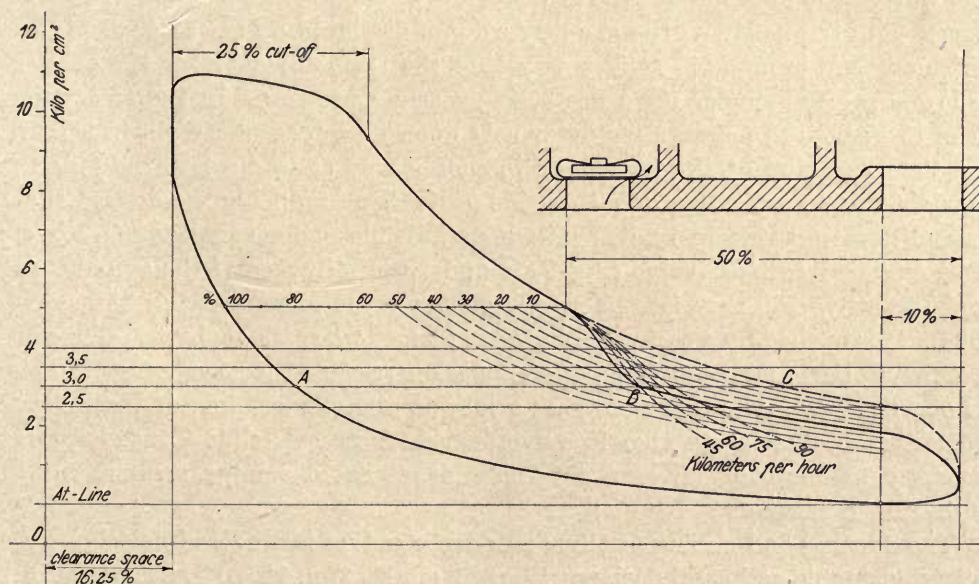


Fig. 4.

The amount of steam which can be withdrawn from the cylinder of a una-flow condensing engine will of course be considerably smaller than in a non-condensing locomotive.

This very important problem of bleeding steam may also be solved by means of a compound una-flow engine with a tandem arrangement as shown in Fig. 5. The piston of the high pressure una-flow cylinder is fitted with a piston valve driven from the main connecting rod, which provides the necessary short compression. The same effect may be obtained by the use of automatic auxiliary exhaust valves operated by the cylinder steam and placed near the ends of the cylinder, their ports being controlled by the piston (Fig. 6). The low pressure cylinder is of standard una-flow construction, although its clearance volume must be increased to about 7 to 10% according to the receiver pressure. The cut-off of the low pressure cylinder may be controlled by a pressure regulator under the influence of the receiver pressure (Fig. 7). This regulator consists of a cast iron housing partly filled

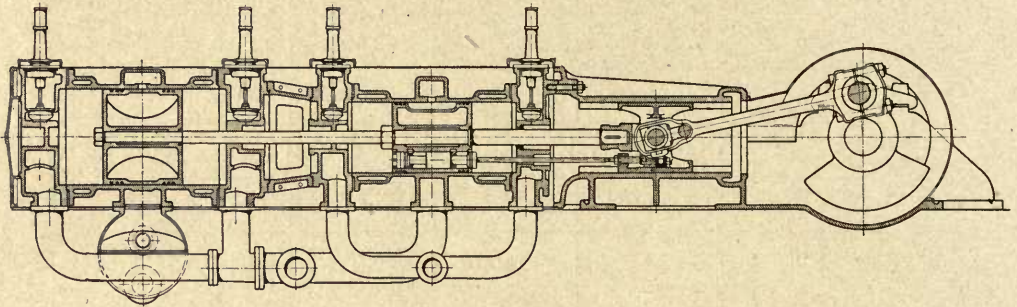


Fig. 5.

with mercury carrying an iron float, the upper end of which is connected in a suitable way to the inlet gear of the low pressure cylinder. The position of this float changes with the height of the mercury column displaced by the receiver pressure. The connection is made in such a way that the regulator shortens the cut-off of the low pressure cylinder for a decreasing receiver pressure. In the arrangement shown in Fig. 7 the pressure regulator acts upon an intermediate pin in the drive from the eccentric to the inlet valves, in such a way as to displace the rods from a straight line to a position on either side of it, thus producing the desired change of cut-off, within certain limits, with a permissible change in lead. The piston of the auxiliary exhaust valve (Fig. 6) is under the influence of the cylinder pressure. The valve will therefore be closed whenever the pressure inside the cylinder is high. It is opened by a spring in the valve bonnet when the main piston uncovers the exhaust ports and also when the expansion reaches the back pressure before this occurs. The losses accompanying a loop in the exhaust line of the indicator card for small cut-offs are therefore avoided. It is also possible to use large high pressure cylinders even for long cut-offs and yet avoid a large pressure drop at the end of expansion.

The opening and closing of these automatic valves is rendered noiseless by an adjustable double-acting oil dash pot (Fig. 48, ch. II, 1, p. 166). The lower resilient seat insures tightness of the valve. The design permits of ample valve lift and

valve areas, quiet operation and small clearance, as well as very favorable sealing conditions during the first and last part of the stroke, when the piston rings come between the inlet and auxiliary exhaust valves. Further valuable features of this design are found in the arrangement of all the valves and their gear on top of the cylinder, and the unhampered disposal of all the piping together with the condenser underneath the same, so that every pipe flange is easily accessible.

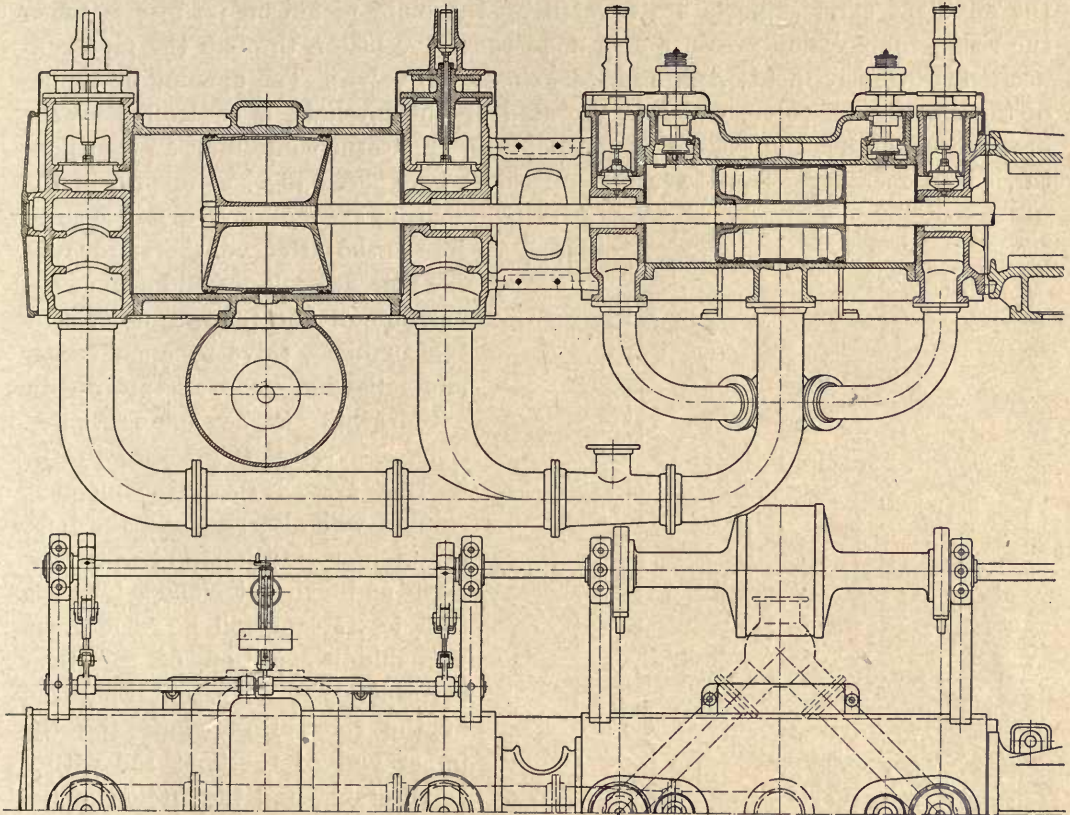


Fig. 6.

The exhaust valves of the high pressure cylinder may also be arranged in the more usual way with separate valve gear, possibly with omission of the central exhaust.

In Fig. 8 is shown an arrangement which makes it possible to withdraw steam during both the expansion and compression strokes. The una-flow cylinder of standard design is fitted at each end with an automatic auxiliary exhaust valve controlled by the cylinder steam as previously described. The upper end of the stem of the balanced valve carries a piston working in a cylinder the upper side of which is connected by a pipe with the corresponding end of the engine cylinder. This pipe connection is fitted with a reducing valve which opens towards the valve cylinder when a certain pressure is reached. The same end of the valve cylinder also has a second pipe connection leading to a pilot valve communicating with the

condenser, which is operated by a mechanism driven by the layshaft. When this pilot valve is lifted, pressure release occurs above the piston of the auxiliary exhaust valve, and the latter is opened by its spring, thus admitting steam from the engine cylinder into the heating connection. When the pressure inside the cylinder falls to or below that carried in the heating system, a return flow of steam is prevented by the closure of a number of automatic metal strip flap valves disposed around the auxiliary exhaust valve. The latter, however, remains open until after the auxiliary exhaust ports are covered by the main piston on its return, when the rising compression pressure acts upon the valve piston through the pipe connection previously mentioned, and thus closes the valves. The opening or timing of the small pilot valve, which is operated by the layshaft, is controlled by the pressure in the heating system by means of an apparatus containing an iron float carried on mercury. The lower mercury level is exposed to the pressure in the

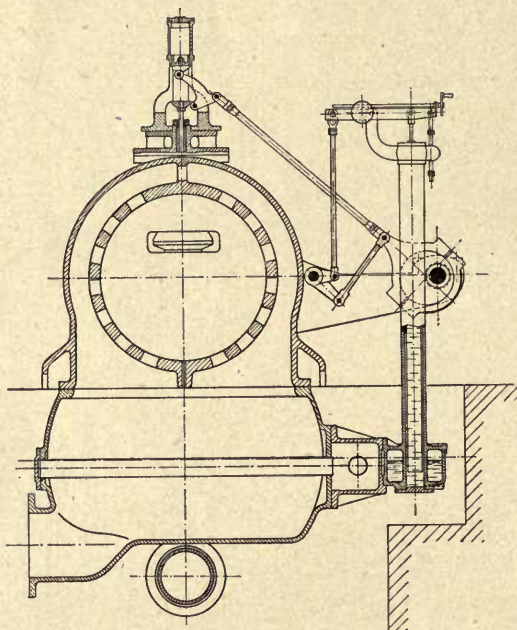


Fig. 7.

heating system, and a fall of pressure in the latter will therefore lower the mercury column and change the position of the float, thus causing the auxiliary valve to open earlier and allowing more steam to be withdrawn from the engine cylinder. Conversely, if the pressure in the heating system rises, the mercury column will also rise and the float in its new position will open the pilot and exhaust valves later so that less steam will be withdrawn. The middle position of the float corresponds to a horizontal position of the short link connecting the upper end of the float rod with a small crank, and the motion of the latter will thus be the same whether the float rises or falls. The crank will therefore be in the extreme left

position for the middle position of the float, and in the extreme right position for either the highest or lowest position of the float. This crank rocks an eccentric pivot upon which is mounted the double-armed lever operating the small pilot valve. These levers are moved by eccentrics keyed to the lay-shaft.

The operation of the whole mechanism will be clear from a study of the series of indicator cards reproduced in Fig. 8. Starting with the highest float position, the point of opening of the auxiliary exhaust valve moves more and more towards the left while the float falls. This continues until the float reaches its middle position, for which the cut-off in the engine cylinder determined by the load is so short that hardly any steam can be withdrawn during expansion. (See cards No. 2 and 1.) The regulating mechanism follows the change of cut-off. If much heating steam is required when the engine is operating with small loads the float



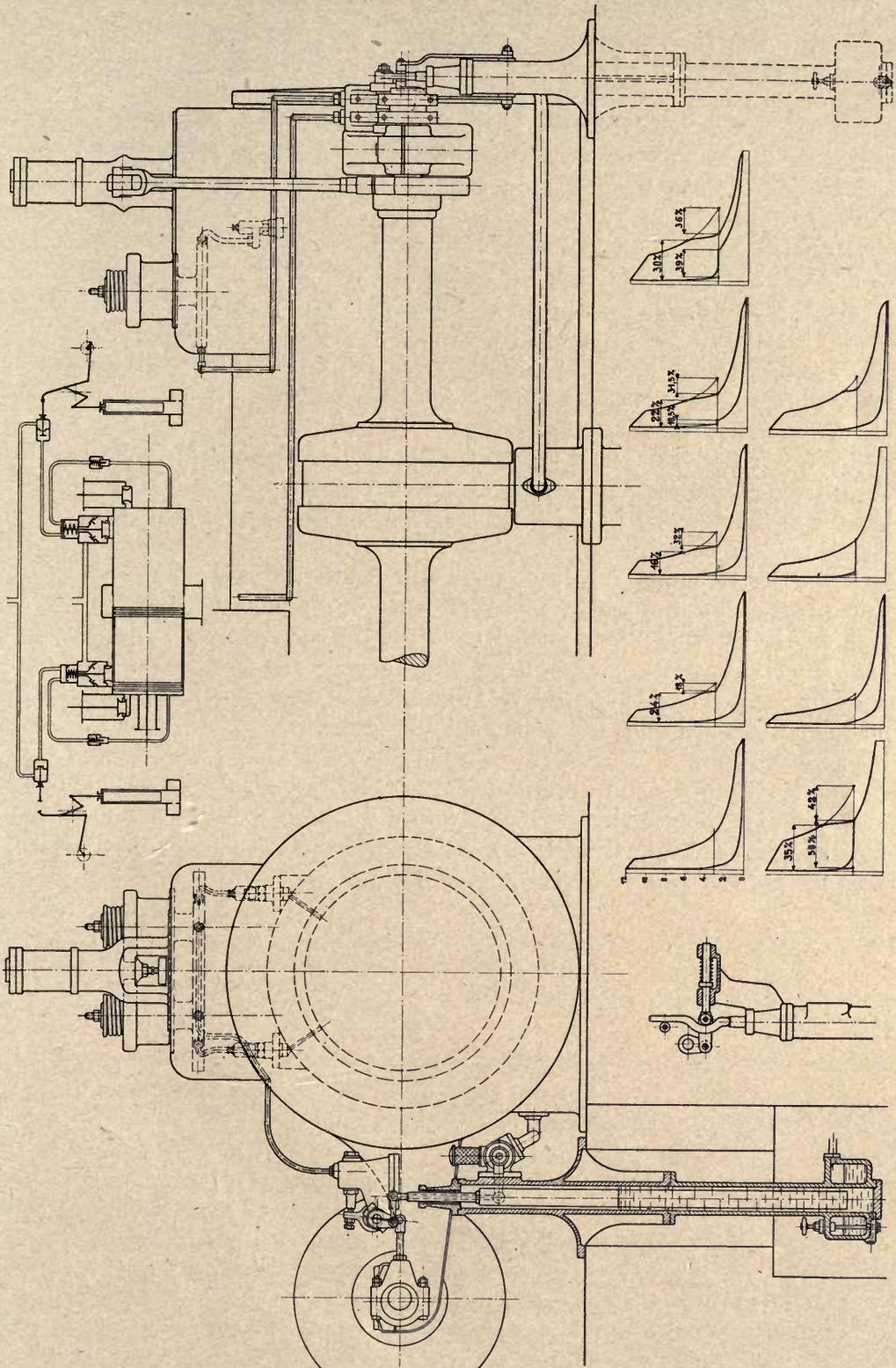


Fig. 8.

will fall still further, the small crank again moves towards the right; and, since no more steam is available during expansion, an arrangement comes into play by which steam is withdrawn during compression. This is done by raising the back pressure and therewith the compression line, by admitting air into the condenser through a snifting valve actuated by a connecting link from the upper end of the float. The compression steam then soon attains the heating pressure and escapes through the still open auxiliary exhaust valve, and past its check valves (see diagram 8).

If much steam is required while the engine is running with heavy loads, then withdrawal occurs during both expansion and compression, as is shown in diagrams 4, 5 and 6. The cut-off in this case is late enough so that even for the lowest float positions steam will be withdrawn during expansion.

The diagrams in a general way show that the action of this mechanism tends to produce the smallest possible loss due to incomplete expansion. Instead of using a crank mechanism for operating the small pilot valves, a cam may be fitted on the upper end of the float rod which acts upon a spring-loaded roller and thus adjusts the position of the fulcrum of the double-armed lever. This combination has the advantage that by properly designing the cam profile any desired dependence between float travel and exhaust valve timing may be realized.

In order to obtain sufficient valve area for the withdrawal of steam during expansion, each end of the cylinder is provided with two of the automatic exhaust or bleeder valves, each surrounded by a nest of check valves. The end of the lay-shaft carries two small eccentrics which operate the pilot valves through the above mentioned double-armed levers controlled by a common float. The governor on the lay-shaft controls the engine output entirely independently of the heating requirements.

So far the problem of withdrawing steam for heating purposes has been solved mostly by installing a tandem engine with a counterflow high pressure and unaf-flow low pressure cylinder, the heating steam being taken from the receiver as was described above.

#### 4. The Una-Flow Rolling Mill Engine.

Much credit for their work in this field is due to the firm of Ehrhardt & Sehmer, who originated the design shown in Fig. 1. The latter is noteworthy for the use of valve gear of the Zvonicek type, which has the advantage of ample valve opening at short cut-offs as well as a large range of admission without excessive valve lifts at late cut-offs. The governor adjusts the cut-off by moving the eccentric strap which carries a cam profile at its upper side for the eccentric rod roller to work upon. For rolling mill engines a maximum cut-off of 50 to 60% is absolutely essential. This is easily obtainable with the Zvonicek gear, the only disadvantage of which is its complication, although this has never proved to be a source of complaint. The single stage una-flow engine gives considerably more power than the tandem compound and it will pull through where the latter would stall. This feature is highly appreciated by rolling mill engineers on account of the varying resistance of the rolls, and is the main reason for the rapid introduction of the una-flow engine in rolling mill practice. This preference has even led to the replacement of several old tandem cylinders by cylinders of the una-flow type.

Fig. 2 shows a flywheel rolling mill engine of medium size built by Ehrhardt & Sehmer. The engine has Stumpf valve gear, and the condenser air pump is driven by the tail rod.

Figs. 3 and 4 show the cylinder of a larger una-flow rolling mill engine with Zvonicek valve gear also built by Ehrhardt & Sehmer.

Fig. 5 shows an ordinary tandem reversing rolling mill engine built by Ehrhardt & Sehmer.

The three pairs of cylinders act on three cranks set at  $120^\circ$ , which arrangement requires less maximum admission than cranks at  $90^\circ$ . This shorter cut-off allows of greater expansion during the rolling process. The crank shaft consists of three similar pieces coupled by flanges, so that any one of them may be easily replaced in case of failure. The eccentric shaft is carried on the frame and is driven from the crank shaft by means of spur gears. This allows of the use of smaller eccentrics, renders the valve gear more accessible on top of the engine frame and brings the center lines of the units closer together.

The piston valves are arranged on top of the cylinders to one side of the center lines in such a way that the high and low pressure valves of one tandem unit are in line and are both driven by the same Stephenson link gear. The latter has

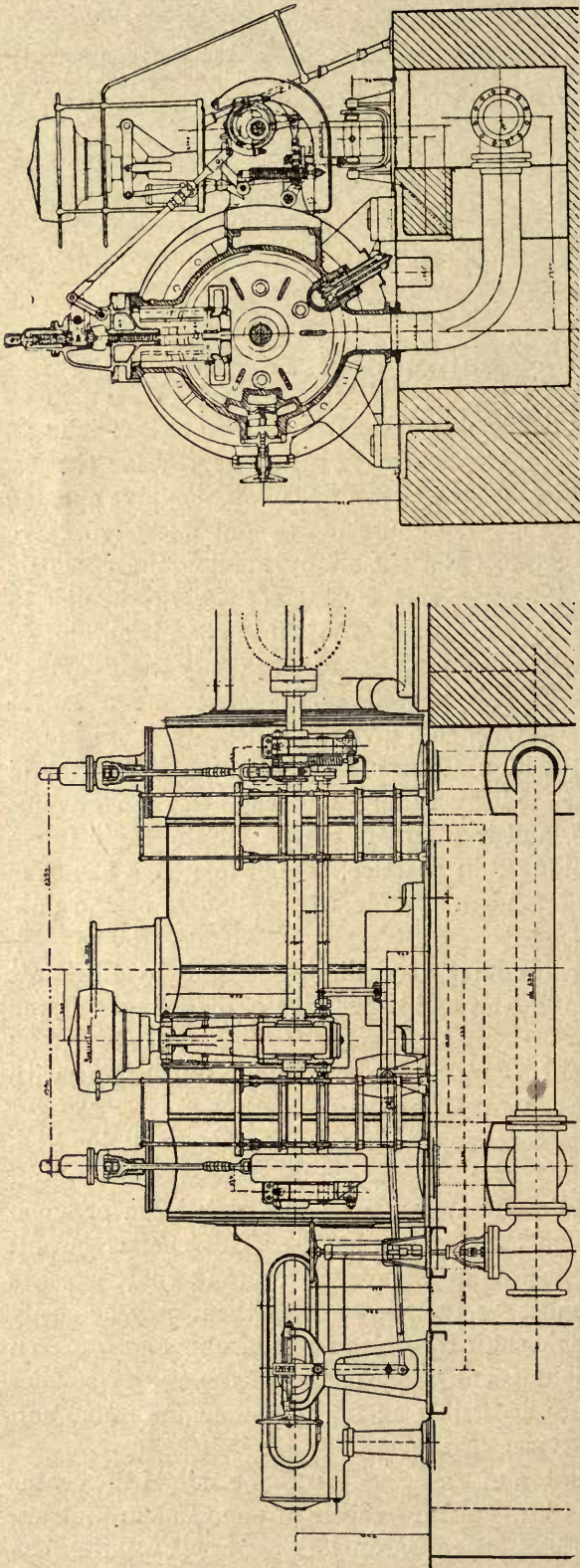


Fig. 1.

crossed eccentric rods as is usual in rolling mill practice. A stop valve is provided on each of the six cylinders, these valves being operated by an auxiliary power cylinder which at the same time controls the position of the Stephenson link in such a manner that for long cut-offs the steam is throttled, while for short cut-offs the stop valves are fully opened. The stop valves of the low pressure cylinders thus allow a certain amount of steam to accumulate in the receivers when stopping the engine.

The problem was to adapt this very satisfactory design for use with una-flow cylinders while retaining as far as possible all its valuable features. This was a change which it would pay to undertake, since three cylinders with their distance pieces, valve gear and accessories could be dispensed with. The driving parts of course must be strengthened to take the higher piston loads of the una-flow engine. Such a design by Ehrhardt & Sehmer is shown in Figs. 6 and 7. The general structure, i. e. frame, valve gear, and the use of piston valves has been retained. The triple arrangement of this engine, as in the previous case, will also give the advantage of early cut-offs and long expansions during rolling. To this end the maximum cut-off of the valve gear is made somewhat short, but in order

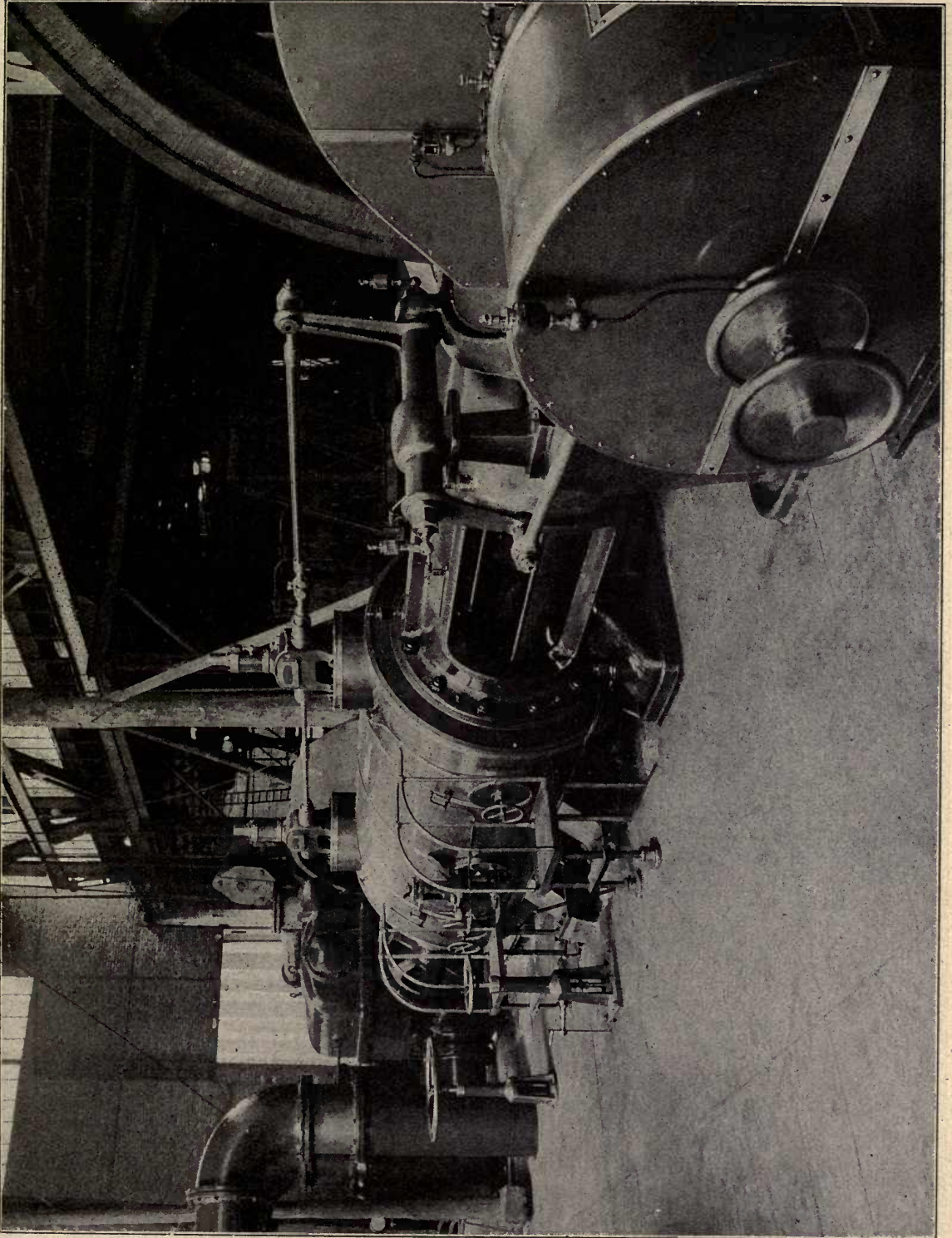


Fig. 2.

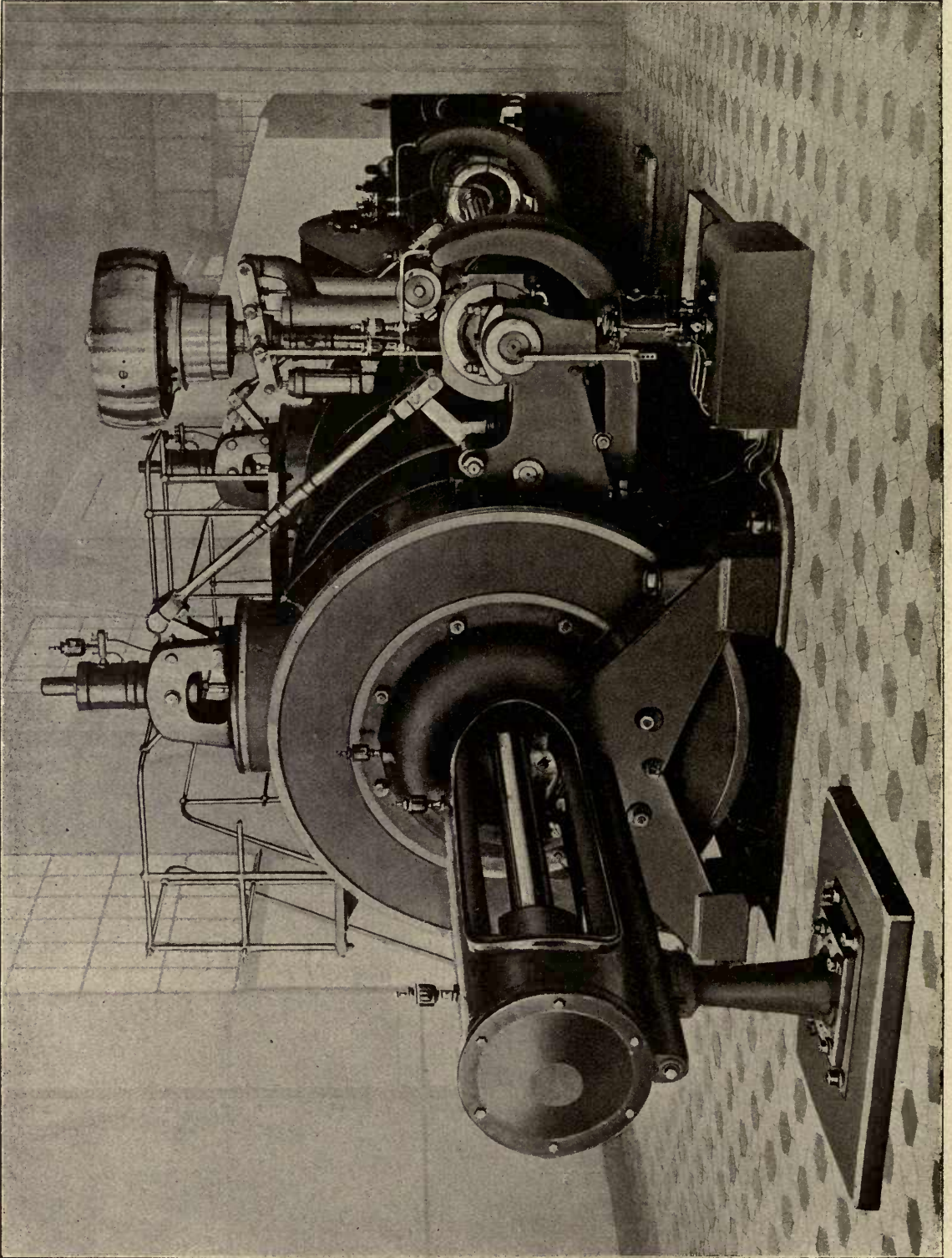


Fig. 3.

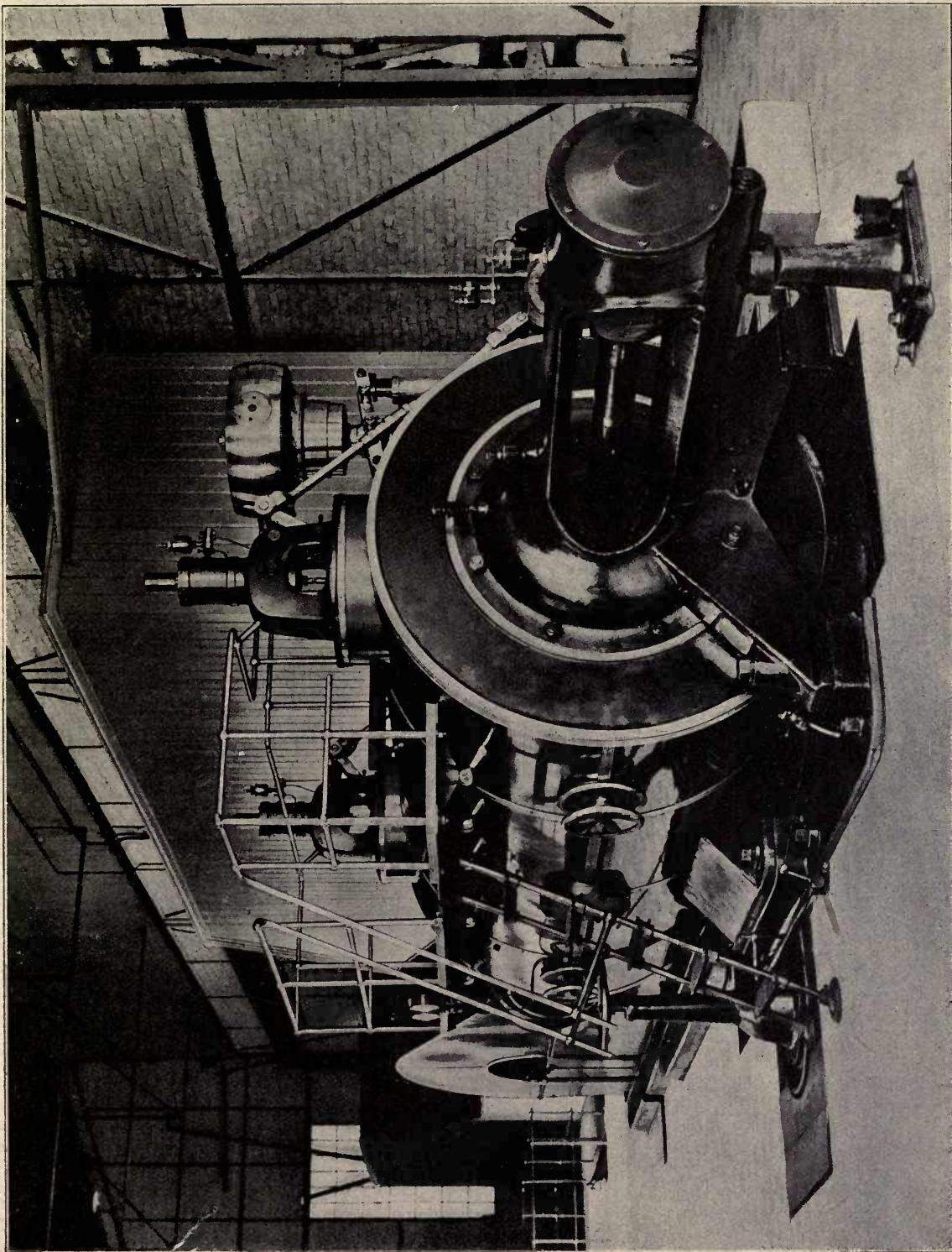
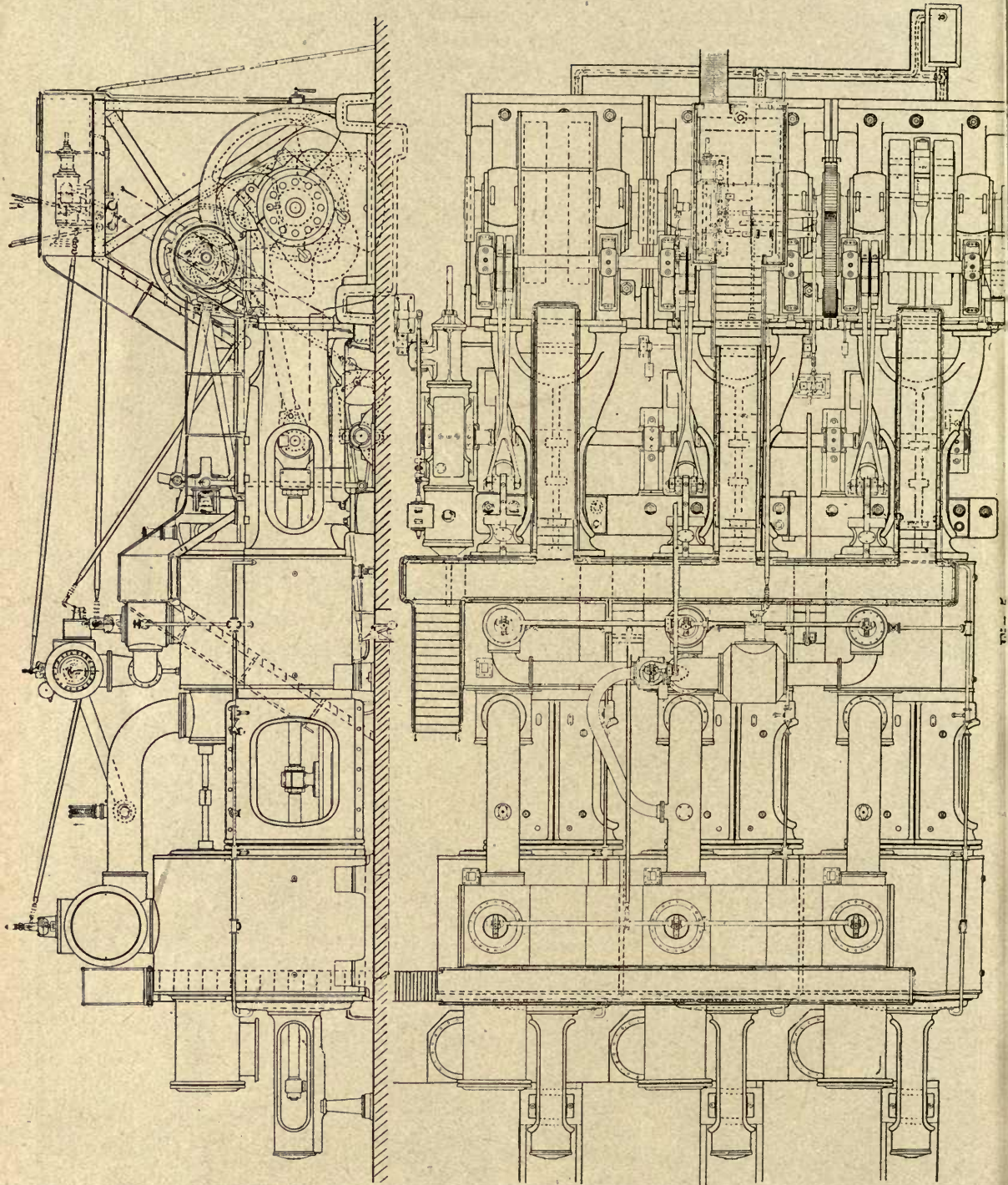


Fig. 4.





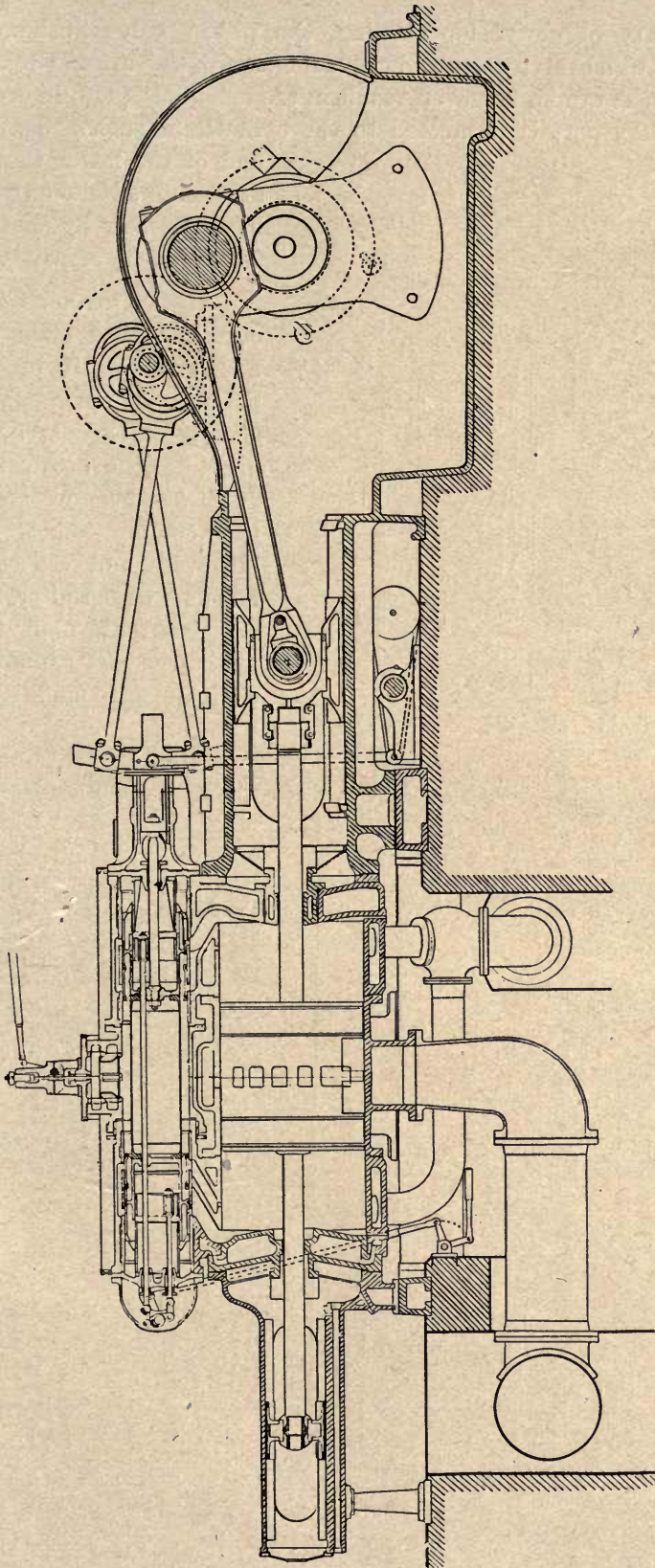
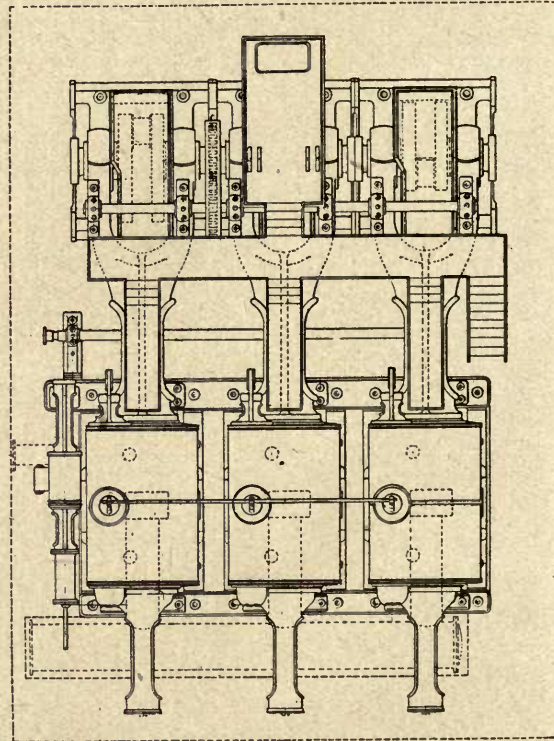
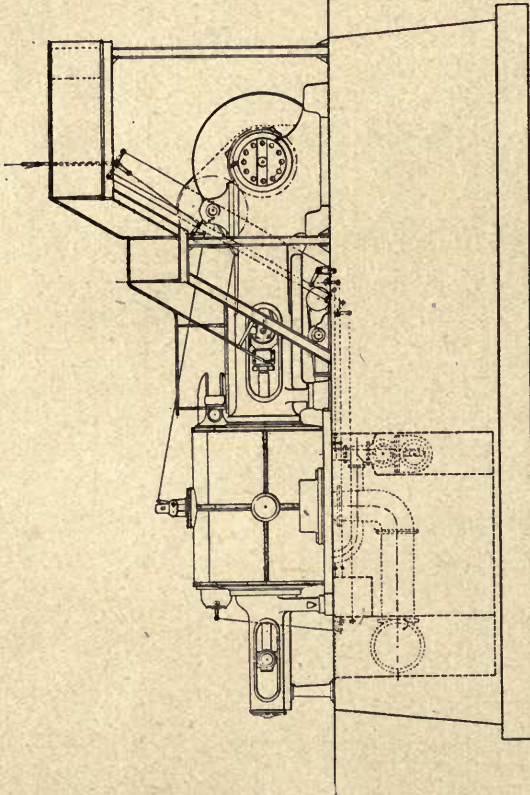
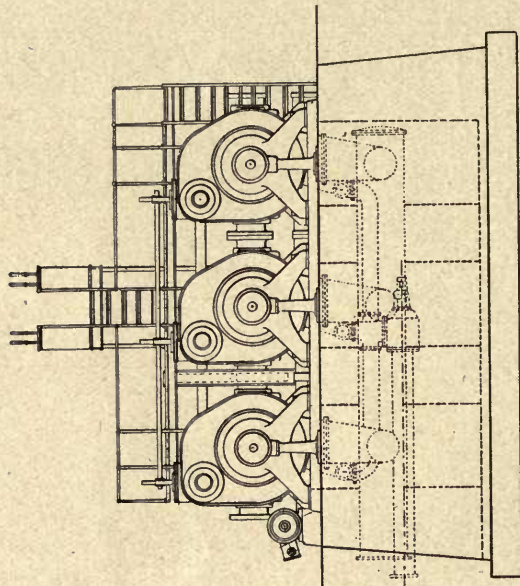


Fig. 6.

to insure plenty of power for starting, the piston valve bushing contains an auxiliary port which gives a considerable increase of cut-off and reduction of lap. This arrangement would, however, result in too much lead; and in order to prevent this the auxiliary port is connected to the cylinder at such a distance from the end of the latter that at the time of steam admission the port has been overrun by the piston and is straddled by a pair of rings.

Fig. 7.

If for instance the maximum cut-off of the main valve is 35% and the cut-off of the auxiliary port 70%, then at slow speeds shortly after starting, or when gripping the ingot, the cut-off of 70% will be effective. As soon as the engine comes up to speed, however, and especially when it begins to race after the passage of the ingot through the rolls, the auxiliary port cannot supply sufficient steam to make itself noticeable,



and the cut-off falls to practically 35%. A considerable saving of steam and increased safety of operation are the result. The limitation of the maximum cut-off of the main valve has the advantage that for early cut-offs the port openings are considerably improved, which is especially important in view of the essentially unfavorable valve opening consequent on the use of crossed eccentric rods.

The use of a piston valve with a large exhaust lap, in combination with the link valve gear, permits of a reduction in the length of compression. The same purpose is served by an auxiliary valve mounted in the main piston valve, by means of which the compression may be reduced or almost entirely eliminated by an adjustment made from the operating platform.

Each cylinder is fitted with a separate stop valve for throttling or cutting off the steam supply from the platform, if operating conditions require it.

The throttling which takes place when running with late cut-offs permits of gentle and gradual starting of the engine. The steam must in fact be throttled to a greater extent in a una-flow engine owing to its greater starting torque as compared with that of a tandem compound. The steam consumption during starting will therefore be correspondingly less. Even with such throttling, the early maximum cut-offs used in this triple engine will produce appreciable expansion.

If the ingot should stall the engine, it is a simple matter to exhaust the steam within the cylinders by reversing the gear; and on again admitting steam, the ingot will be freed from the rolls. The above described valve gear will therefore safeguard the operation of the engine even against such eventualities. Separate auxiliary exhaust ports are not necessary since the inlet ports are used for this purpose.

The piston valves are preferably designed with inside admission. The steam space between stop valve and piston valve should be made as small as possible. A comparison between this una-flow rolling mill engine and a tandem com-



Fig. 8.

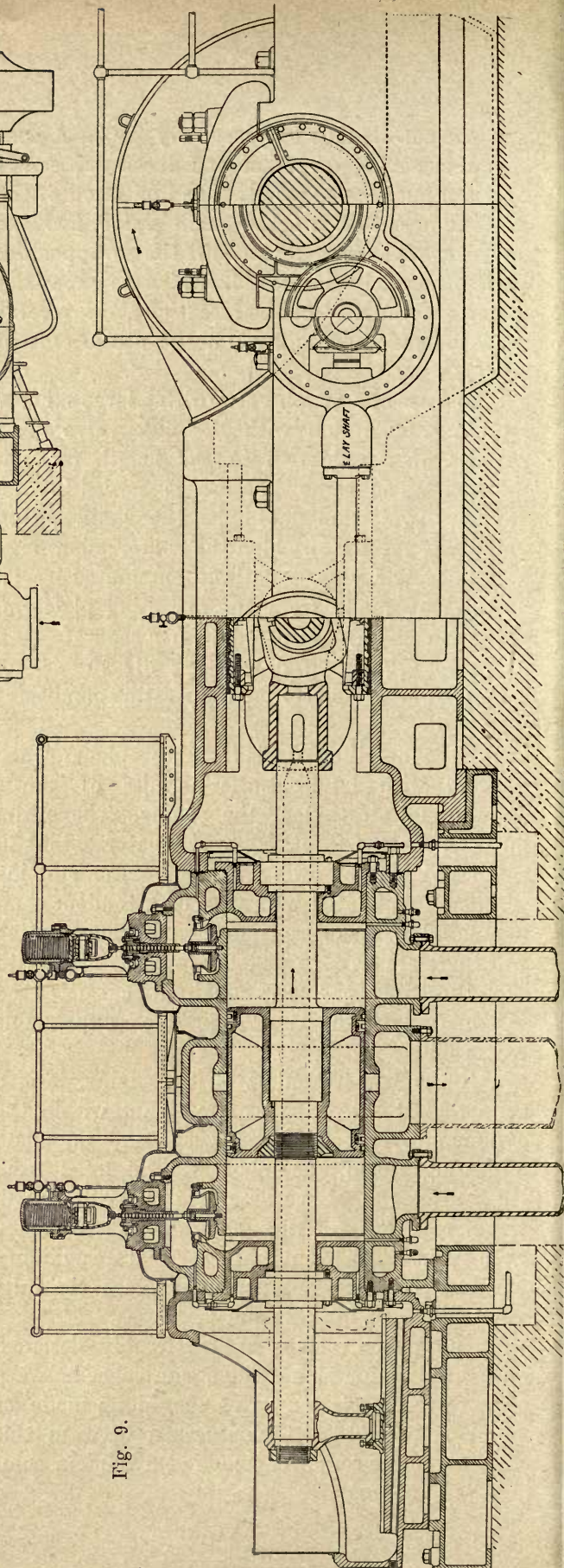
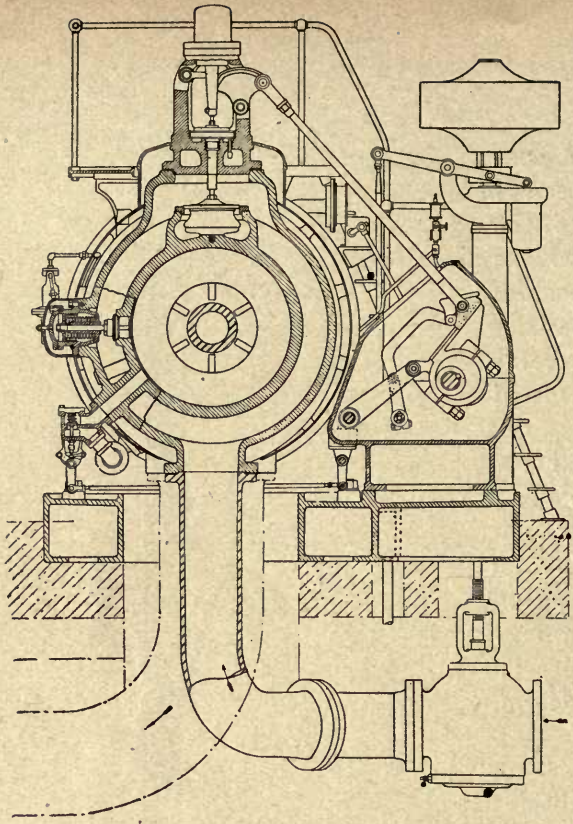
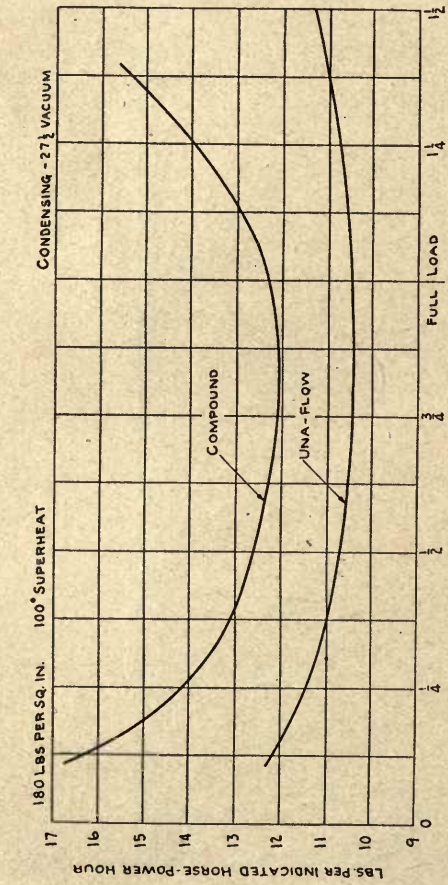


Fig. 9.

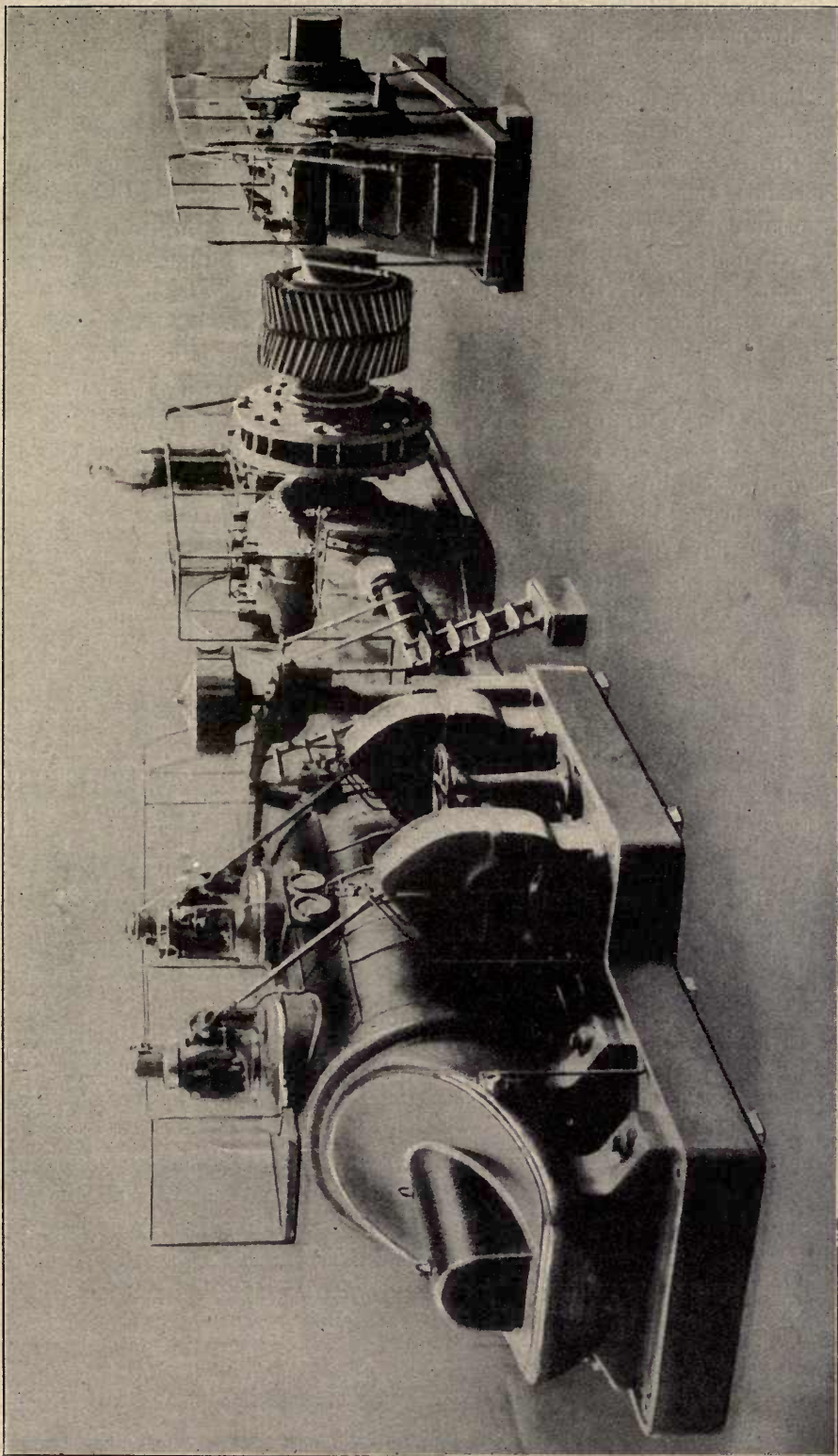


Fig. 10. Una-Flow Rolling Mill Engine built by the Mesta Machine Company Pittsburgh.

pound for the same purpose will demonstrate the fact that considerable simplification, cheaper construction and a reduction in floor space are attainable with this design. Such an engine is also essentially more powerful.

The best engine for rolling mill service is the one which consumes the least steam during the comparatively long and frequent periods of idling. The claim made by Ehrhardt & Sehmer that the una-flow rolling mill engine is the only one which satisfies this condition is justified, since it alone has a theoretically correct no-load diagram and the least no-load steam consumption owing to the una-flow exhaust, to the long compression and the comparatively large inlet areas in consequence of the rather early maximum cut-off.

In compound engines the steam distribution becomes very poor when using early cut-offs below 20%, and it is advisable to use the throttle instead, to adjust the output to the load. In contrast to the unfavorable changes of exhaust lead and compression in the compound engine, these exhaust phases are always the same in the una-flow engine, since they are determined by the exhaust ports. The no-load diagram must accordingly always be correct.

In Fig. 8 is reproduced a series of continuous indicator diagrams taken from a flywheel una-flow rolling mill engine, which shows clearly the no-load cards as well as the rapid succession of no-load and full load cut-offs, thus demonstrating the excellent governing characteristics of the engine. This of course applies equally to the reversing engine.

A very interesting design of a flywheel una-flow rolling mill engine, 40 × 48". 110 R. p. M. max, built by the Mesta Machine Co., Pittsburgh Pa., is shown in Fig. 9 and 10. The power of the engine is transmitted by spur-gearing on the roller shaft. The live steam enters below into the jackets on the ends of the cylinder barrel, feeding also the hollow head covers. The exhaust belt is separated by two neutral divisions from the jacketed ends of the cylinder. The steam enters the cylinder through resilient poppet valves placed on the cylinder barrel. The hollow piston is carried by a heavy hollow piston rod, supported by the crosshead and a slipper. A common governor controls the cut-off by shifting a small crosshead on the operating eccentric. From this crosshead the motion is transferred by a rod with cam and roller on the inlet valves.

The whole design is heavy, strong, reliable and especially adapted for rolling mill work, and all precaution is taken as by safety valves, draining valves, railing, stairs, lagging, enclosures a. s. f. for securing best efficiency and maintenance of the engine.

Attention may be called to the comparatively flat steam consumption curve (Fig. 9) for the una-flow engine, which not only shows a lower steam consumption than the compound engine, but also a more nearly uniform steam consumption over wide ranges of load. This latter feature especially recommends the una-flow engine for rolling mill service, where great and sudden variations of the load are the rule.

## 5. The Una-Flow Hoisting Engine.

### 1. For Condensing Service.

The una-flow engine is suitable for use as a hoisting engine if means are provided to eliminate the compression during the periods of starting and stopping, in order to facilitate the exact stoppage of the cage. An auxiliary valve (see Fig. 1) may be employed for this purpose, having sufficient lap to reduce the compression to almost nothing when starting or when the cage is being brought into the desired position, while during hoisting the full compression of about 90% is effective. During the hoisting period the auxiliary valve is inoperative as regards the compression and the latter is determined entirely by the piston-controlled exhaust ports of the cylinder. As shown in the diagram of Fig. 2, the compression is respectively about 25, 65 and 90% for cut-offs of 80, 50 and 40%. High economy in the utilization of steam on the one hand, and excellent maneuvering abilities on the other, are thus combined in the best possible manner. When the main inlet valves are slide or piston valves, they may also control the auxiliary exhaust, and the exhaust lap should then be proportioned from the above standpoint.

Figs. 3 and 4 show a design recommended for a small hoisting engine. Instead of the auxiliary piston valve shown in Fig. 1, two poppet valves are provided at the ends of the cylinder, which come into operation only at late cut-offs. This arrangement permits of a considerable reduction of the clearance volume and surfaces.

The valve gear is of the Gooch type and the motion is transmitted to both the inlet and auxiliary exhaust valves by means of a cam mechanism. The valve diagrams for this engine are similar to those shown in Fig. 2. With this construction it becomes possible to run the engine non-condensing for short periods if the exhaust valves and exhaust lap are proportioned accordingly. For this temporary condition it is permissible to use rather small valves with correspondingly high steam velocities.

The force necessary to operate this gear is so very small that reversing and notching up may be carried out by hand, thus dispensing with a power maneuvering

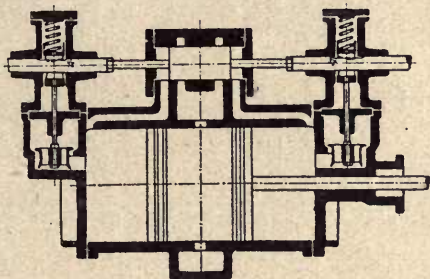


Fig. 1.

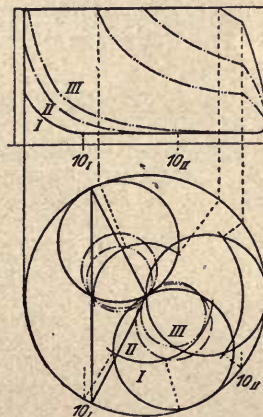


Fig. 2.

cylinder. For this reason it is advisable to use the Gooch valve gear, in which only the slide block and valve rod have to be lifted, instead of the link and eccentric rods.

The four valves may also be operated by means of the ordinary tapered cam gear (Figs. 5 and 6). The cams are preferably arranged so as to give only a small inlet valve lift for cut-offs of 80 to 90%, and to hold open the comparatively small auxiliary valves during almost the whole of the compression stroke. This

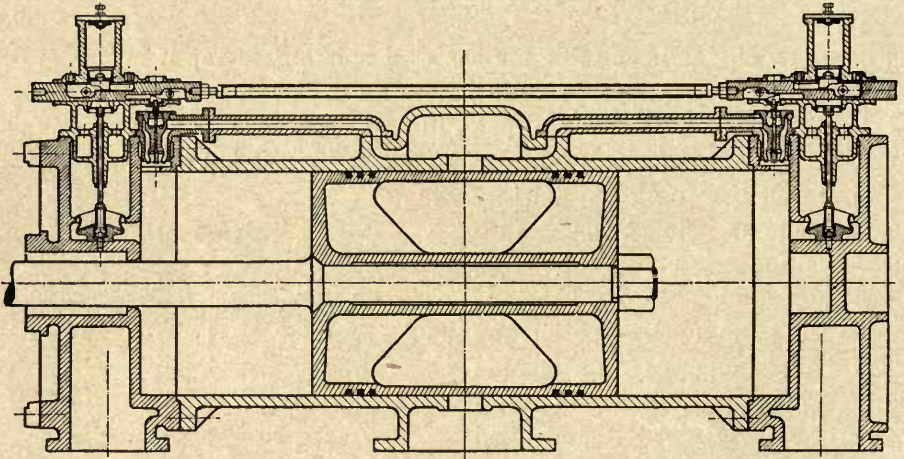


Fig. 3.

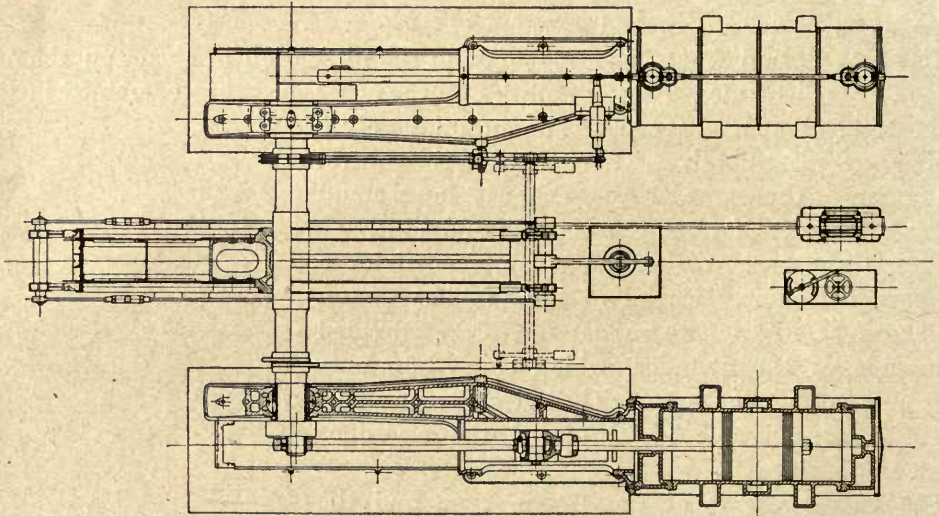


Fig. 4.

enables the cage to be stopped with accuracy in the desired position. A late cut-off is also used at the commencement of hoisting, with the auxiliary valves likewise in action. During the greater part of the hoisting period the cut-off is early and the auxiliary valves are out of action, so that the engine operates as a true un-a-flow engine under the most favorable conditions.

The tapered cam gear may also be operated by hand in most cases without the use of an auxiliary power cylinder. Since the clearance space for 90% com-



pression may be properly proportioned to give sufficient compression for any condenser pressure, the maneuvering of the engine may be freely and easily accomplished without depending on safety devices such as spring-loaded valves to prevent excessive compression.

The condenser air pump should be preferably independently driven.

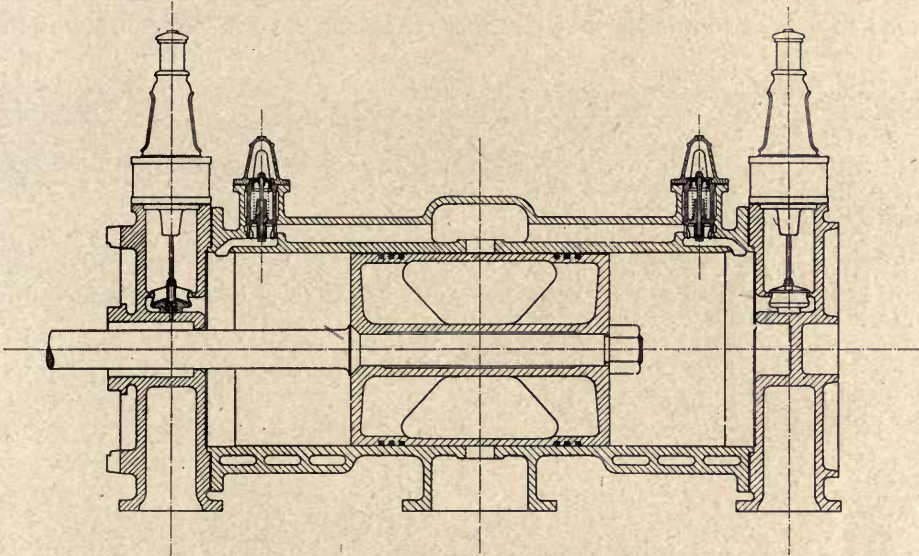


Fig. 5.

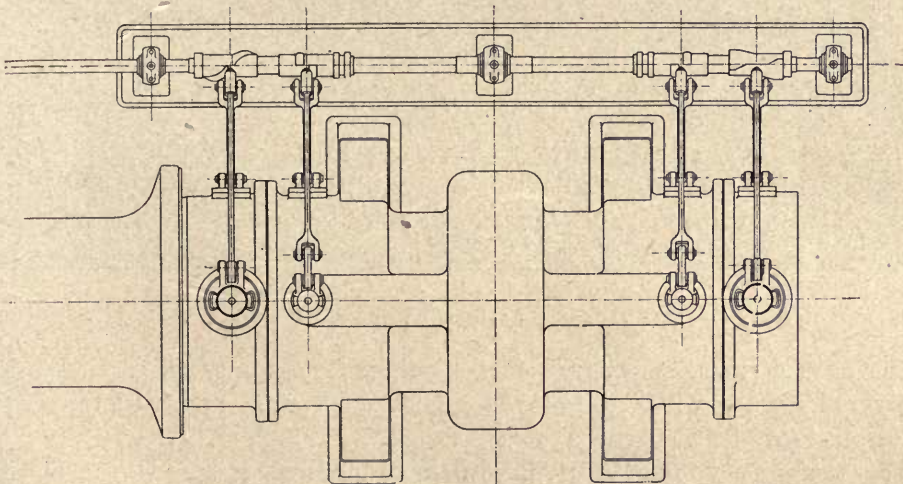


Fig. 6.

## 2. The Una-flow Hoisting Engine, Exhausting to Atmosphere or to a Low Pressure Turbine.

Fig. 7 shows a una-flow hoisting engine for non-condensing service built by the Gutehoffnungshütte Works for the Vondern Colliery, shaft No. 2. The engine is designed to hoist eight tubs of 500 kg net each, from a depth of 600 m, with

a maximum velocity of 20 m/sec. It is fitted with two rope drums each of 6400 mm diameter and 1900 mm width, which are adjustably coupled for hoisting from different levels. The engine at present works non-condensing, with steam of 8 at. gauge pressure. Both cylinders have a bore of 1100 mm and a stroke of 1600 mm. The cylinders are unjacketed plain cylindrical castings supported at their ends on feet resting on base plates. The inlet is controlled by piston valves which are arranged to give a supplementary exhaust while the cage is being brought to rest

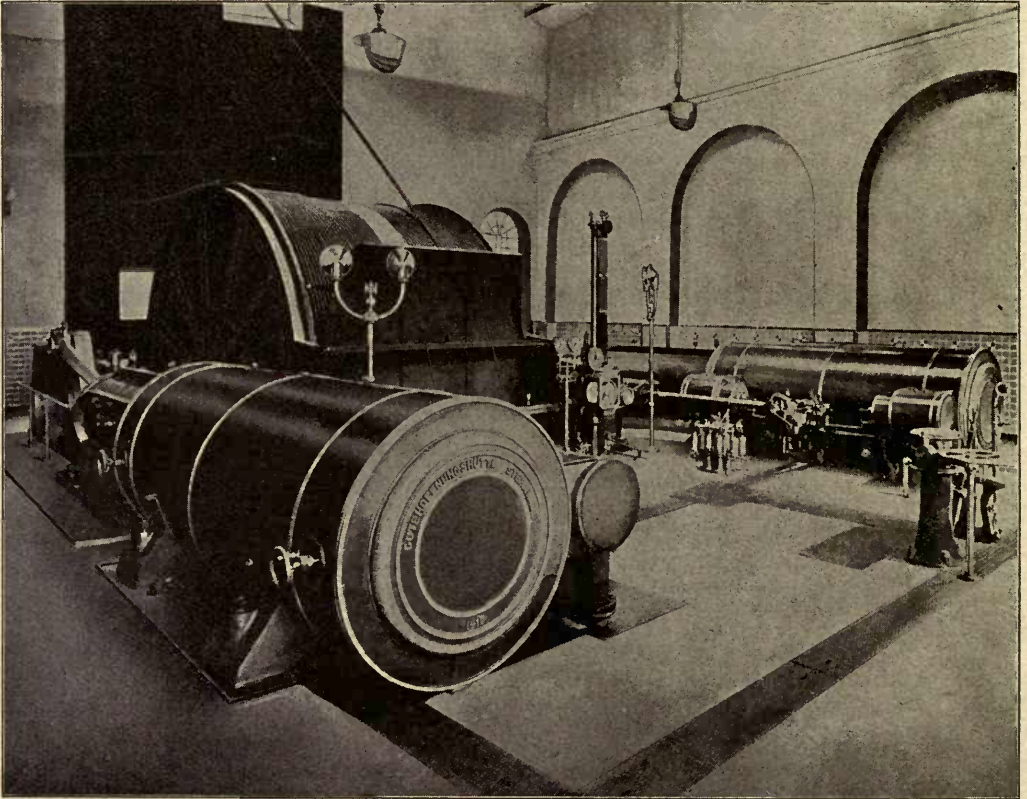


Fig. 7.

and during the first few strokes after starting. The compression is thus almost entirely relieved, thereby rendering possible an exact stoppage of the cage and easy starting of the engine.

The clearance volume is 10% with an additional clearance pocket of 8%. The valves are indirectly operated by tapered cams mounted on a short cross shaft placed at right angles to the cylinder at its middle and driven from the crank shaft by means of bevel gears and a lay shaft. The cams act on pilot valves which control auxiliary pistons coupled to the main piston valves. The tapered cams are shifted by means of the reversing lever without the use of a power cylinder.

This hoisting engine is equipped with a combined depth gauge and safety device of the Gutehoffnungshütte type which controls the hoisting operation from

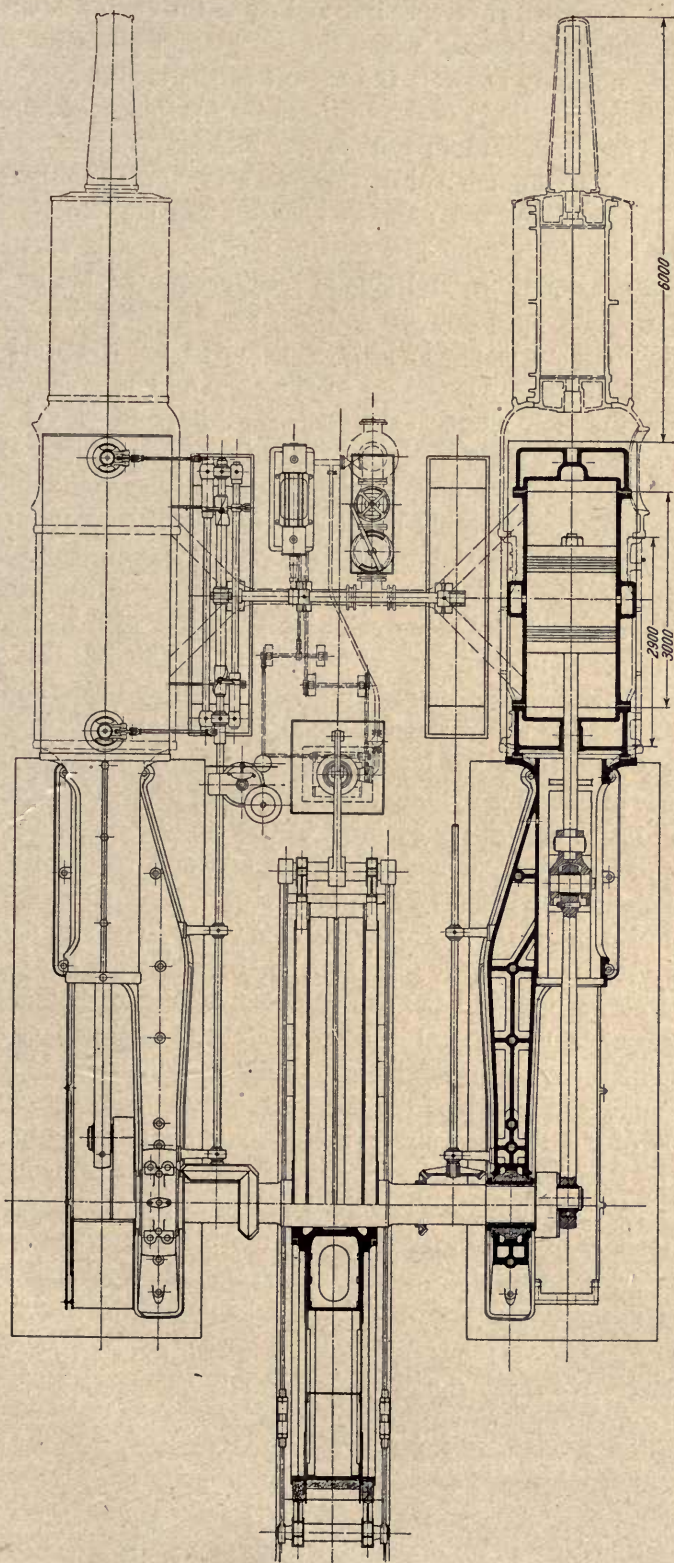


Fig. 8.

beginning to end. It prevents overspeeding and slows the engine down automatically and in a predetermined manner when the cage approaches its stopping place. The safety device not only controls the cut-off as the engine gets under way, but also causes the steam-operated brake to come into action gradually, according to the amount of overspeed, and to release the brake when the speed again falls. If the cage passes its stopping point, the brake is applied with full power. Increased safety is thus imparted to both hoisting and stopping.

The engine has given complete satisfaction as regards service, but not in respect to steam consumption, and this is fully accounted for by the low initial pressure, the large clearance volume and the use of piston valves.

The una-flow engine is particularly well suited for the work of a hoisting engine on account of the direct action of the steam. The greater the number of expansion stages, the more sluggish the engine will be; and conversely, the smaller the number of stages the more lively it will be in its action. For this reason, and also on account of the higher diagram factor, the stroke volume of the una-flow cylinder can be made considerably smaller than that of the low pressure cylinder of a compound hoisting engine, both in respect to stopping the cage and for the accelerating period. In the latter connection it may be mentioned that the una-flow engine will run at higher mean effective pressures with the same steam consumption as the compound engine.

With the una-flow engine there is no need to worry over the maintenance of the compound effect for the various changes of load, or when the engine is temporarily at rest. The radiation losses will also be considerably smaller as compared with those of the four cylinders and receivers of a twin tandem compound. These radiation losses are especially large in the latter since the receiver pressure must be maintained while the engine is temporarily at rest. On the other hand, the una-flow hoisting engine may use more steam for maneuvering.

Apart from its thermal superiority, the una-flow hoisting engine has obvious constructional advantages. In order to make these clear, a comparison has been made in Fig. 8 between a twin tandem compound hoisting engine of usual design having cylinders of 900 and 1400 mm bore by 1800 mm stroke, and a una-flow hoisting engine of the same power, the cylinders of which would have a diameter of about 1250 mm. The length of the una-flow cylinder casting would be 3000 mm as against 2900 of the low pressure cylinder. The overall length of the una-flow engine would be 6 m less than the length of the tandem compound engine. The engine house and the foundation would be shorter by the same amount. Two complete cylinders with valve gear, two distance pieces and two receivers are dispensed with. The oil consumption will be correspondingly smaller and the whole engine will be cheaper, simpler and more reliable, notwithstanding its heavier driving parts.

---

## 6. Una-Flow Engines for driving Air Compressors, Pumps, etc.

The constructional simplification of the una-flow engine is of particular advantage in connection with air compressors, pumps or blowing tubs. Two-stage engines are usually built as cross-compounds, which works out satisfactorily in many cases. The una-flow engine, however, permits of a straight line construction; and although this can also be employed in two-stage engines in a tandem arrangement, it is somewhat inconvenient and has, therefore, not found much favor.

The una-flow engine is of course also suitable for a twin arrangement as shown in Fig. 1. This illustration represents a una-flow pumping engine built by the firm of Gustav List in Moscow for a municipality in Central Russia. The point of importance in this case was reserve power, with first cost as a somewhat secondary consideration. This requirement is satisfactorily met in this engine, since each side is a complete unit and can be operated independently, although with a different flywheel effect. A surface condenser is arranged crosswise underneath the cylinders and either of the latter may be blanked off from it by means of a slip flange, inserted between the connecting flanges. Each cylinder is also provided with an independent change-over valve and exhaust pipe for non-condensing operation. The pumps are placed in a well and driven from the engine tail rod by means of a bell-crank which also drives the condenser air pumps. The surface condenser is cooled by the water delivered by the main pumps, so that no circulating pumps are necessary.

In Fig. 2 is shown an air compressor in which the air and steam cylinders are combined. The steam cylinder is single-acting and the inlet valve is of the single-beat type forged in one piece with the stem. The valve is actuated by a rolling lever mechanism enclosed in a housing and running in oil. This mechanism comprises a rocking spindle operated by the eccentric, which spindle carries a curved lever acting upon one arm of a rolling lever, which in turn opens the valve.

By keeping the whole mechanism running in oil, the wear of the moving parts is almost entirely eliminated. The clearance volume of the steam end is extremely small, since the valve stem may be brought close to the cylinder barrel. An auxiliary exhaust valve is provided to reduce the compression. In order to shorten the cylinder as much as possible, an exhaust lead of 20% is used and the port area is correspondingly reduced.

This large exhaust lead permits of the use of a partial exhaust belt and allows the cylinder and piston to be shortened. The air end is of standard design. The suction valves consist of a split spring steel band or ring covering the suction ports which are drilled in the cylinder flange, and the cylinder head forms the valve guard. The whole cylinder head surface is available for the arrangement of the discharge valves, which is of particular advantage in small compressors.

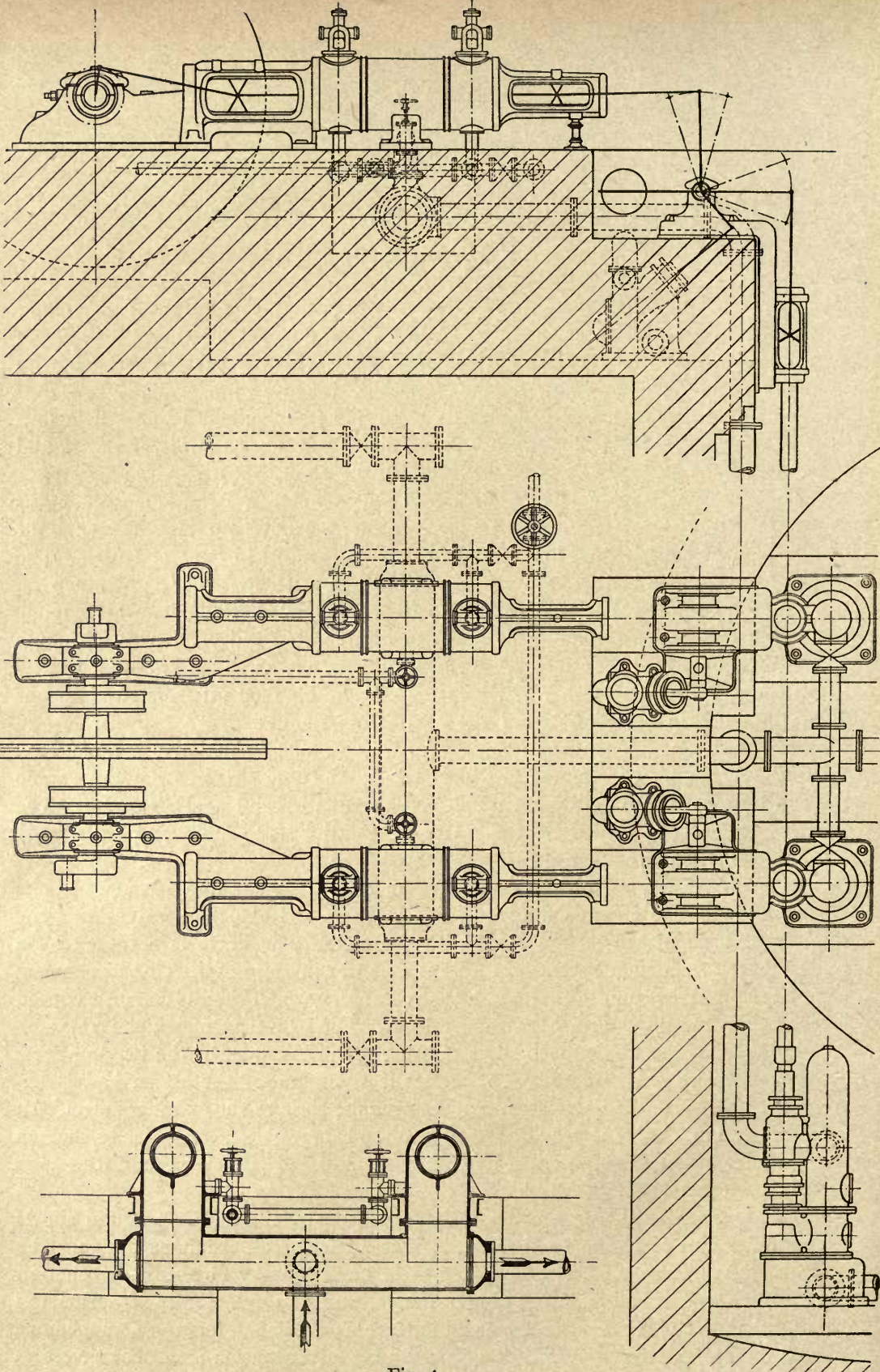


Fig. 1.

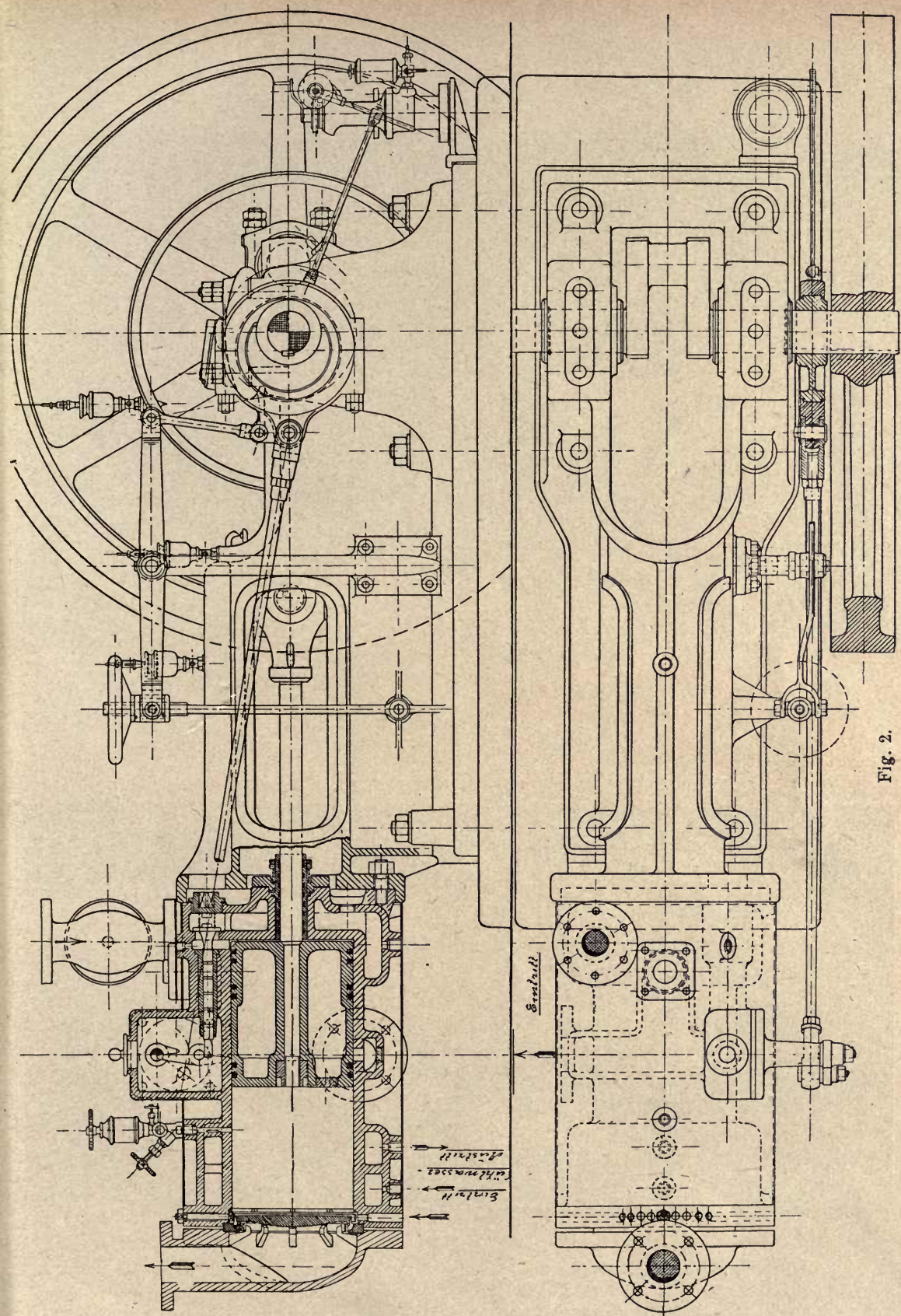


Fig. 2.

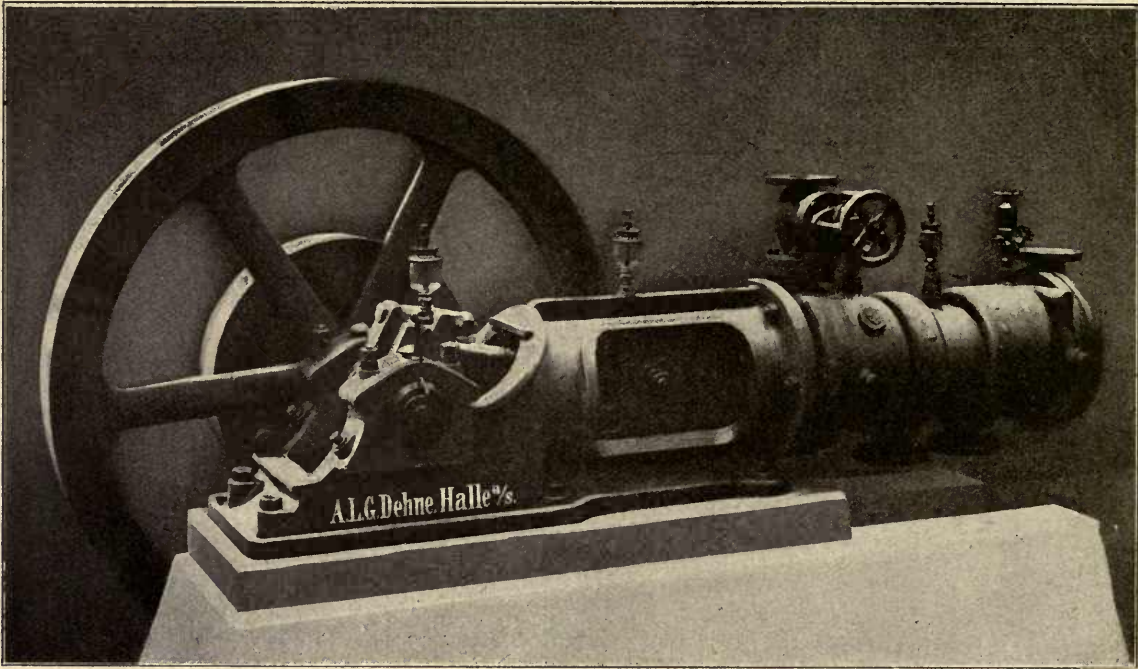


Fig. 3.

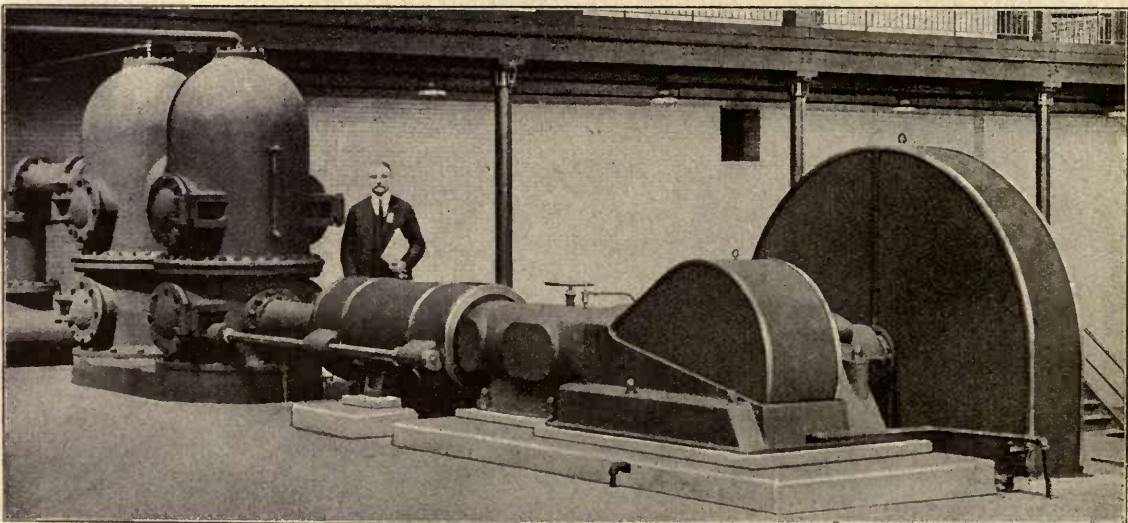


Fig. 5.



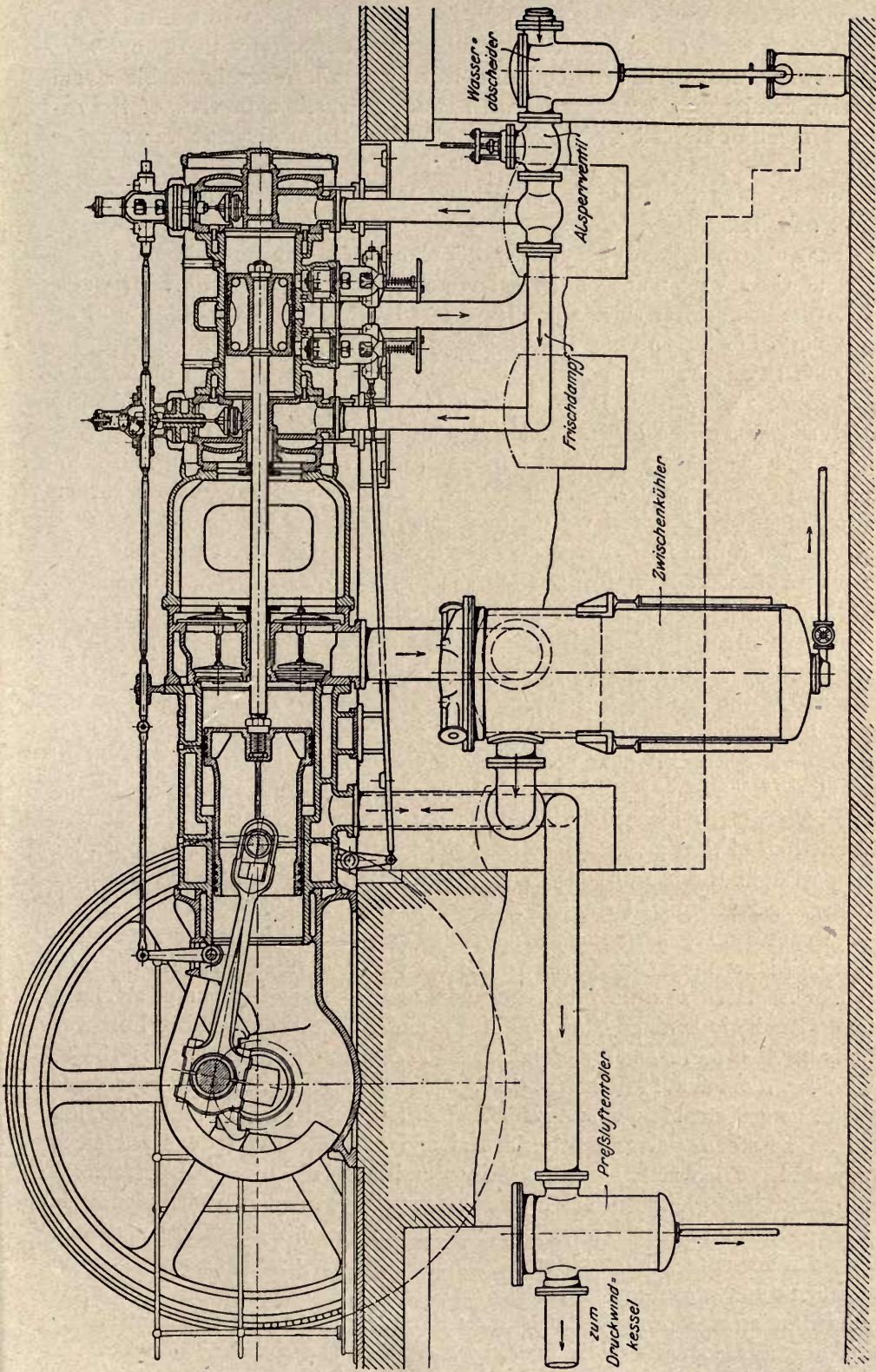


Fig. 4.

zum Druckwindkessel = To compressed air receiver. Zwischenkühler = Intercooler. Absperrenteil = Stop valve.  
 Preßluftentöler = Oil separator. Frischdampf = Live steam. Wasserabscheider = Steam separator.

The discharge valve is also in the form of a split spring steel band mounted in the cylinder head so as to cover the delivery holes communicating with the cylinder. The clearance volume of the air end also is very small. Very favorable steam consumption results may be expected with this construction, in view of the excellent test results obtained with a similar cylinder design given in the chapter on locomobiles.

The cut-off may be changed by buckling the eccentric rod by means of a handwheel and link.

The central exhaust ports half way between the steam and air ends, with the outlet at the lowest point of the cylinder, will make it impossible for water to get into the compressor side. Simplicity, low first cost and accessibility of all important parts are advantages of this design.

One such engine as shown in Fig. 3 has been built by the firm of A. L. G. Dehne, of Halle a. d. S. For larger units a two-crank arrangement would offer certain advantages, one side comprising a standard horizontal or vertical una-flow engine and the other a standard horizontal or vertical blowing tub, air compressor, etc. It would be desirable in this case to arrange the cranks in such a way as to reduce the flywheel weight to a minimum.

Fig. 4 shows a una-flow driven straight line, two-stage air compressor built by the Linke-Hoffmann Works, of Breslau. The cylinders are arranged in tandem, the air cylinder being next to the frame, with a distance piece between the air and steam cylinders. The differential air piston at the same time performs the function of a crosshead. The high pressure stage is at the crank end, and the low pressure stage at the head end of the air piston. The intercooler is placed in the foundation below the air cylinder. The steam valves of the una-flow cylinder are operated by a Stumpf gear and a governor on the crank shaft. Auxiliary exhaust valves are also provided, likewise actuated by a cam mechanism driven from the crankshaft, by means of which the length of compression may be reduced to about one-half of that given by the central exhaust ports. The engine operates condensing without the use of the auxiliary exhaust valves, and their valve gear should therefore be arranged so that it may be disconnected.

A high speed pumping engine built by the Worthington Pump & Machinery Corporation, of New York City, is shown in Figs. 5, 6 and 7. In this case the una-flow cylinder is placed next to the frame; and the double-acting pump, arranged in tandem with it, is connected to the steam end by tie rods running from the pump body to the crank end cylinder head. The steam cylinder bore is  $13\frac{1}{2}$ "', pump plunger diameter 11"', stroke 21"', speed 210 r. p. m., steam pressure 220 lbs/sqin. gauge, steam temperature  $562.4^{\circ}$  F. and total head including suction lift 153 ft. The steam valves are horizontal and are actuated by tapered cams on the lay-shaft, which runs on ball bearings and is driven by spiral gears from the crank shaft. The section of the lay-shaft carrying the cams is shifted endwise by a speed governor so as to control the maximum speed. A pressure regulator acting in a similar manner is mounted at the end of the lay-shaft and governs the engine for constant water pressure. The pump is provided with nests of automatic valves of special design, which are accessible from both sides by means of hinged manhole covers. An interesting feature is the complete enclosure of

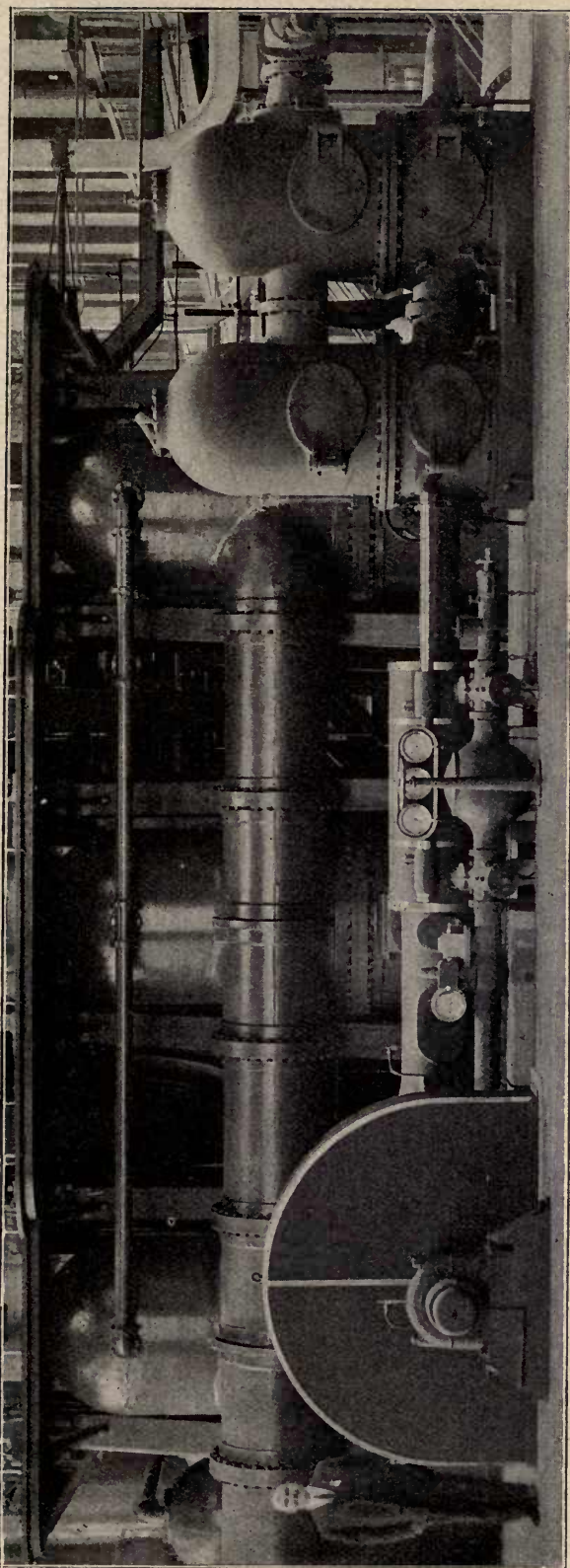


Fig. 6.

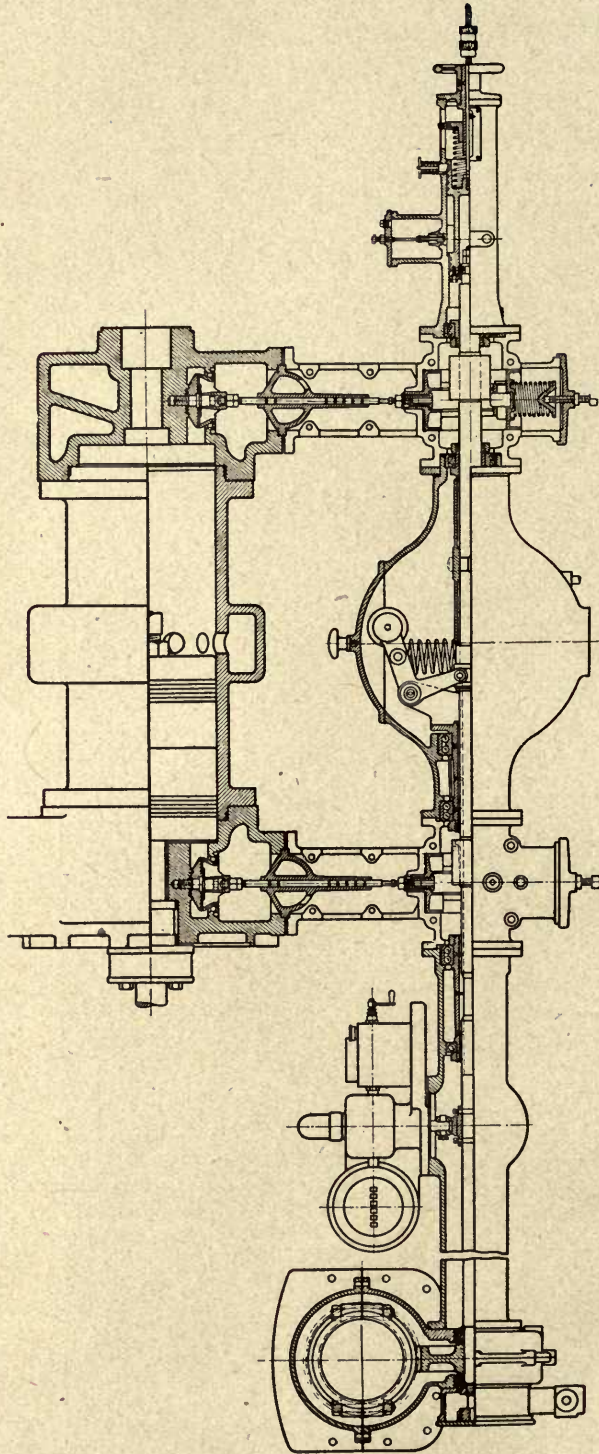


Fig. 7.

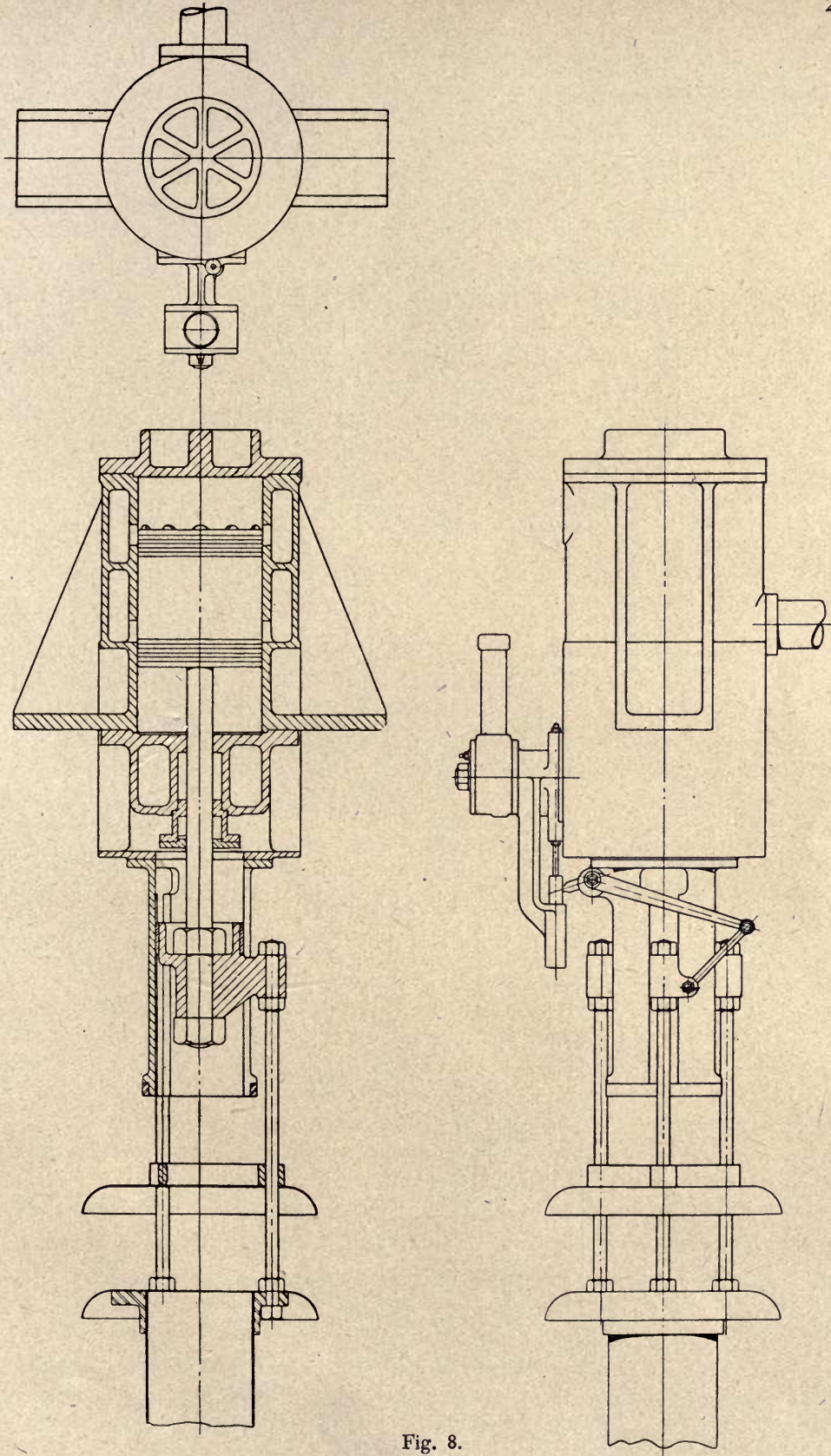


Fig. 8.

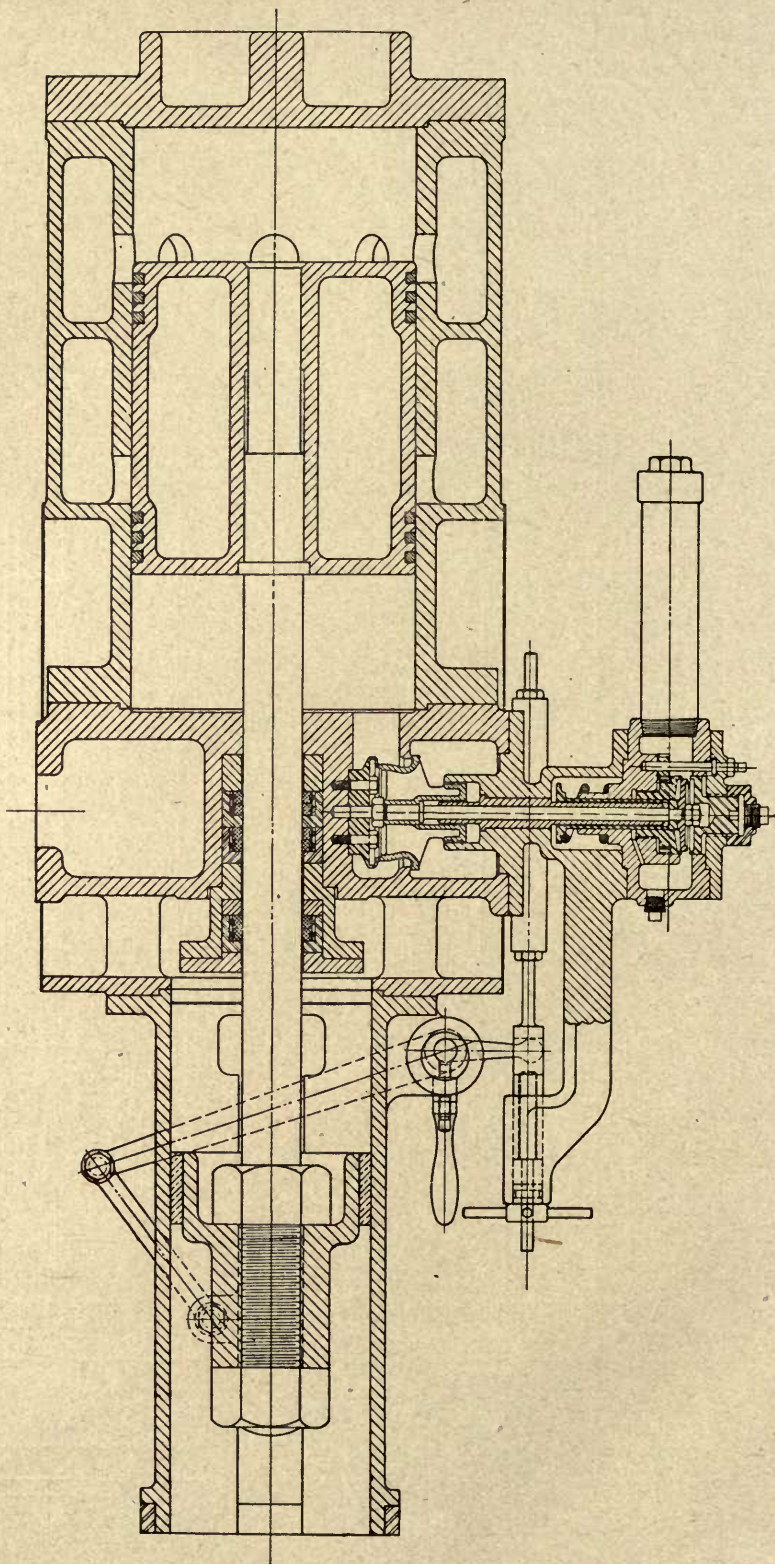


Fig 9.

all working parts, which even extends to the lay-shaft, governor, piston rod, crank shaft and flywheel, so that no moving part is visible. The automatic lubricating system includes all bearings, pins and glands. The engine has proved very satisfactory in service.

In Fig. 8 and 9 is shown the application of a una-flow cylinder to a reciprocating tube pump, an indicator card of which is reproduced in Fig. 10. This type of pump is being developed by the Humphrey Gas Pump Company, of Syracuse, N. Y., and consists of a tube provided with a foot valve, which is reciprocated in a well or casing by direct attachment to the piston of a una-flow cylinder mounted at the well head. The weight and energy of the tube and its contents are utilized in connection with the functions of the power medium, which in this machine is steam, by permitting the latter to be used expansively. This is in marked contrast to the usual type of direct-acting well pump, where late cut-offs are necessary, thus resulting in excessive steam consumption.

The cylinder has a bore of 12", with a stroke of approximately 10", the speed being from 150 to 200 cycles per minute. The cylinder is of course single-acting and its upper end

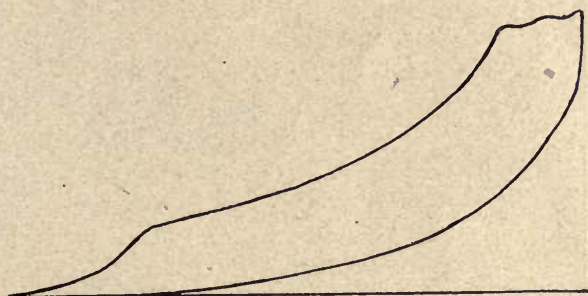


Fig. 10.

is closed to form a cushion chamber which serves to retard the reciprocating parts and tube towards the end of the upstroke when the exhaust ports are uncovered, while the water continues to move through the tube. Hence practically the whole of the kinetic energy of the moving parts is stored, and thus becomes available for accelerating them on the downstroke. This energy, as well as that due to the fall of the tube, is then used in the compression of the residual steam in accordance with the una-flow cycle. While this is taking place the water is still in motion relatively to the tube, and this continues until admission begins at the commencement of the upstroke, when the tube is again accelerated and the foot valve closes.

The valve gear consists of a swinging link and lever operated from the cross-head to which the rods carrying the tube are attached. Since the length of the stroke is not positively determined by mechanical means, a delayed action of the inlet valve is provided for by causing the valve gear lever to operate a pilot valve, which in turn controls the admission and release of steam behind a piston forming part of the double-beat inlet valve. The latter is of cast iron and works on a resilient lower steel seat. The valve is cushioned both on opening and closing by a double-acting adjustable oil dash pot, which is insulated as far as possible from the valve chest cover. This valve gear has proved satisfactory and quiet in action, but contains a somewhat large number of parts. A direct acting piston valve mechanism has also been built. The volumetric efficiency is considerably over 100%.

A great una-flow blowing engine, built by the Mesta Machine Co., Pittsburgh Pa, is shown in Fig. 11.

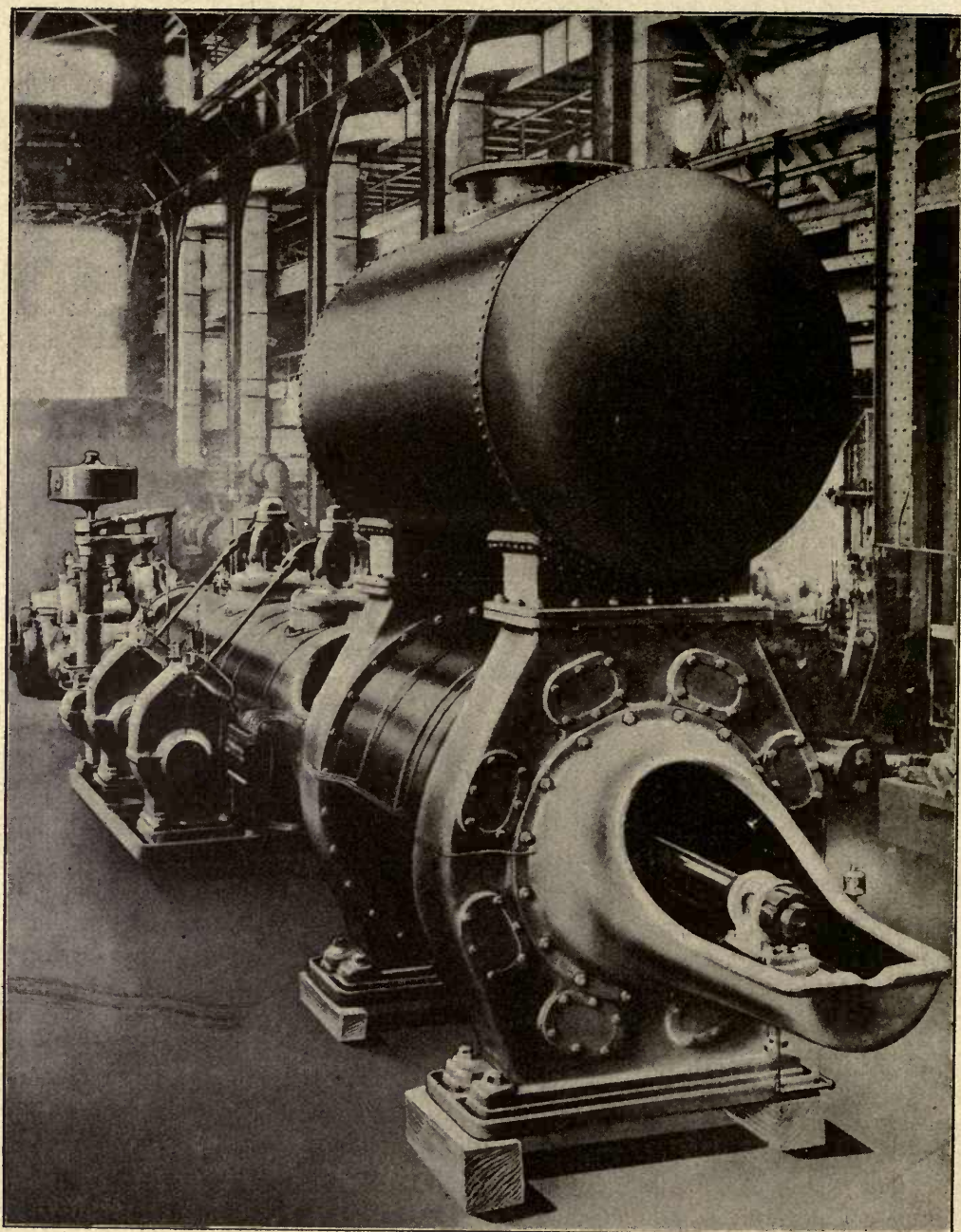


Fig. 11. Una-Flow Blowing Engine built by the Mesta Machine Company Pittsburgh.



### III. The Una-Flow Locomotive.

Fig. 1 shows a superheater freight engine which was built for the Moscow-Kasan Railway by the Kolomna Engine Works, of Kolomna, near Moscow. This was the first locomotive built upon recommendation of Mr. Noltein, the manager of the railway, and was fitted with una-flow cylinders designed by the author. They were originally fitted with small auxiliary exhaust valves which were removed later, so that the engine now operates as a true una-flow.

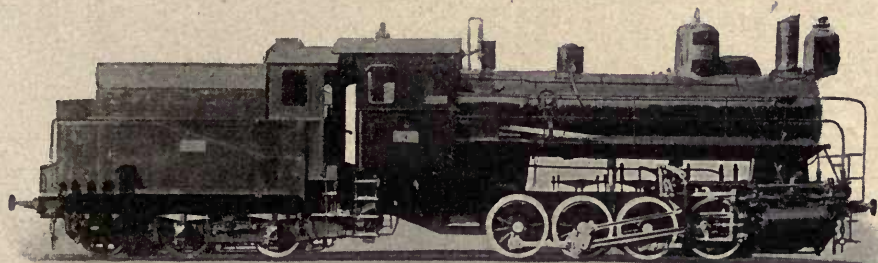


Fig. 1.

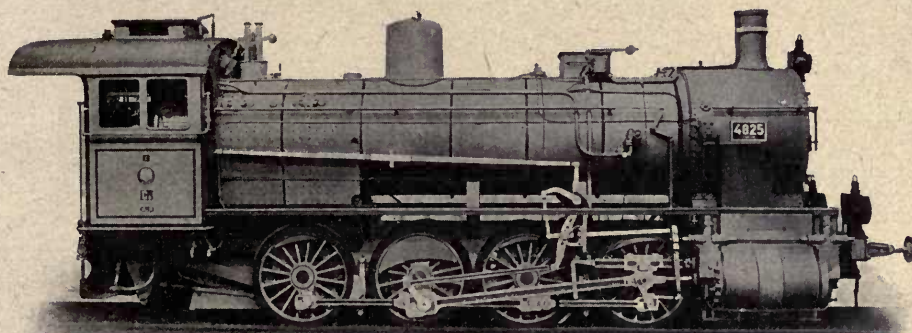


Fig. 2.

Fig. 2 shows one of a pair of superheater freight locomotives built for the Prussian State Railways by the Stettiner Maschinenbau-Aktiengesellschaft „Vulkan”. In Fig. 3 is given a longitudinal and cross section of the locomotive, as well as a longitudinal section of the cylinder. Figs. 4 and 5 show the simplicity of the cylinder and valve gear parts. All the experience obtained with the above-mentioned Russian locomotive was utilized in this design. These engines were put in heavy continuous day and night service and proved so successful that a number of engines of the same design were ordered.

The valves and live steam spaces are arranged in the heads while the exhaust ports and exhaust chamber or belt are at the middle of the cylinder. This strict separation of hot live steam from the cold exhaust steam is not only advisable for thermal reasons but also from an operating standpoint, since the parts exposed to high temperatures cannot affect the operating conditions of

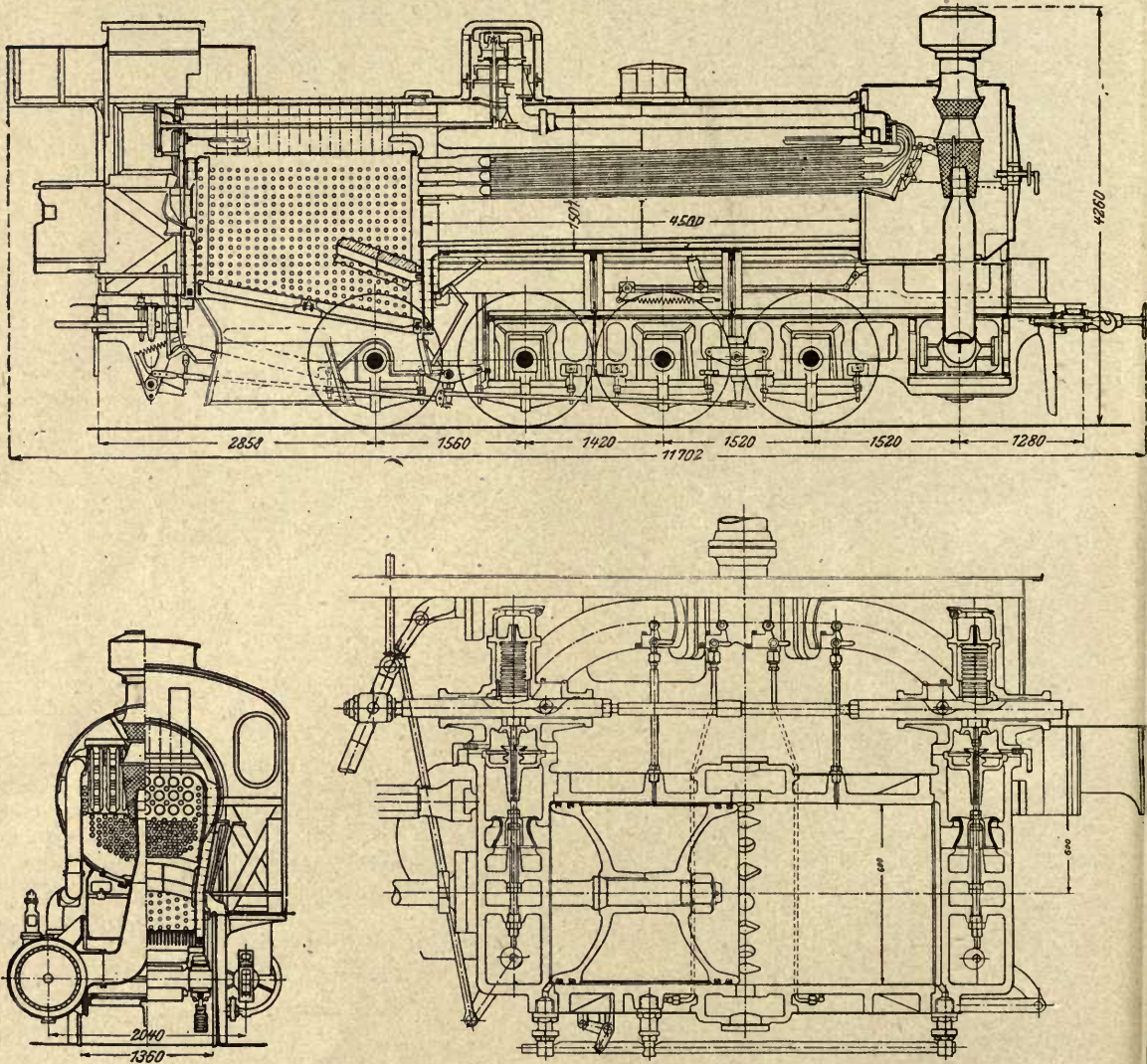


Fig. 3.

the piston or cause warping of the cylinder, and the central exhaust belt effectively cools the middle part of the latter where the piston attains its highest velocity.

For the non-condensing service of locomotives it was necessary to provide a large clearance volume, in this case of  $17\frac{1}{2}\%$ , for superheated steam of 12 at. gage. This large clearance is the weak point of the design, and in later engines

it was materially reduced. The greater part of the clearance space is disposed in the concave ends of the piston (Fig. 6). The piston heads thus take the shape of spherical caps, great strength and stiffness being thereby obtained. They are made of cast steel and are fitted with two piston rings each. A distance piece or drum, made of hard forged steel 7 mm in thickness, is placed between the heads and the whole is clamped together by means of the piston rod and nut, for which purpose a certain amount of clearance is left between the hubs of the piston heads. The supporting drum has a clearance of three thousandths of the diameter, so that for a cylinder bore of 1000 mm its diameter would be 997 mm. This would bring the piston center line  $1\frac{1}{2}$  mm below the cylinder center. The allowance takes care of the expansion and distortion of the cylinder and drum. Special consideration must be paid to the expansion of the heads, since they are exposed to the full live steam temperature during admission. They therefore expand more than the supporting drum and thus distend the ends of the latter, whereby scoring of the cylinder may be caused. This was a source of difficulty in some of the earlier pistons, but was overcome by using a sphere of smaller radius for the piston heads and providing a larger allowance for the ends of the supporting drum.

Lubrication is effected, not by introducing oil into the steam chest, but by feeding it to a number of points in the cylinder wall, and thus bringing it directly to the working surfaces. Each end of the cylinder has three oil feeds, one on top and one

on each side on the horizontal center line, each feed being supplied by an independent plunger. Even with this arrangement the oil may still carbonize and it is therefore better to place the feeds closer to the middle of the cylinder.

A tail rod with its attendant stuffing box was not used on these locomotives. A gain in weight thus results, but the long piston, the length of which is given by the stroke less the exhaust lead, generally works out heavier than the standard piston with tail rod.

The necessary clearance volume depends upon the pressure and temperature of the live steam. Assuming the back pressure to be 1,1 at. abs. (0,1 at. being added for the resistance in the blast pipe), 90% length of compression (adiabatic), quality

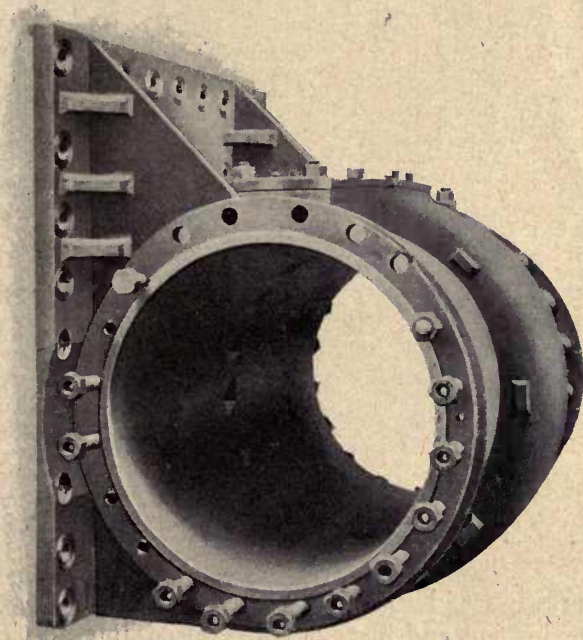


Fig. 4.

of steam = 1, and terminal compression pressure = live steam pressure, then for different steam pressures the following clearances are necessary:

Steam pressure, at. gage	11	12	13	14	15	16	17	18	19
Clearance volume . . %	16.9	15.8	14.6	13.9	13.1	12.6	12.1	11.6	11.1

In using this table it must be borne in mind that a pressure loss of about 1 at. occurs in the superheater, and that the clearance should be increased by such an amount that for normal cut-off the difference between the terminal com-

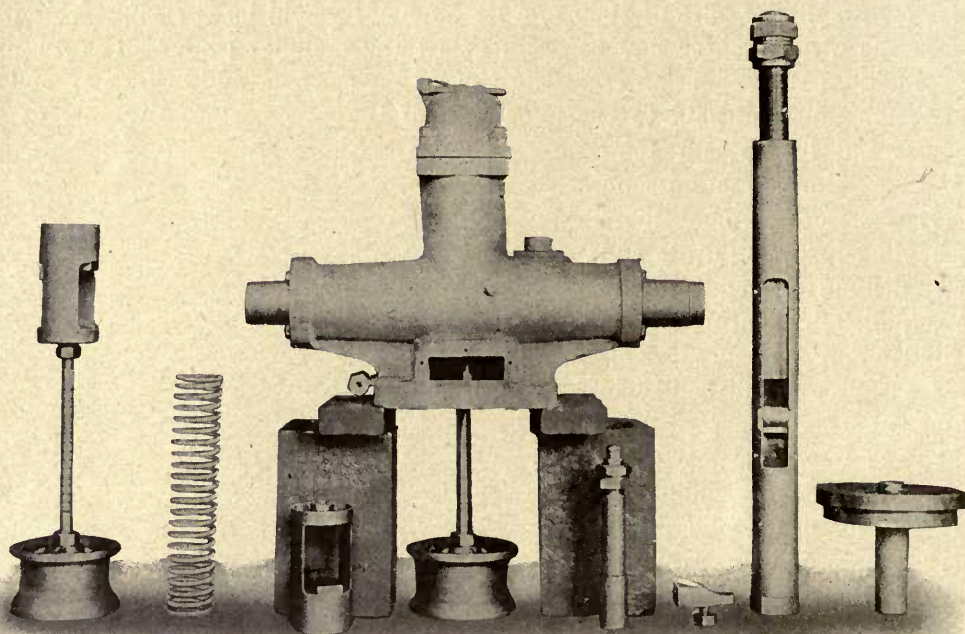


Fig. 5.

pression and live steam pressure is equal to the difference between the terminal expansion and back pressure, according to the rules given in the chapter on volume loss.

The una-flow action is not limited to the steam, but applies also to any foreign matter contained in it, such as scale, mud, cinders or soot. The latter are swept out by the exhaust steam through the central ports and escape through an orifice or drain at the lowest point. The una-flow action therefore permanently maintains the interior of the cylinder in a clean state.

The drain just mentioned also insures the removal of water, and thus eliminates a difficulty occurring in all ordinary locomotives. The cylinder in the latter forms the lowest point of the system, the live steam enters from the top, and the exhaust steam leaves the cylinder also at the top. Damage due to water, such as fractured cylinders and covers, as well as breakage of driving parts, are possible with this arrangement. Nothing of this kind can happen with a una-flow locomotive, since the water is effectively cleared from the cylinder by the exhaust steam

and passes away through the drain. It is surprising to see how much water is ejected through this drain when starting with a cold cylinder. A different kind of water hammer may be caused by the kinetic energy of water, apart from its being trapped in the cylinder, and this may of course happen in a una-flow engine.

Fig. 3 also shows a mechanism by means of which both valves may be lifted off their seats from the cab, thus putting the two sides of the piston in communication with each other through the inlet pipe, and relieving the compression when coasting. It is advisable to provide considerable lift for the

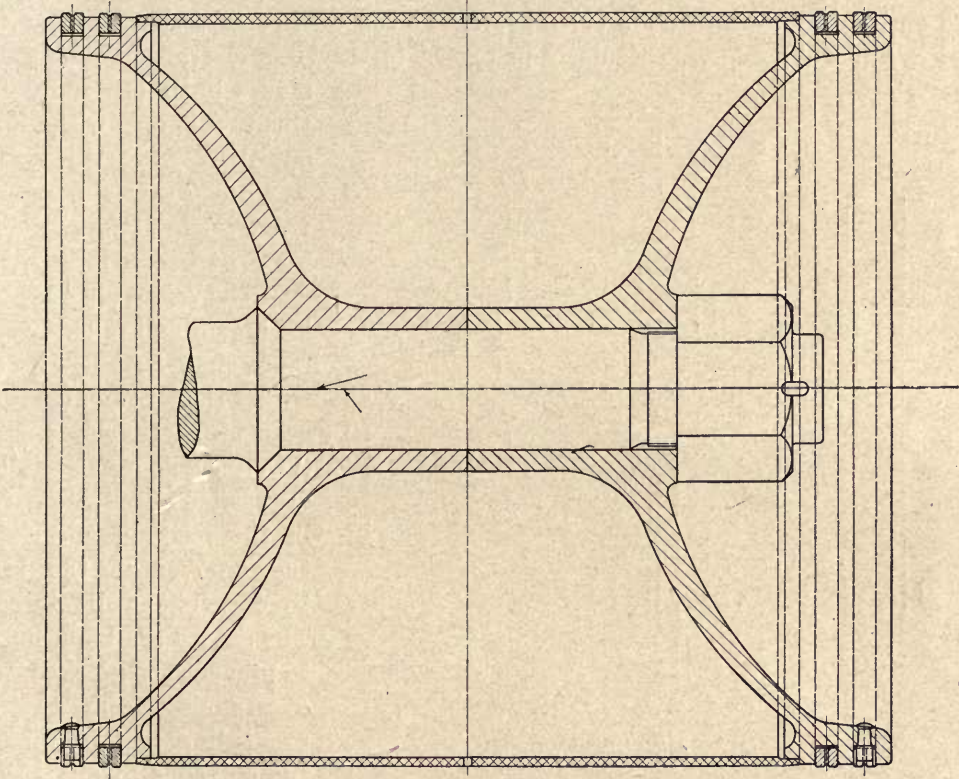


Fig. 6.

valves, as otherwise when running down a long grade the temperature of the steam pulsating to and fro between the cylinder ends will become so high in consequence of friction and wiredrawing that the oil may carbonize and cause piston troubles. The admission of cool air to the cylinder through a valve opened simultaneously with the lifting of the steam valves is also recommended. When the steam valves are lifted together with their cams, the rollers should run clear of the latter so as to prevent unnecessary wear. In contrast to the special by-pass arrangements used in ordinary piston valve cylinders, the valve gear of the una-flow locomotive, with only minor additions, provides a by-pass for coasting without increasing the clearance volume and harmful surfaces.

The exhaust lead is usually taken at 10%, thus fixing the length of compression at 90%. A rapid uncovering of too large a port area may produce an

abrupt exhaust and a pulsating draft in the fire box, whereas a uniform draft is desirable for good combustion. This may be realized by using a large exhaust lead in combination with a correspondingly small area of ports and of the blast pipe, as well as by interposing some form of receiver or exhaust chamber, thus allowing of better expansion of the exhaust and serving to muffle the noise.

In ordinary locomotives the steam distribution for very early cut-offs is unsatisfactory, and for this reason throttling of the steam is usually employed instead of making the cut-off earlier. In contrast to this, the una-flow locomotive can be run entirely without throttling, and allows the power requirements to be regulated entirely by means of the valve gear. The constant compression on the other hand is a disadvantage, particularly in regard to the large clearance volume, and makes itself especially felt when running with large cut-offs.

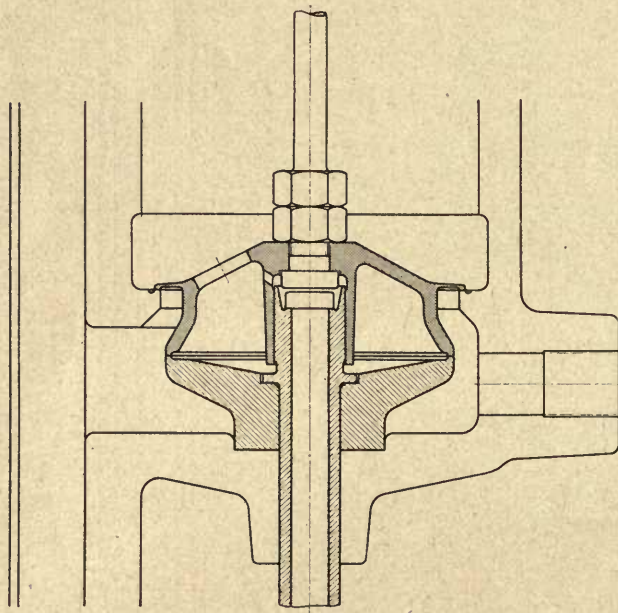


Fig. 7.

Fig. 7 shows a resilient valve made of forged steel, for a passenger locomotive.

The valves are operated by a cam and roller mechanism similar to that used with the Stumpf valve gear for stationary engines (Fig. 8). The cam rollers are carried in milled grooves in the reciprocating slides, the grooves at the same time serving as oil retainers. The guides are long enough to prevent the grooves from overrunning them, thereby preventing loss of oil and the entrance of dust. The

oil lubricating the cam crosshead or guide collects mostly in these grooves, and is transferred by the rollers to the cams so that proper lubrication of these important parts is insured. The guides themselves are provided with wick oilers. The roller slides are operated by a standard Walschaert gear without any changes from that used on existing counterflow locomotives. Both roller slides have screw adjustments.

The valve spring is arranged to be adjustable and must be powerful enough to allow of running with late cut-offs at high speeds.

Fig. 9 shows a double-seated automatic compression release valve which is in communication with both ends of the cylinder through two pipe connections. The entrance to each pipe is controlled by a valve which may be operated from the cab. When these valves are opened the live steam from one cylinder end closes the corresponding side of the compression release valve and opens the other, so that the compression steam of the opposite cylinder end may escape through the

passage between the two seats of the auxiliary valve. When admission occurs at the opposite end of the cylinder, the auxiliary valve changes its position, so that compression is now relieved on the other side. The passage between the

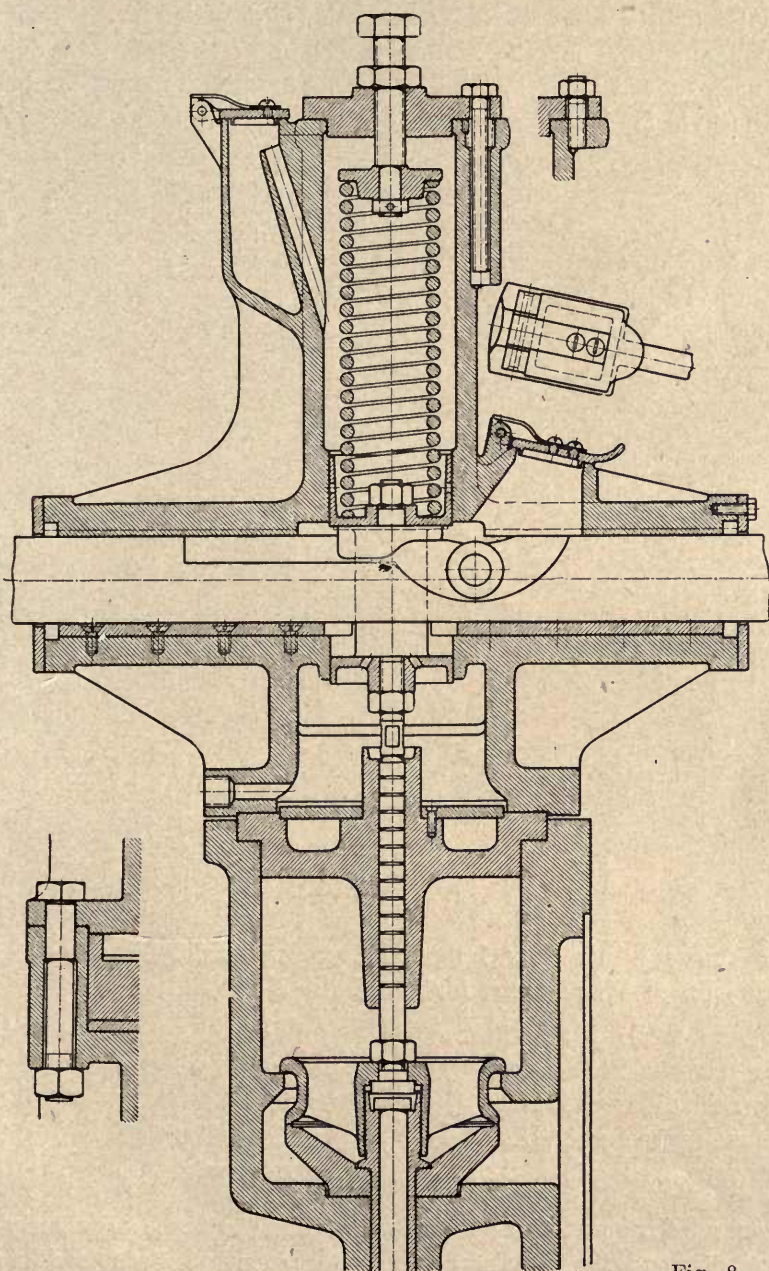


Fig. 8.

seats of the valve may be connected with the exhaust belt. This device therefore allows compression to be entirely eliminated, so that a great reserve of power becomes available for the difficult starting period. The shut-off valves at the cylin-

ders are closed as soon as the train is in motion, and the release valve thus becomes inoperative. Experience has shown, however, that the device is not absolutely essential.

Fig. 10 illustrates a una-flow freight locomotive exhibited at the Brussels International Exposition of 1910, cross-sections of which are shown in Fig. 3. In order to compensate for the increased weight of the una-flow cylinders, the boiler has been moved back on the frame by a small amount for better distribution of the axle loads.

Cylinder bore . . . . .	600 mm	Superheater surface . . . . .	38.97 sqm
Stroke . . . . .	660 „	Grate area . . . . .	2.35 „
Driving wheel dia. . . . .	1350 „	Weight, empty . . . . .	52125 kg
Steam pressure, gauge . . . . .	12 at.	Service weight . . . . .	57750 „
Boiler heating surface . . . . .	140.42 sqm		

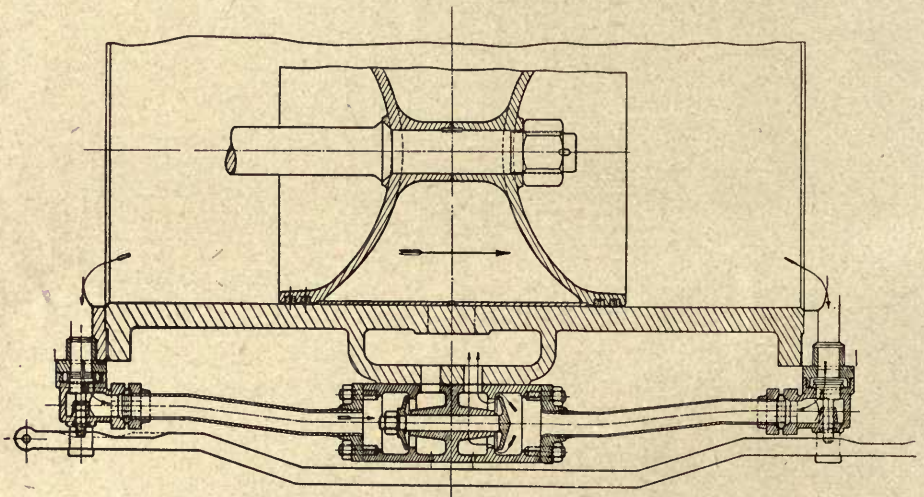


Fig. 9.

Fig. 11 shows a una-flow freight locomotive built by the Schweizerische Lokomotivfabrik, of Winterthur, for the Swiss Federal Railways.

Cylinder bore . . . . .	570 mm	Boiler heating surface . . . . .	143.7 sqm
Stroke . . . . .	640 „	Superheater surface . . . . .	37.6 „
Driving wheel dia. . . . .	1330 „	Grate area . . . . .	2.44 „
Leading truck wheel dia. . . . .	850 „	Weight, empty . . . . .	60875 kg
Steam pressure, gauge . . . . .	12 at.	Service weight . . . . .	67700 „

The general design of the cylinders is similar to those previously described, with the exception that a muffler has been incorporated in the saddle supporting the smoke box, between the exhaust belt and the blast pipe (Fig. 12).

Fig. 14 shows a una-flow passenger locomotive built by the Maschinenbauanstalt Breslau for the German State Railways. An engine of this type was exhibited at the Turin Exposition.



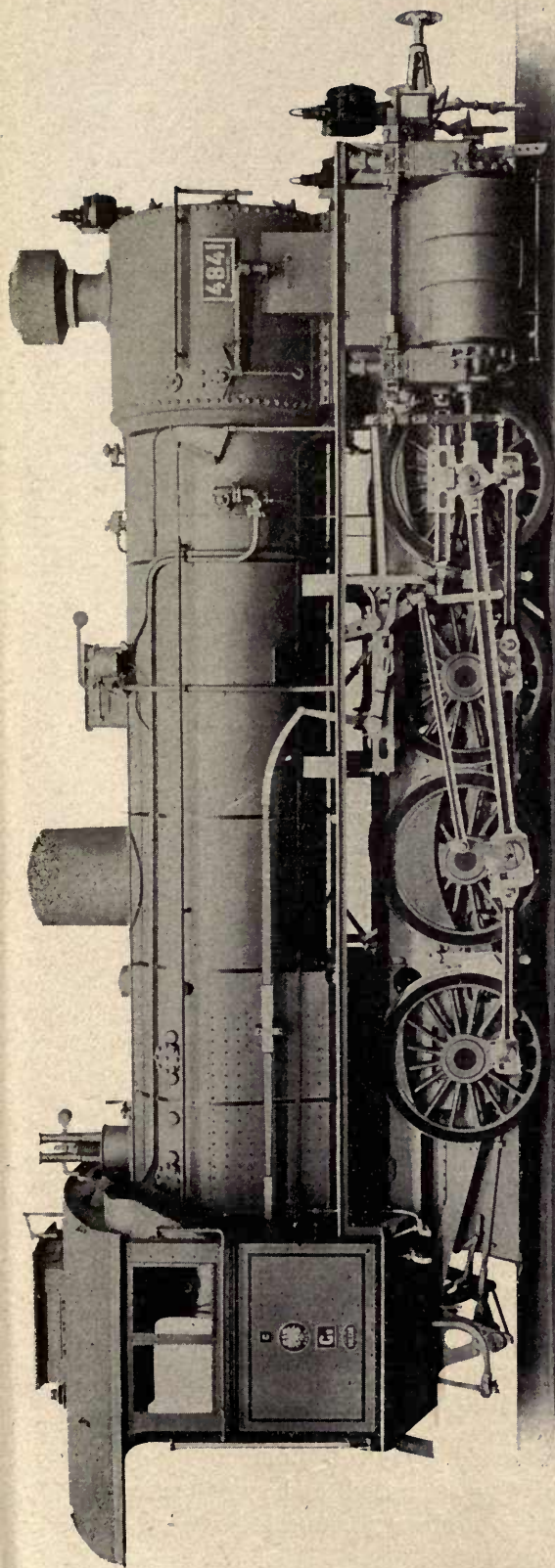


Fig. 10.

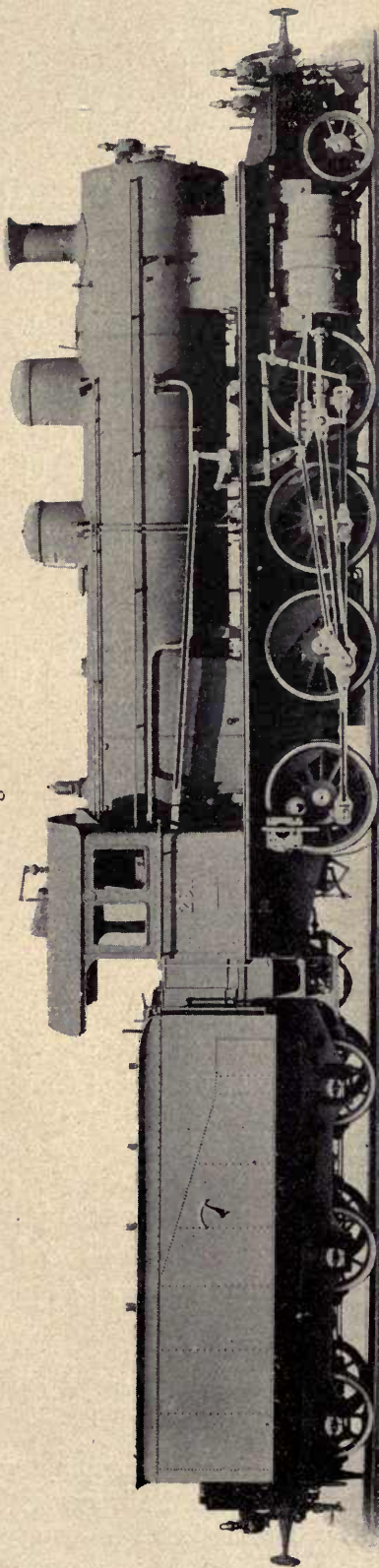


Fig. 11.

Cylinder bore . . . . .	550 mm	Driving wheel dia. . . . .	2100 mm
Stroke . . . . .	630 ,,	Truck wheel dia. . . . .	1000 ,,
Steam pressure, gauge . . . . .	12 at.	Grate area . . . . .	2.31 sqm
Boiler heating surface . . . . .	136.98 sqm	Weight, empty . . . . .	56900 kg
Superheater surface . . . . .	40.32 ,,	Service weight . . . . .	62500 ,,
Total heating surface . . . . .	177.30 ,,	Adhesive weight . . . . .	35000 ,,

The Northern Railway of France had a superheater freight locomotive fitted with una-flow cylinders which were designed by the author in a similar way to those previously described, the existing Stephenson link valve motion being retained.

In Fig. 14 is shown a una-flow passenger locomotive for saturated steam, two of which were built by the Kolomna Engine Works for the Russian State Railways. Two other engines of the same design were fitted with superheaters. The former run with 14, and the latter with 12 at. gage pressure. The extra pressure

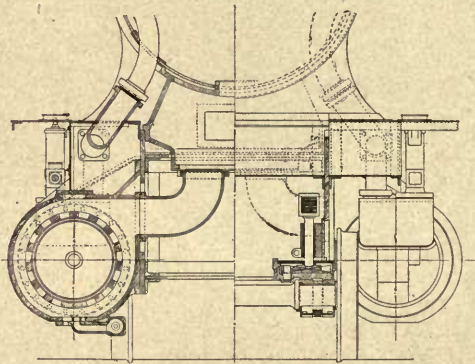


Fig. 12.

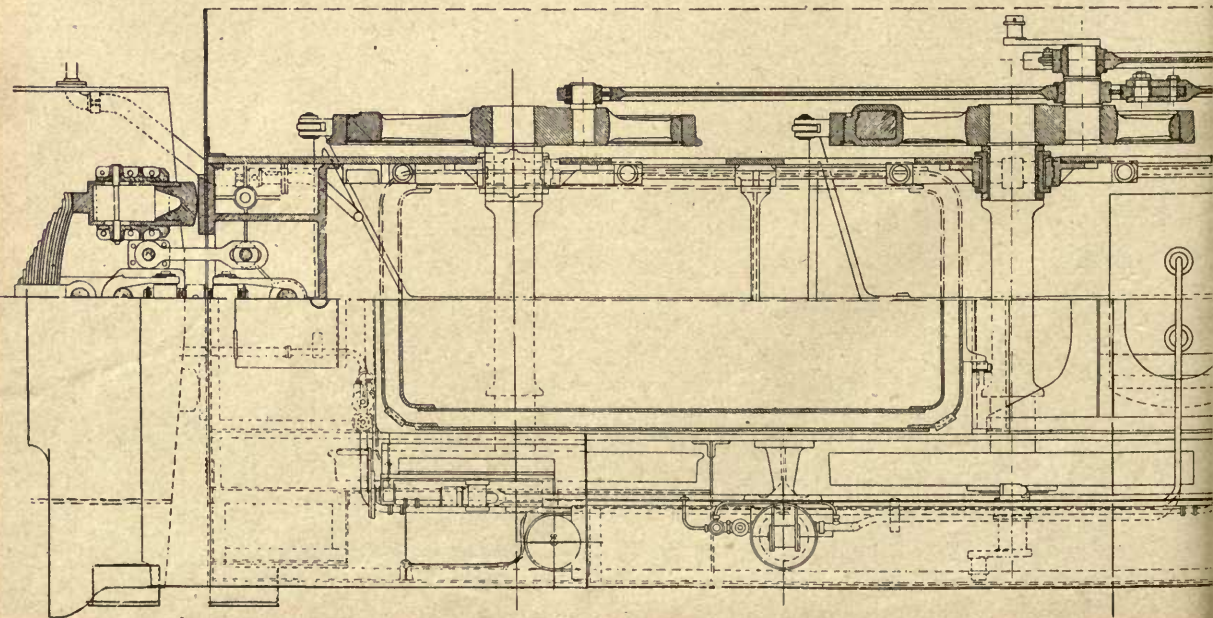
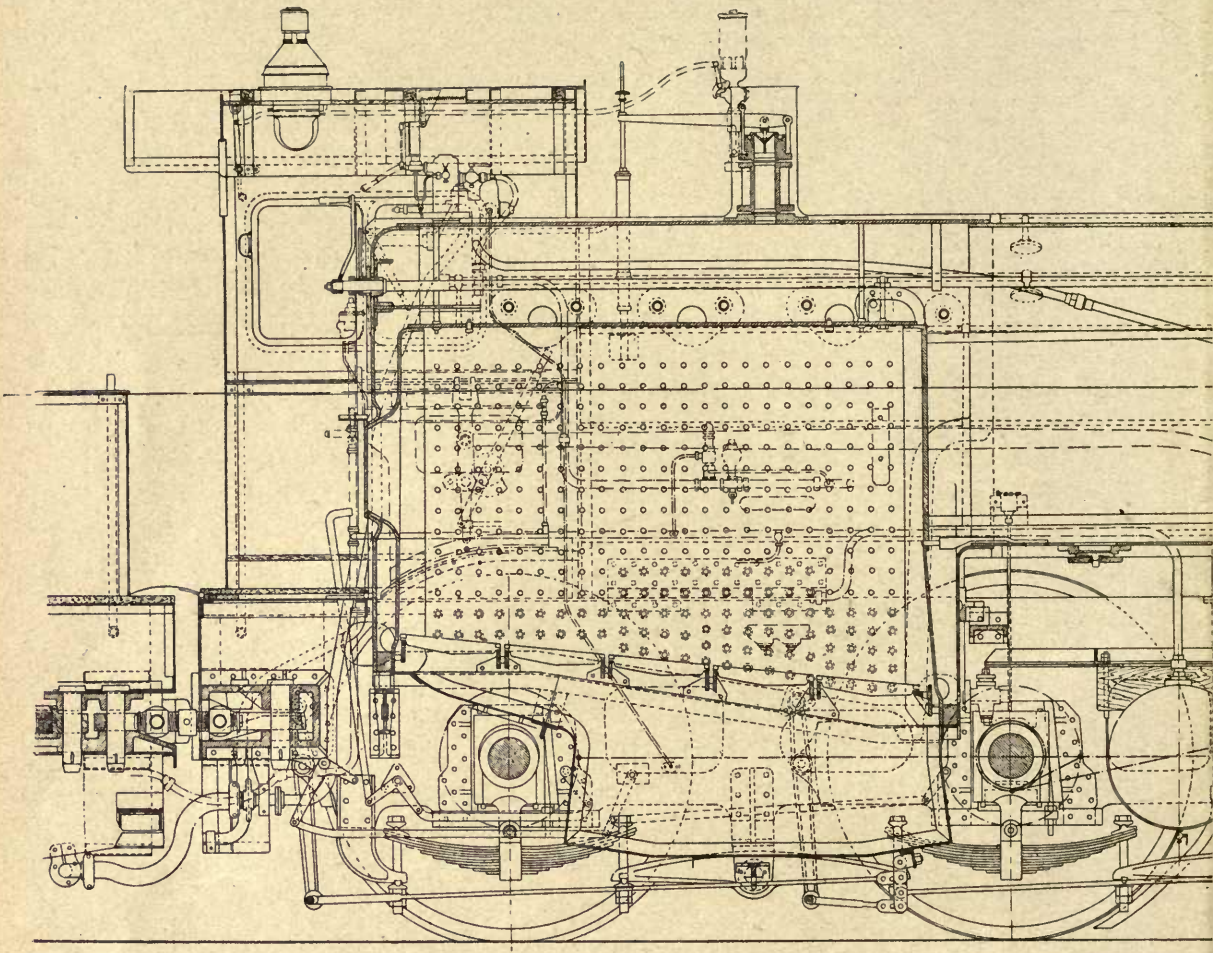
carried by the engines using saturated steam was rendered possible for the same axle loads by putting the weight of the superheater into the heavier boiler plates. Since there is a loss of about 1 at. in the superheater, there is a gain of 3 at. in favor of the locomotive using saturated steam. All previous experiences and test results were utilized in the design of the cylinders. Attention is directed especially to the careful jacketing of the heads and ends of the cylinders for saturated steam. The condensate from the jackets is returned to the boiler by a small pump with suction ports, operated by a cam on the roller rod.

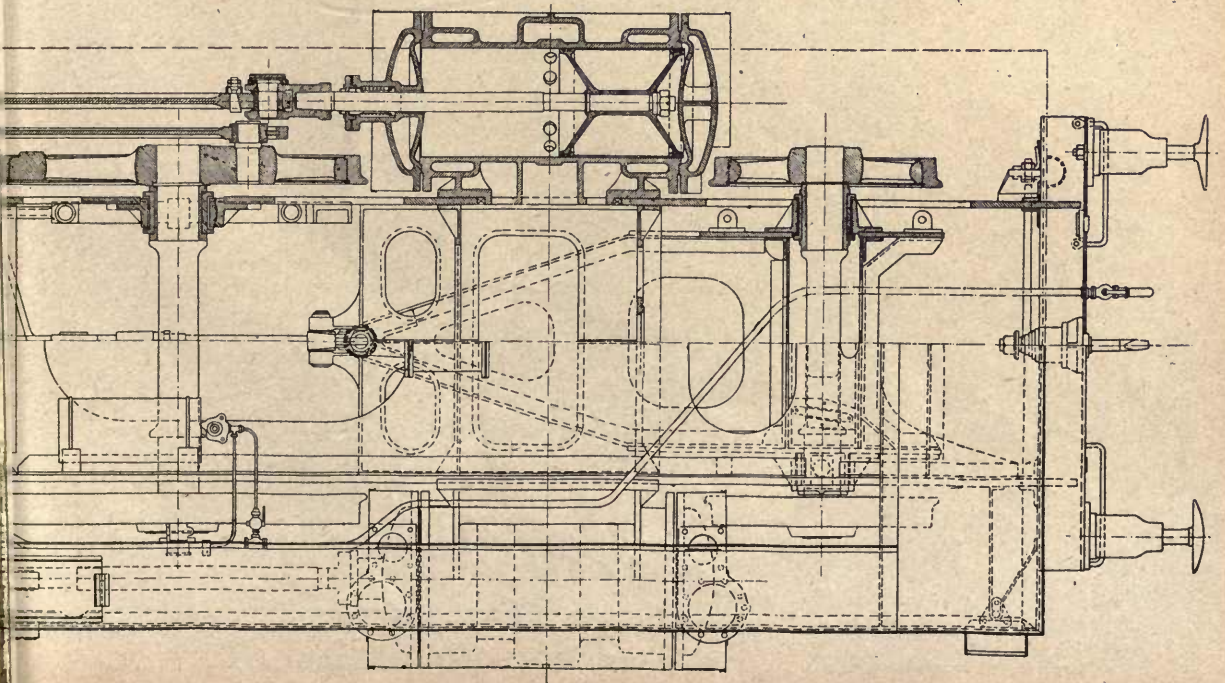
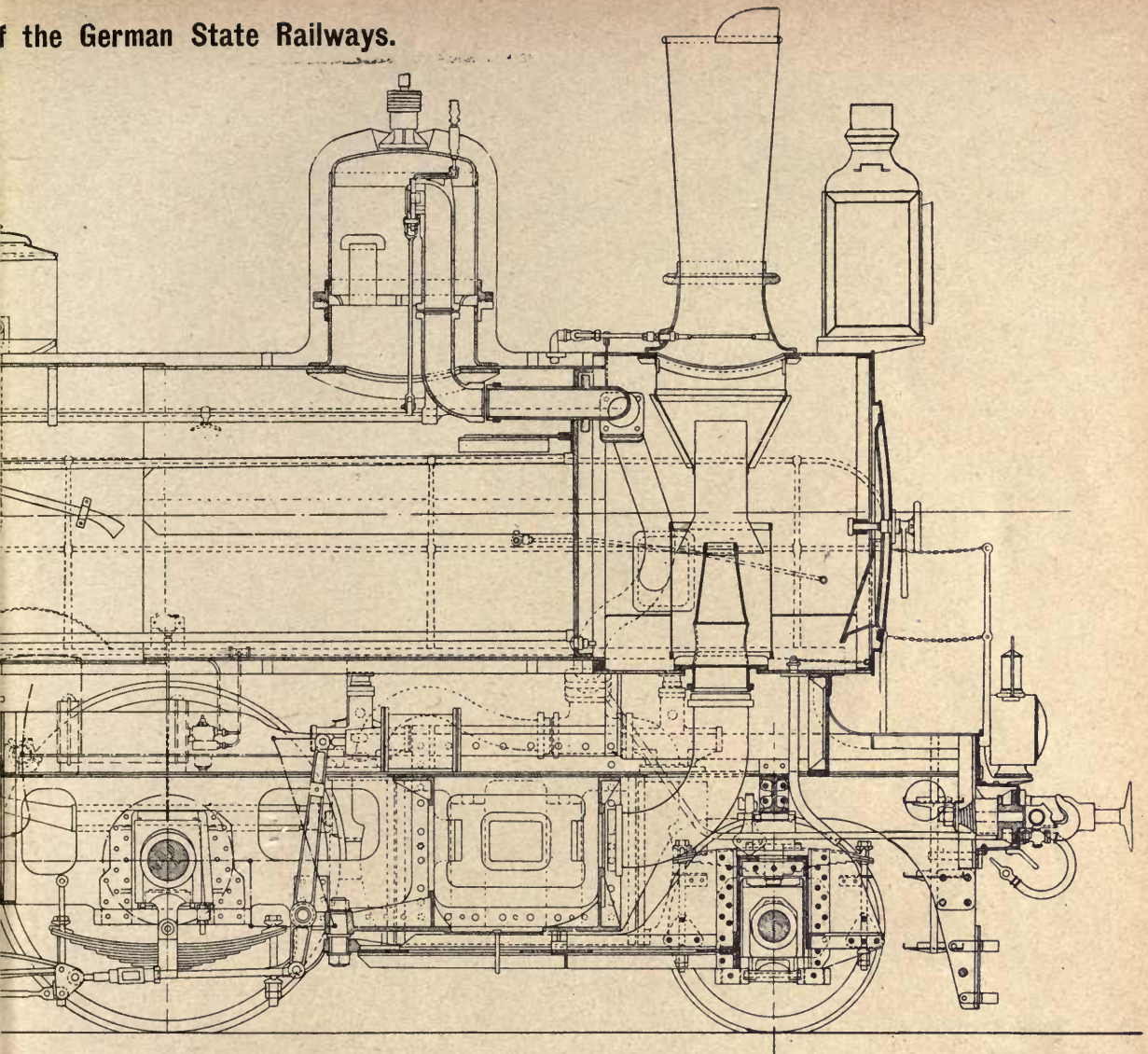
Main dimensions of the engines using saturated steam:

Cylinder bore . . . . .	500 mm	Stroke . . . . .	650 mm
Driving wheel dia. . . . .	1700 ,,	Heating surface . . . . .	166.57 sqm
Steam pressure, gauge . . . . .	14 at.	Grate area . . . . .	2.45 ,,

A series of comparative tests were made by Prof. Lomonosoff on the Russian State Railways on one each of the saturated and superheater una-flow locomotives, in competition with two ordinary saturated steam com-









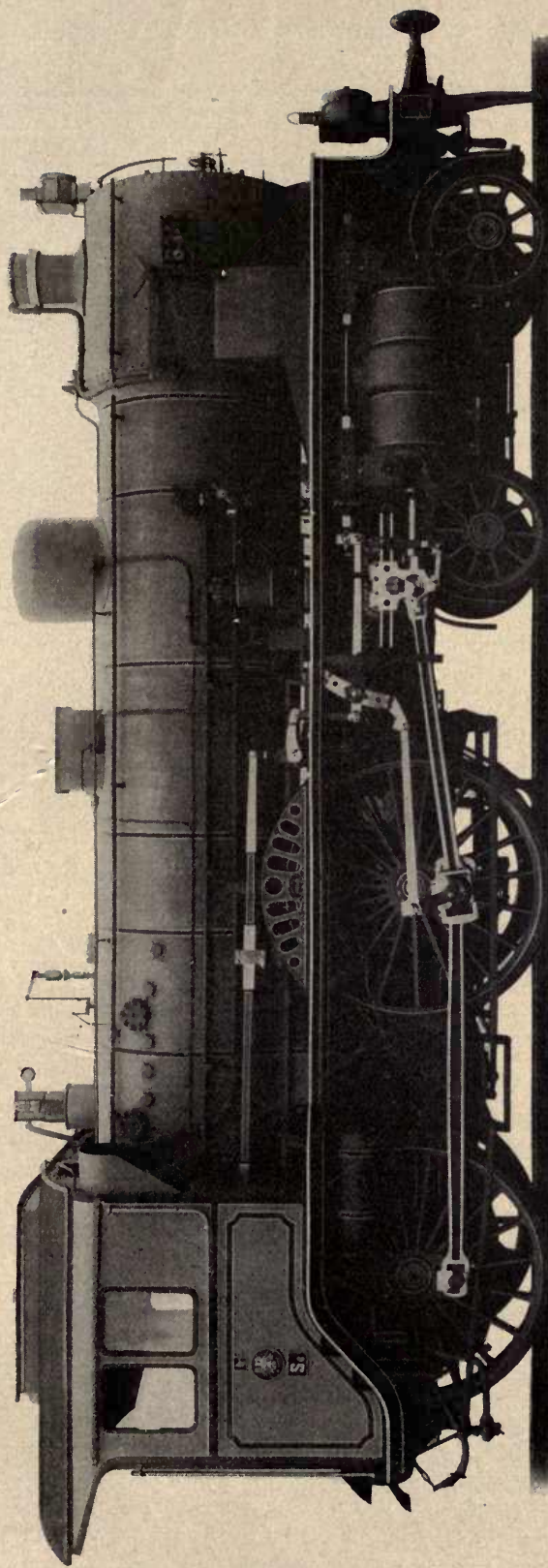


Fig. 14.

pounds and one superheater compound locomotive. The results of these tests are as follows:

2-6-0 two cylinder locomotive, Driving wheel dia. 1700 mm Three-axle tender		Saturated Steam			Superheated Steam	
		Compound		Una-flow	Una-flow	Compound
Train weight 350 tons Tver to Moscow	V	51.5	50.3	50.5	54.3	49.6
	G	35.6	37.7	35.7	30.8	29.2
	Z	42.8	36.9	41.5	45.8	37.4
Train weight 270 tons Moscow to Tver	V	67.3	71.0	73.3	76.3	69.0
	G	43.9	38.8	32.7	29.4	32.0
	Z	41.1	42.1	41.3	42.5	38.1
Train weight 424 tons Moscow to Tula	V	49.4	51.6	43.3	47.9	44.6
	G	28.3	31.8	35.3	25.0	23.7
	Z	39.8	42.9	49.5	42.5	34.7
Train weight 270 tons Tula to Moscow	V	56.8	56.8	55.4	59.9	57.9
	G	40.1	38.5	36.4	28.0	30.1
	Z	40.5	36.0	34.5	37.5	33.7

V = Mean speed in km/hour.

G = Naphta consumption per 1 ton-km.

Z = Evaporation per 1 sqm of boiler heating surface.

These figures permit of a fair comparison of the economy of the locomotives; since for one run the total number of ton-km is the same for all locomotives, their output must also be practically equal, except for changes in the train resistance caused by wind and other weather conditions. The evaporation Z per 1 sqm, however, is different for every locomotive and no conclusion can therefore be drawn from the same.

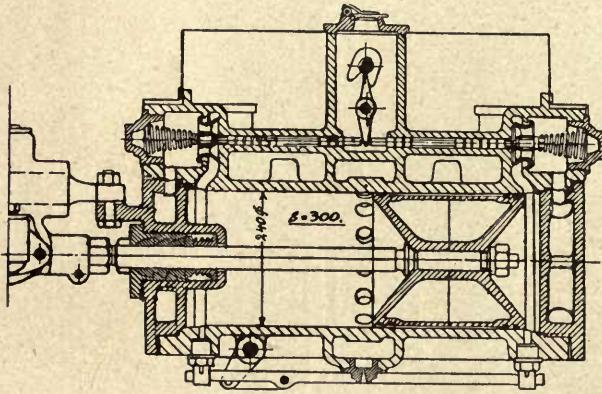


Fig. 15.

The line from Moscow to Tver is almost level, but that from Moscow to Tula has long and heavy grades in both directions.

The conclusions which can be drawn from these tests are as follows:

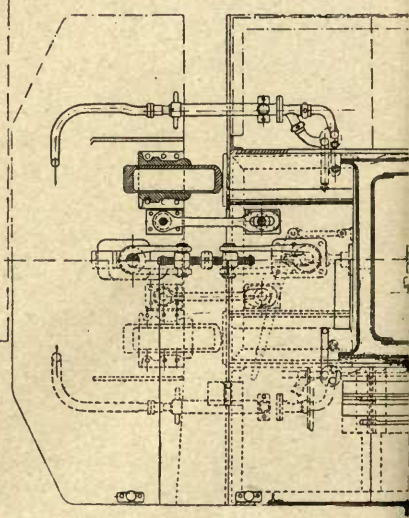
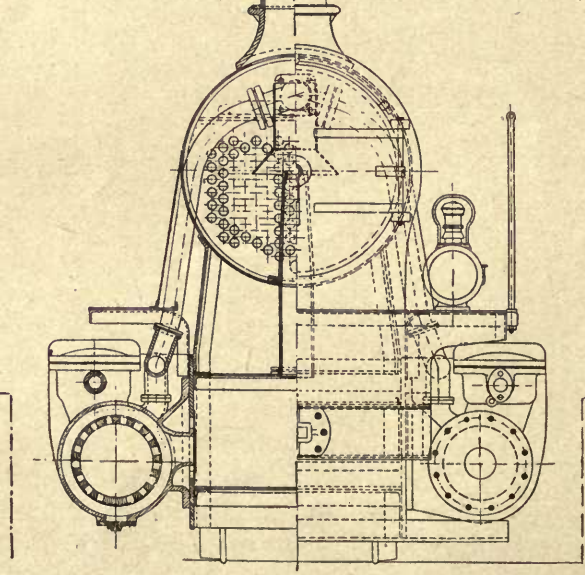
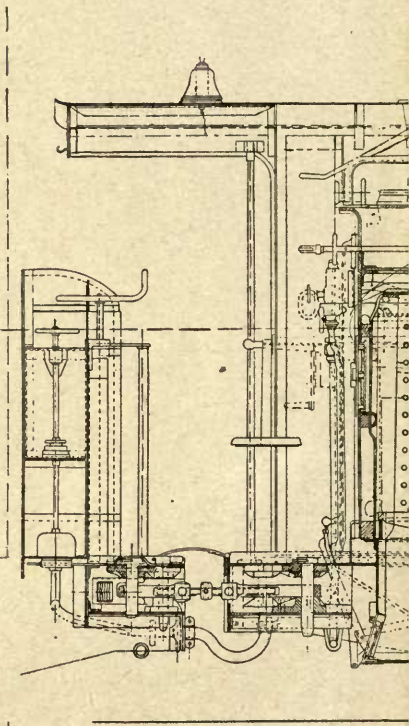
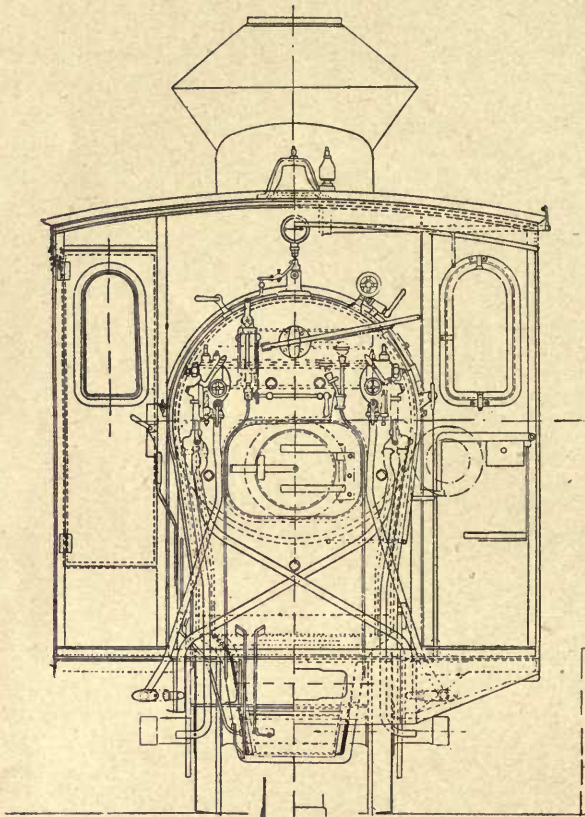
The una-flow locomotive shows better economy than the compound for small loads, while at higher loads its fuel consumption is higher than that of the latter. This can be easily explained by the effect of the long constant compression and the large clearance volume (see chapter on volume loss).

The una-flow locomotive working with saturated steam shows in general a higher economy than the compound except for long cut-offs. Larger cylinders would be of advantage in this case.

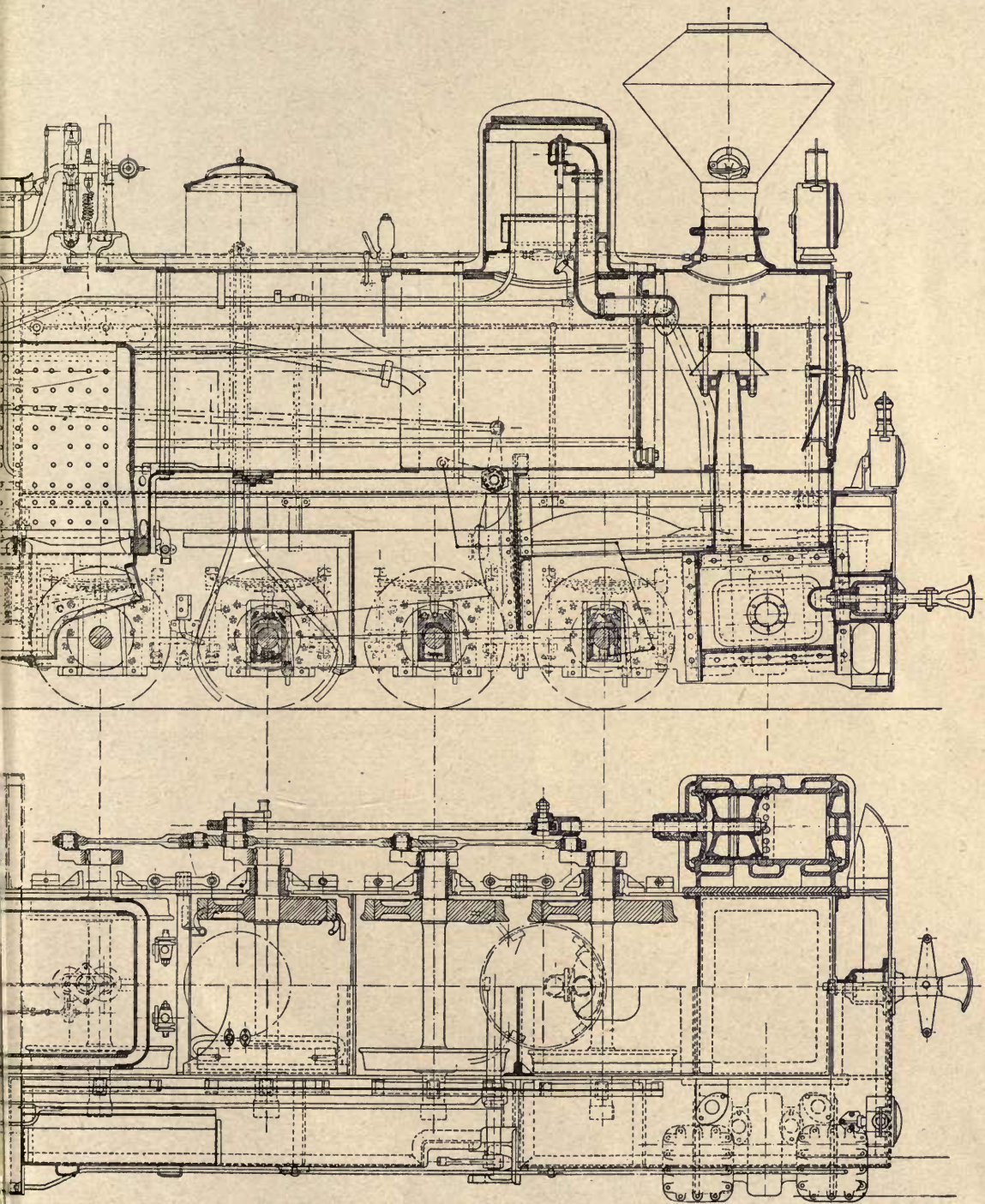




0-8-0 Una-Flow Locomotive



the Moscow Narrow Gage Railway.





The superheater una-flow locomotive is at least on a par with the superheater compound, although even here the former has a slightly higher fuel consumption for heavy loads. Larger cylinders are of course more feasible with the una-flow system than with the compound engine.

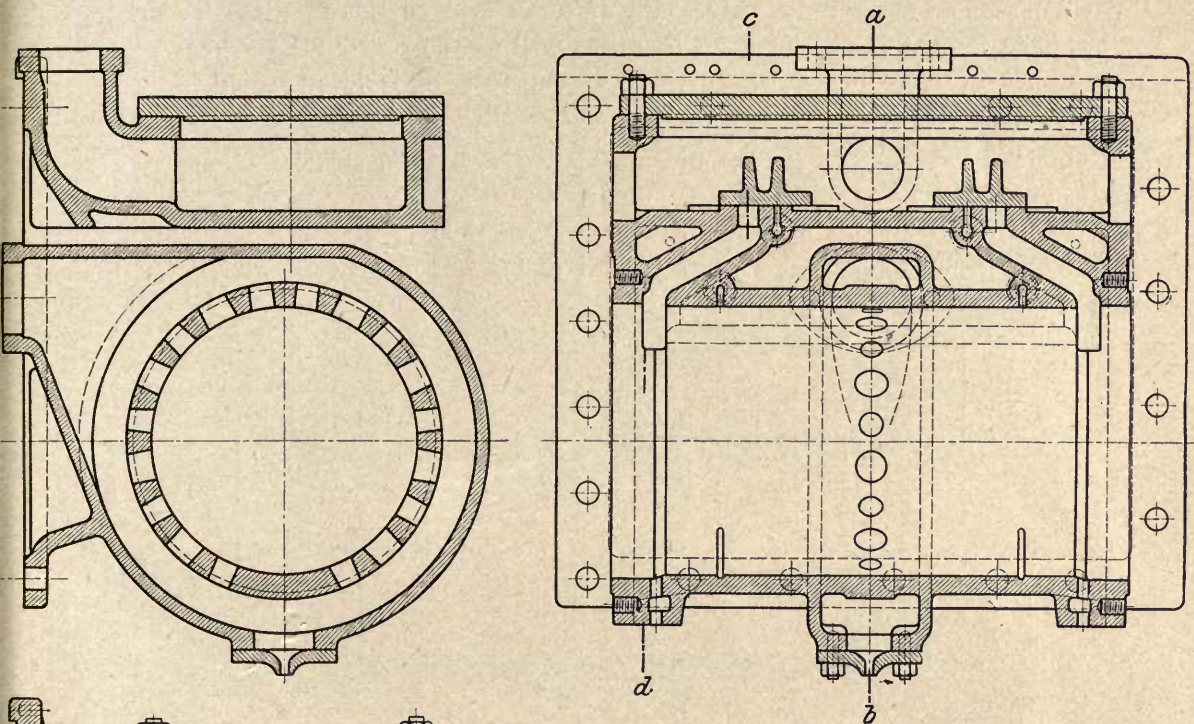


Fig. 17.

Fig. 15 shows a una-flow cylinder with horizontal valves for a small locomotive built by the Kolomna Engine Works. The mechanism operating these valves is of interest; it consists of a double armed lever, the lower end of which works against the valve stems while its upper end receives its motion from a rocking lever fitted with two cam profiles which are alternately in rolling contact with it. The rocking lever is driven by a Marshall gear. Attention is drawn to the accessibility of the valves which are removable after taking off the valve chest covers, without disturbing any other part of the gear.

It will be noted that the Kolomna Engine Works consistently adhere in all their designs to the true una-flow arrangement. Much value is placed by these builders on the series arrangement of live steam space, inlet valve, piston and exhaust.

In Fig. 17 are given the main sections of a una-flow cylinder for a narrow gage locomotive (Fig. 16) using saturated steam, built by the Kolomna Engine Works, which was shown at the Turin Exposition. In view of the small size of the cylinders, the latter are fitted with slide valves, which are separate for each cylinder end. Since these valves are of small area compared with that of the ordinary *D*-valve, the load upon them, as well as the resistance which the valve gear has to overcome, is considerably diminished. Reliable operation is insured by feeding oil under pressure to their working faces.

Cylinder bore . . . . .	355 mm	Boiler heating surface . . . . .	54.26 sqm
Stroke . . . . .	350 „	Grate area . . . . .	0.93 „
Driving wheel dia. . . . .	750 „	Weight empty . . . . .	19.2 tons
Steam pressure . . . . .	12 at. gage	Service weight . . . . .	21.2 „

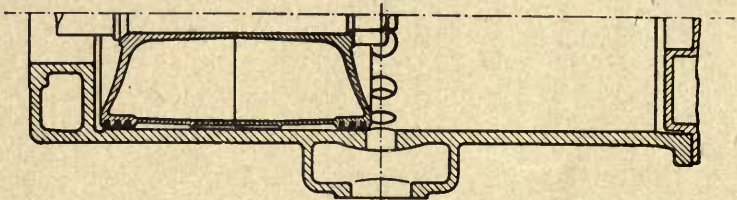


Fig. 18.

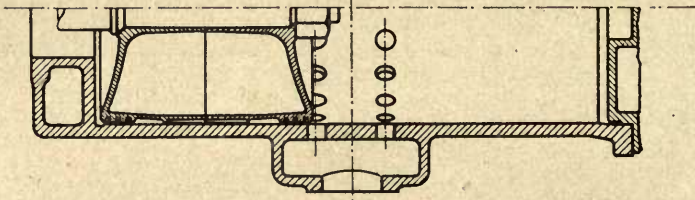


Fig. 19.

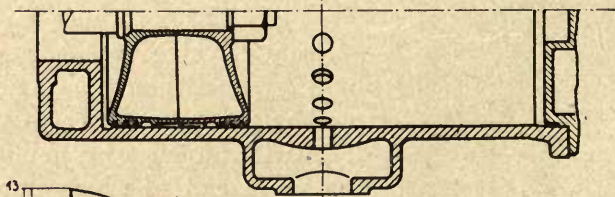
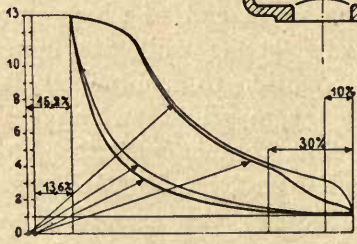


Fig. 20.



It is the policy of the Kolomna Engine Works, in cases where superheating is not acceptable, to obtain improved economy by applying the una-flow system. In this way they rebuilt with una-flow cylinders eleven saturated steam locomotives of the tank type of the Warsaw narrow gage railway during the years 1913—1914. These una-flow cylinders are fitted with piston valves and have the cylinder ends jacketed, in addition to the heads.

The use of two rows of central exhaust ports with a simultaneous increase of the exhaust lead from 10 to 30% considerably shortens the cylinder and piston, as shown in Fig. 18. The second set of exhaust ports provides a very effective increase in port area shortly before dead center. If this advantage is not considered essential, then the use of a single row of ports with the same exhaust lead of 30% will still further reduce the length of the cylinder and piston (Fig. 19).

It is important to reduce the port area as the exhaust lead is lengthened in order to keep the loss of diagram area at the end of the stroke within reasonable limits. (See diagram Fig. 20.) The long exhaust lead at the same time shortens

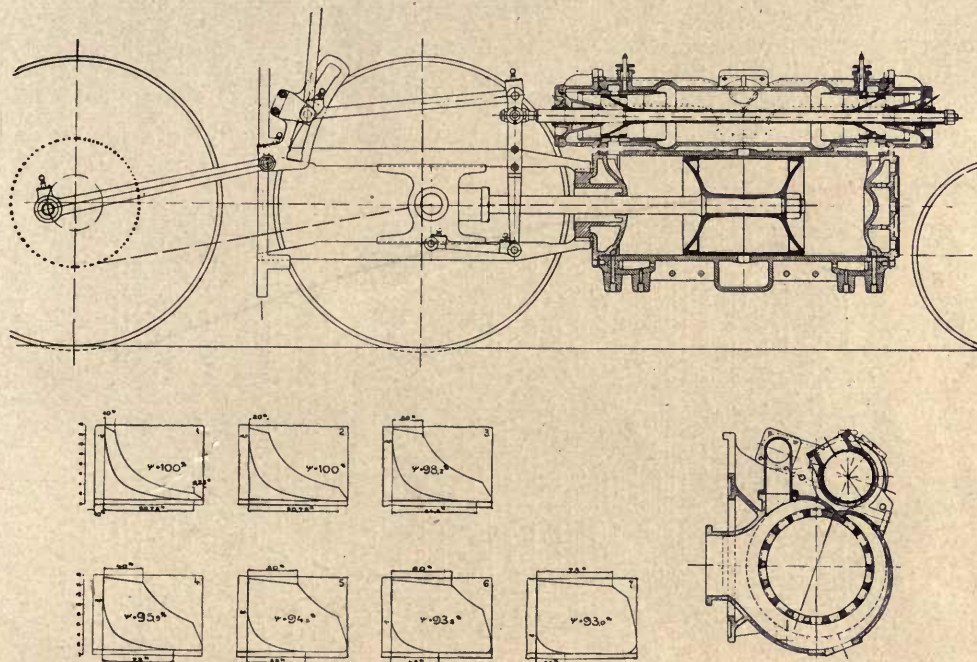


Fig. 21.

the compression from 90% to 70% and reduces the clearance volume from 16,2% to 13,6%. This reduction of the length of the cylinder and the saving in weight of both cylinder and piston should prove of value particularly for locomotives.

The design of the una-flow locomotive cylinder shown in Fig. 21 differs from those previously described in that the piston valve gives a supplementary exhaust for long cut-offs and the engine operates on the true una-flow cycle only for early cut-offs. As is shown by the indicator diagrams, the true una-flow cycle is maintained for cut-offs up to 30%. For longer cut-offs an auxiliary (counter-flow) exhaust comes into effect, which shortens the compression with increasing cut-off. In this way starting is facilitated for long cut-offs, and the advantage of the full una-flow cycle for steady running is yet retained. The compression release device shown in Fig. 9 is thus dispensed with in this case. The varying length of the compression considerably reduces the volume loss at late cut-offs, but this is obtained at the expense of the series arrangement of live steam, inlet valve, piston and

exhaust. The piston valve has inside steam admission, and the outside lap controls the supplementary exhaust. The inlet and exhaust at each end of the piston valve are in parallel with the piston, and steam leaking by the valve will pass directly into the exhaust. The supplementary exhaust is conducted from the ends of the piston valve housing to the exhaust belt through separate pipe connections. The piston is built up of two cast steel pieces, each of which is fitted with a bronze shoe. Fig. 22 shows a similar piston valve design which was used for two passenger locomotives of the German State Railways. A corresponding design was employed for the cylinders of a una-flow locomotive of the North Eastern Railway of England (Fig. 23), and for those of the locomotives of the Neuruppin-Kremmen-Wittstock Railway (Fig. 24).

This same cylinder and piston valve design was also used for the three cylinder passenger superheater locomotives (Fig. 25) built for the German State Railways by the Vulkan Engine Works of Stettin. The three cranks are set at  $120^{\circ}$ .

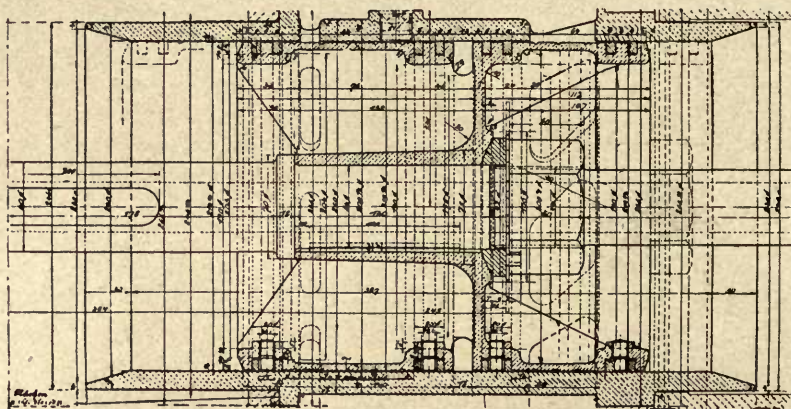


Fig. 22.

The two outside cylinders drive the second coupled axle, and the inside cylinder, which is placed slightly ahead of the others, operates the first driving axle. By distributing the piston loads upon two axles a longer life of the center crank axle is expected, especially since the forging can be made with easy curves, without disturbing the natural fibers of the material. The motion of the valve of the inside cylinder is derived from the two outside Walschaert gears, the movement of which is combined according to the parallelogram of velocities. The head ends as well as the crank ends of the three cylinders may be connected by means of special valves in order to relieve compression when coasting.

An examination of the exhaust timing of a three cylinder locomotive shows that the exhaust periods of the individual cylinders overlap; a very uniform draft in the fire box is thus obtained, particularly if an auxiliary exhaust is provided for long cut-offs. The three cylinders constitute an excellent reinforcement of the locomotive frame. The clearance volume of each cylinder is 11%, the bore 500 mm and the stroke 630 mm.



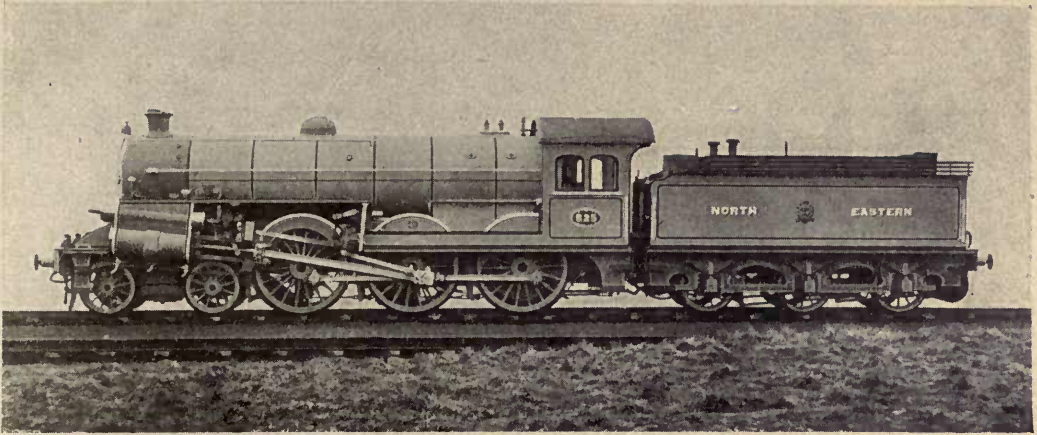


Fig. 23.

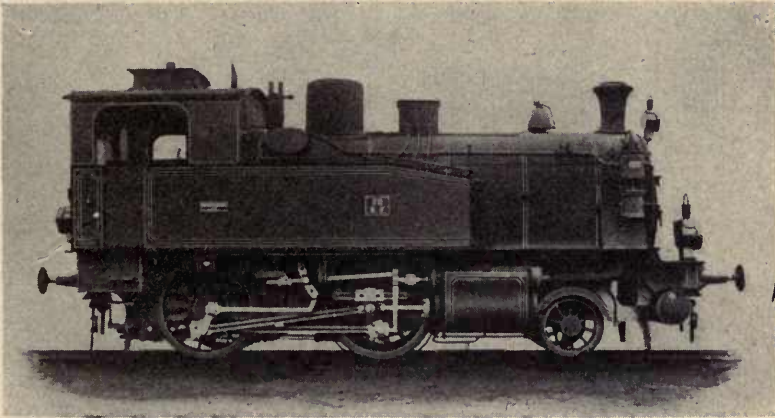


Fig. 24.

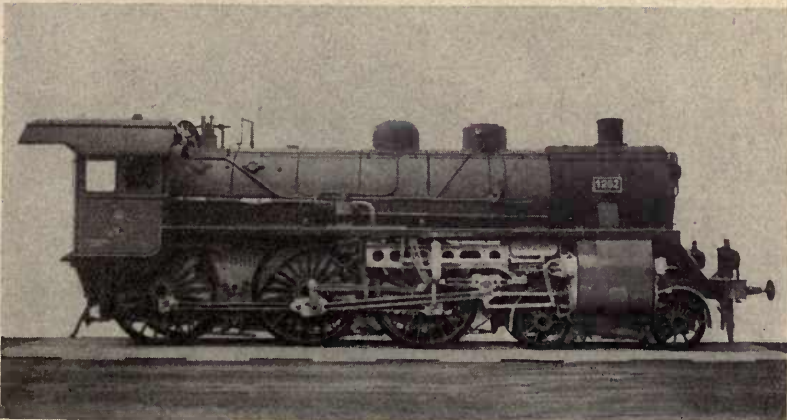


Fig. 25.

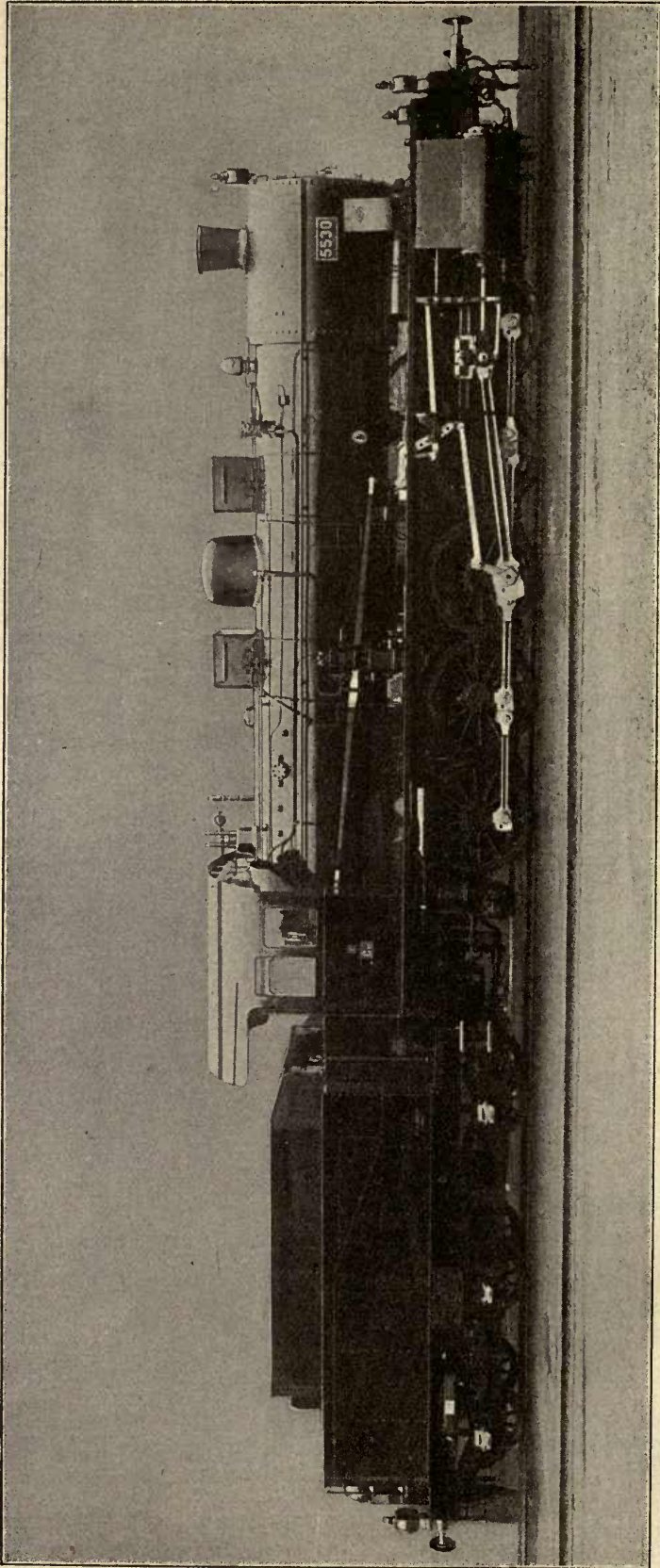


Fig. 26.



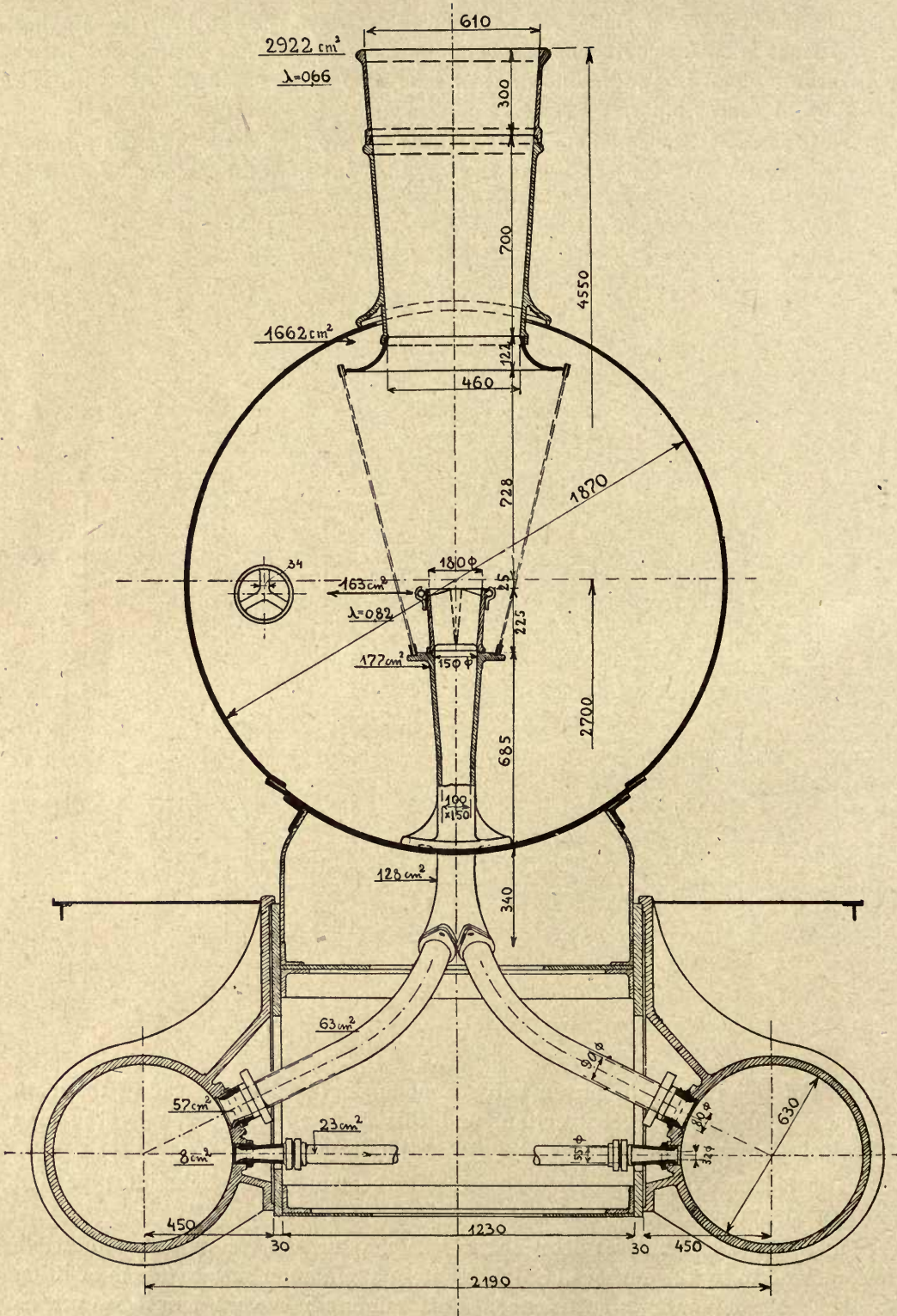


Fig. 28.

surface loss can also be realized in the counterflow construction if the whole cycle takes place in the superheated region, as is nearly always the case in modern superheater locomotives. A simultaneous reduction of the surface and volume losses to a minimum is possible with una-flow locomotives in the following manner.

A reduction of the volume loss while retaining the full una-flow cycle is possible by raising the initial, or lowering the back pressure. The latter way avoids the difficulties arising from a considerable increase in the boiler pressure and is based on the utilization of the large amount of energy still contained in the toe of the diagram, for the purpose of reducing the back pressure. This principle was described in chapter I, 7. Its first application is found on a superheater freight locomotive of the German State Railways, built in 1920 by A. Borsig of Berlin, according to designs furnished by the author. The main dimensions of the locomotive, which is illustrated in Figs. 26 to 28, are as follows:

Cylinder bore . . . . .	630 mm	Boiler heating surface . .	149.65 sqm
Stroke . . . . .	660 ,,	Superheater heating surface	53.00 ,,
Driving wheel dia. . . .	1400 ,,	Total heating surface . .	202.65 ,,
Maximum speed . . . . .	60 km/hour	Feed water heater surface	15.0 ,,
Steam pressure . . . . .	12 at. gage	Weight empty . . . . .	65.5 tons
Grate area . . . . .	2.62 sqm	Service weight . . . . .	72.0 ,,

This brings the una-flow locomotive into a new phase of development, since the lower back pressure reduces the compression pressures and permits of the use of smaller clearance volumes. The exhaust ejector action also produces an approximately correct variation of the compression with the cut-off, since the energy available in the large toe of late cut-off cards produces a strong ejector effect, with a correspondingly low back pressure and a low compression pressure; while at early cut-offs the ejector action is less pronounced and the back pressure and terminal compression pressure are higher. In order to obtain the exhaust ejector effect a large exhaust lead is essential, and the latter at the same time shortens piston and cylinder. With this long duration of the exhaust only a small port area is required, with the result that the exhaust belt can be dispensed with and a considerable reduction in the weight of the cylinder and piston thus results. A comparison of Figs. 27 and 28 with the previous designs indicates how much more compact this construction has become. This is in part due to the use of horizontal single-beat poppet valves which were employed for the first time on this locomotive. This type of valve, although simple and perfectly steam tight, has so far not been favorably received because it requires a high lift and a large force to raise it. With the high compression of the una-flow engine, however, the pressure on the valve is balanced to a large extent and the high lift is obtained by arranging the cam roller between the valve stem and the fulcrum of the valve lever. The lift of the cam, which is 14 mm radially, is thus increased to 24 mm at the valve. For cut-offs up to 50% the effective inlet areas of the single-beat valve are equivalent to the areas of a standard piston valve of 220 mm diameter. The fact that beyond this cut-off the valve area remains constant must be considered a further advantage. The small cam lift permits of a cam profile of very gentle curvature, thus insuring smooth lifting and seating of the valve. The whole

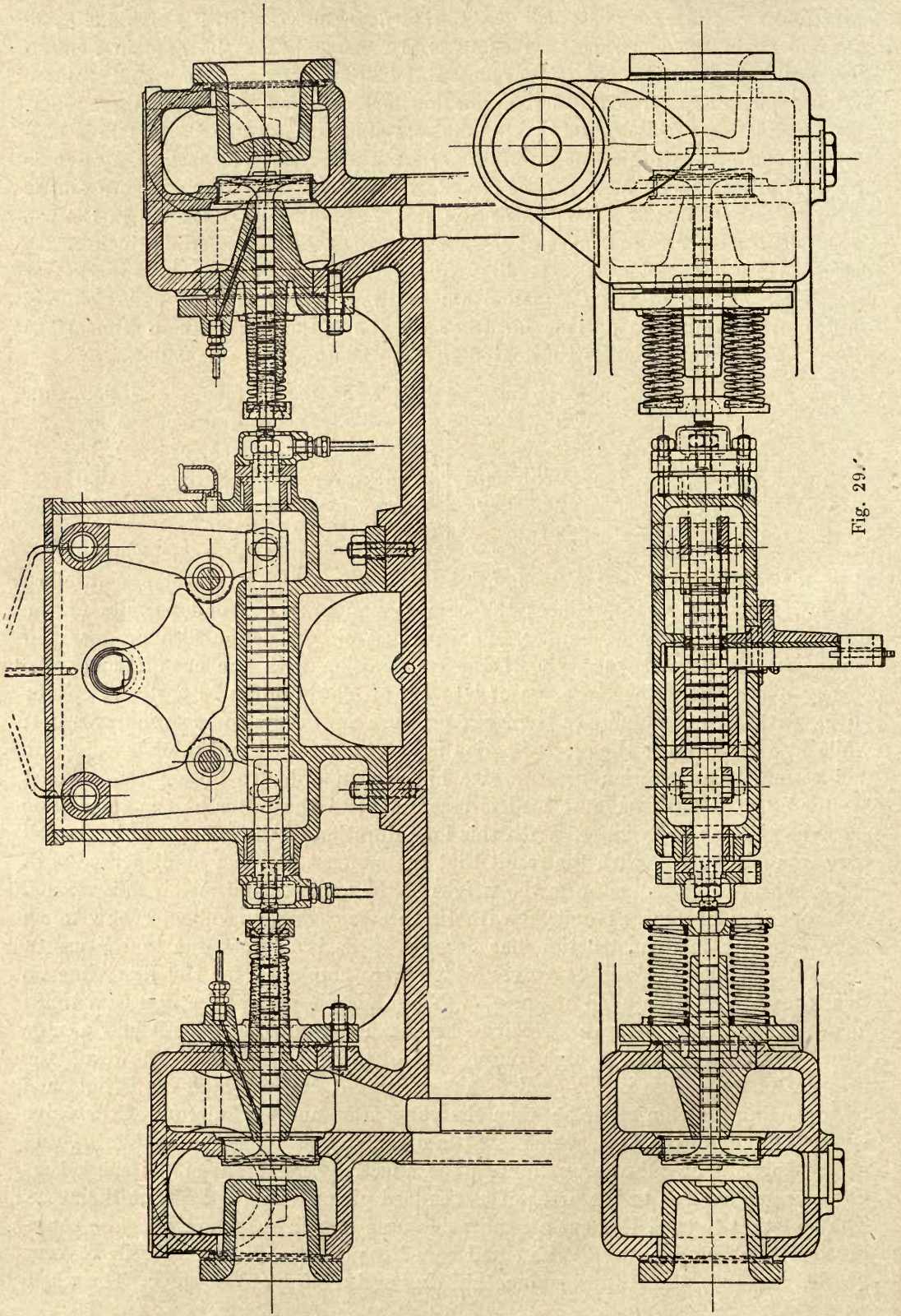


Fig. 29.

cam mechanism is very substantially constructed and swinging levers were used instead of sliding parts wherever possible. It should therefore stand up well in service.

The single beat valve is made of chrome-nickel steel and works on a removable steel seat expanded into the cylinder casting (Fig. 30). If this seat should become damaged by scale or other foreign matter it can be easily resurfaced or renewed. The valve stem has a diameter of 25 mm and is supplied with oil under pressure. The common center of gravity of the valve head and spring retainer is located at about the center of the guide so that good working conditions are assured. The valve stem furthermore is not exposed to the live steam but to the varying pressure and temperature of the cylinder steam. It is entirely independent of the cam mechanism except for the tappet contact, and is free to follow any slight distortion of the cylinder casting. Considering the success of the horizontal valves in the Lanz locomobile, which are double-beat in addition, the conclusion is justified that this is a very reliable construction.

When coasting, the valves may be lifted off their seats by compressed air admitted between small pistons formed on the valve tappets, so that the rollers clear the cam. Special means for connecting the cylinder ends are therefore not required, and the usual relief valves may be omitted, since the inlet valves act as such. They also relieve

the high compression which may occur when the throttle is nearly closed. The automatic compression release device also may become superfluous since the late cut-offs at starting produce a strong exhaust ejector effect and the compression is therefore considerably shortened.

Attention may be drawn to the accessibility of the valves; for their renewal it is only necessary to take off the valve chest cover and disconnect the valve spring, the spring cap lock being a split spherical washer. Comparing this with the procedure of taking out an ordinary piston valve, which requires frequent removal of carbonized oil, the great simplification due to the single beat valve will be appreciated.

The driving parts and the Walschaert gear are the same as those used on counterflow locomotives. On account of its greater length the cylinder was moved forward by 180 mm. The una-flow cylinder is not heavier than the corresponding counterflow cylinder, since the piston valve chest with its large exhaust chamber, as well as the tail rod and its guide are omitted. This allows the piston rod of 95 mm diameter to be bored out to a diameter of 60 mm, thus also saving weight. The forged steel piston heads, which are only slightly dished, hold between them a cast iron supporting drum cast from a special soft mixture, while the cylinder is made of a hard quality of cast iron. The supporting drum is turned smaller

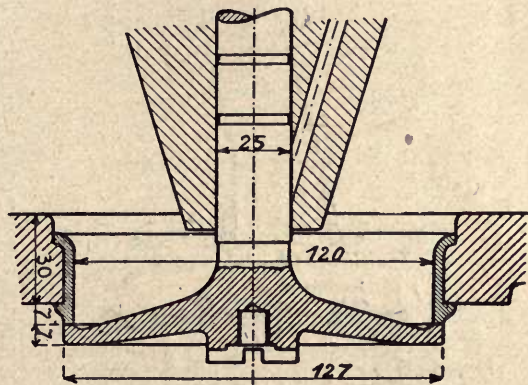


Fig. 30.

than the cylinder bore by 2,2 mm on a length of 140 mm at its middle, which allowance increases to 5 mm towards the ends. Each piston head carries three rings. The greater part of the total clearance volume of 12% is taken up by a linear clearance of 40 mm between piston and cylinder head, and this also results in very small harmful surfaces. The pressure oil feeds are arranged at the middle of the cylinder, where the temperature is lowest and little possibility of carbonizing exists. One feed is placed on top and one on each side at  $45^\circ$  below the horizontal center line.

It may be a matter of surprise that hardly anything is ever heard of attempts to utilize the energy of the exhaust steam of one cylinder to produce a vacuum in another. Such experiments have been made, for instance in connection with Kordina's blast pipe, but they were bound to fail in counterflow locomotives. As was shown in chapter I, 7, in dealing with the exhaust ejector effect, a large part of the available energy is required for producing the draft in the fire box, and if the energy is used in a wasteful fashion there will be nothing left for the reduction of back pressure. The ordinary counterflow cylinder has exhaust passages of such an uneven character that the steam continuously suffers changes of direction and velocity which naturally dissipate part of its energy. This is well shown by a comparison of Fig. 31 with Fig. 28. The una-flow cylinder is designed on the principle of conserving the exhaust energy, while in the counterflow design it might be thought that a dissipation of energy was aimed at. However, no blame for

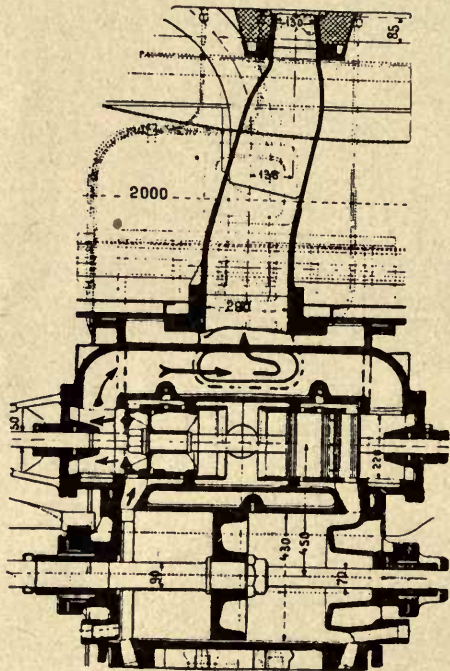


Fig. 31.

this can be laid on the designer, since tortuous and uneven exhaust passages are inseparable from the use of piston valves.

In consequence of these conditions, a certain pressure difference at the blast nozzle becomes necessary, since velocity must again be generated. It may be considered an excellent result if a pressure difference of 0,1 at. gage at the blast nozzle is found sufficient. In many cases, however, the kinetic energy is dissipated to such an extent that there is not enough left to cover the blast pipe loss. The latter can only be diminished by a reduction of the velocity. Since the blast pipe area is fixed, this reduction of velocity can only be accomplished by a diminution of the volume, which thus leads to an increase of pressure. In this way the back pressure in piston valve cylinders occasionally rises to 0,5 at. In contrast to this condition, a back pressure of 0,5 at. below atmosphere is aimed at with the ejector effect of the una-flow exhaust for late cut-offs.



Although the possibility of the utilization of the exhaust energy for the purpose of reducing the back pressure has no inherent connection with the un-a-flow principle, it is limited to the latter by virtue of the conditions of exhaust whereby the energy is conserved, and it must therefore be considered an integral part of the same.

The exhaust opening in the cylinder wall is in the shape of a nozzle which is dimensioned in such a way that in combination with the rounded edge of the piston an approximately correct nozzle area for any particular pressure drop is obtained, when assuming average pressure and speed conditions. The remaining pressure energy is therefore transformed into kinetic energy and thus reaches the blast nozzle with the least possible friction losses. Even for full opening there is a certain amount of divergence in the exhaust nozzle. At the junction of the

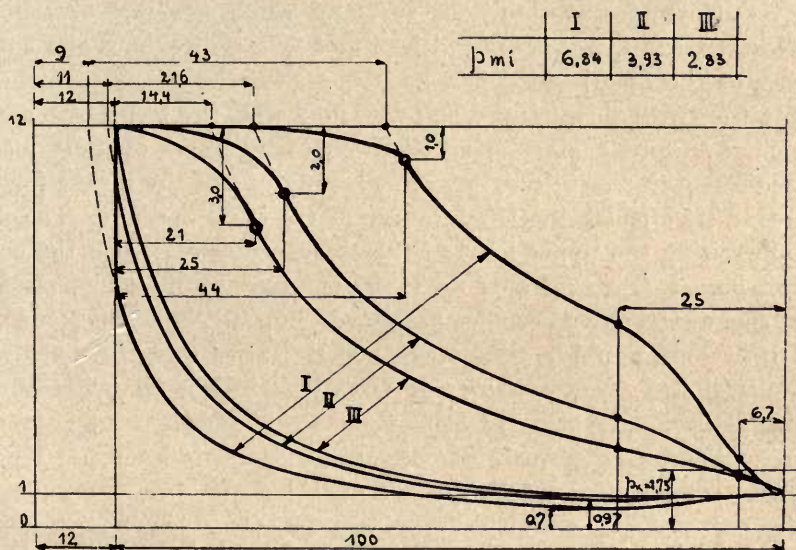


Fig. 32.

two exhaust pipes the section suddenly doubles, and from this point on the pipe diverges to the blast nozzle and thus acts as a kind of diffusor. The steam for the feed water heater is withdrawn from the cylinders by separate nozzles, and the pipes from them lead to a common ejector nozzle similarly to the main exhaust pipes.

It was of course important to make the blast pipe section as large as possible in order to reduce the blast pipe loss. The stack was therefore designed with the most favorable dimensions, its diameters being 460 and 610 mm as compared with 410 and 460 mm of that of the standard engine. The possibility therefore arose that the jet leaving the blast nozzle, which was dimensioned to obtain a diffusor action, would not spread out sufficiently to fill out the stack section. This danger is especially great in this case, since the jet has very little internal pressure and spreads out to only a comparatively small extent. If the stack is not completely filled with steam, air enters the smoke box from above and thus

partially destroys the vacuum. In order to prevent this, the jet may be divided by ribs in the nozzle into smaller diverging jets, which spread out and again join in the stack (Fig. 28). In actual operation however the ribs proved to be superfluous.

The effect of the ejector action is shown in the diagrams of Fig. 32, which were drawn for an evaporation of 7000 kg/hour and for speeds of 20, 40 and 60 km/hour, under very conservative assumptions. The clearance volume was assumed to be 12%, so that the compression would not exceed the initial pressure even without the exhaust ejector action. It will be seen from the diagram that the ejector effect only begins after a piston travel of 6,7%, since in a two cylinder locomotive the cylinders are in connection only during a short part of the stroke, and therefore only part of the exhaust energy can be utilized for producing the ejector effect. It was shown in chapter I, 7, how much greater the gain would be with a three cylinder locomotive, especially when working with high mean effective pressures, since in this case with proper length of exhaust lead the whole of the energy of the diagram toe can be utilized for the exhaust ejector action.

In connection with this, it may be mentioned that the trend of modern locomotive design is toward an increasing adoption of the three cylinder locomotive.

The exhaust ejector principle, however, is only one of the means for reducing the volume loss, its effect being the lowering of the back pressure. The next step will consist in raising the upper limit of the steam pressure. With the customary design of fire box, steam pressures up to 16 at. gage are possible, although the number and size of the stays becomes excessive. For still higher pressures a different design of fire-box would be necessary, such as for instance a box of the Brotan type, which permits of steam pressures of 20 at. gauge. The following table shows that by raising the steam pressure from 12 to 20 at. gage, the amount of heat which can be converted into work increases from 116 to 146 cal. per 1 kg steam. This represents a gain of about 26%.

	Boiler pressure at gauge	Live steam			Exhaust steam		Heat converted into work Cal.	Satur- ation point at. abs.	Clear- ance volume %
		Cylinder pressure at gauge	Temp. at Cylinder °C	Total heat Cal.	Back pressure at. abs.	Total heat Cal.			
Counter-flow	12	11	320	740	1,15	624	116	2,2	10
Una-flow	20	19	320	734	0.85	588	146	4.75	7

This remarkable result can only be attained by employing the una-flow principle, since the pressure at which the steam becomes saturated increases from 2.2 to 4.75 at. abs. and during a considerable part of the expansion moisture is therefore formed in the cylinder. This does not have much effect upon the economy of the una-flow engine but is very detrimental to that of the counterflow cylinder where the presence of moisture causes large surface losses.

The practice with counterflow locomotives is therefore to use higher superheat with higher initial pressure. The increase in temperature, however, is the cause

of many difficulties with piston valves and piston rod packings. Furthermore, the superheater elements must be shortened so that the flue gases do not exert a cooling effect upon the superheated steam. This in turn leads to a great number of superheater elements and inefficient utilization of space. The una-flow engine can of course be adapted to meet this condition in a better manner, since its design makes it more suitable for high temperatures than the customary counterflow cylinder with piston valves. On the other hand there is no necessity for using these high temperatures in the high pressure una-flow locomotive, since the una-flow action corrects the bad influence of moisture in the steam.

The calculated gain of 26% of the high pressure una-flow locomotive with exhaust ejector action will probably be exceeded in practice, since it does not include the benefit due to the single beat poppet valves, the reduction of the clearance volume to 7%, nor even the gain due to the una-flow principle itself.

The future line of progress of the locomotive is therefore clear. It leads naturally from the two-cylinder to the three-cylinder engine with una-flow cylinders having small clearance volumes, to the use of single-beat poppet valves and the utilization of the ejector action of the exhaust, in combination with high pressures and high superheat.

## IV. The Una-Flow Locomobile and Portable Engine.

The una-flow engine is especially suitable for locomobiles and portable engines. Simplicity, lightness, cheapness and economical use of steam are demanded of this type of engine, light weight being particularly required for portable and self propelled machines. All these requirements are satisfied by the una-flow engine.

Figs. 1 to 3 illustrate the construction employed by the Maschinenfabrik Badenia vorm. Wm. Platz Söhne, A.-G., Weinheim (Baden).

In comparison with the usual design of locomobile with a tandem engine, there is a saving due to the omission of one cylinder with all its accessories. Compared with the usual type of compound poppet valve locomobile, one complete driving unit and two valves on the remaining cylinder are dispensed with. While the una-flow locomobile engine has only two valves, the compound locomobile requires eight. The omission of exhaust valves is of particular advantage. The cylinder may therefore be mounted directly on the boiler, and the two inlet valves may be arranged vertically in the heads (Fig. 4). These valves are operated by an eccentric mounted on the crank shaft next to the flywheel, controlled by the flywheel governor. The motion is transmitted to the valves in the same manner as on stationary una-flow engines. Bolted to the cylinder is a frame of the forked type which carries the center crank shaft. On the free ends of the shaft are mounted two overhung flywheels, one of which carries the governor and the other is provided with teeth for the barring device (Fig. 5). Provision is made in the design for interchanging the two flywheels so that the condenser may be placed either to the right or the left of the engine. All the parts concerned are constructed in such a way as to make them suitable for either method of setting up, and a good basis for large scale production is therefore obtained.

The air pump is placed vertically and is driven from a crank pin on the flywheel.

Una-flow locomobiles are built for condensing service as well as atmospheric exhaust. In the former case, non-condensing operation is provided for by the employment of auxiliary clearance pockets.

The reciprocating masses are partially balanced by counterweights on the crank cheeks and in the flywheels.

The governor shown in Figs. 6 and 7 has two weights pivoted on two pins fixed on the flywheel. These weights are in the form of bell crank levers, the short arms of which carry rollers bearing on the thrust washer of a central spring common to both. The long arm of each weight is provided with a pin at its extreme end, but only one of them is used for the connection to the shifting eccentric. The free weight, however, also takes part in moving the eccentric to the extent that it bears more strongly on the spring plate and thus relieves the second weight,

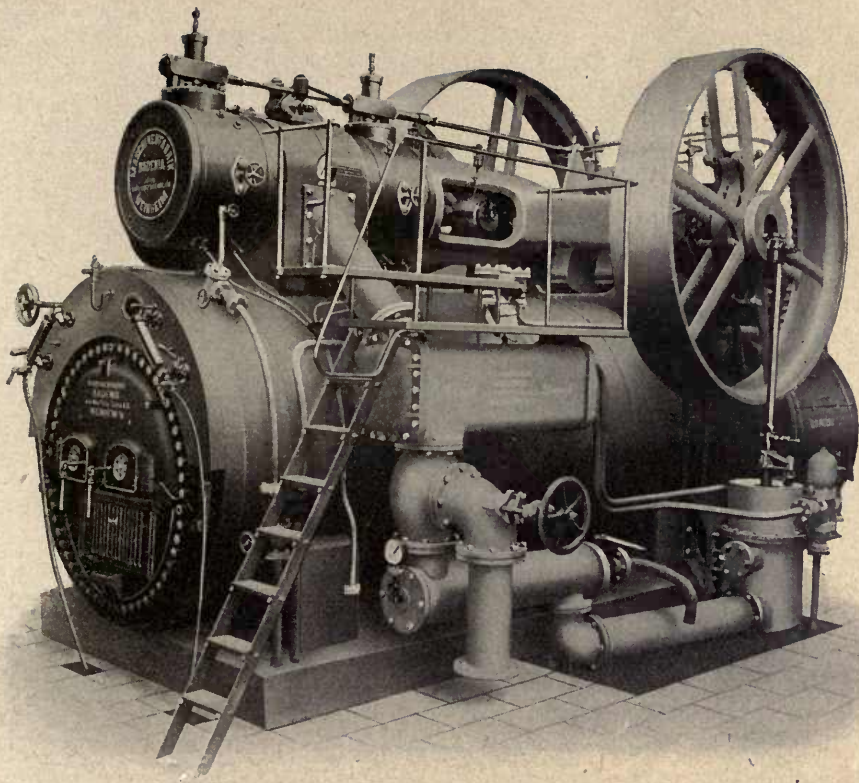


Fig. 1.

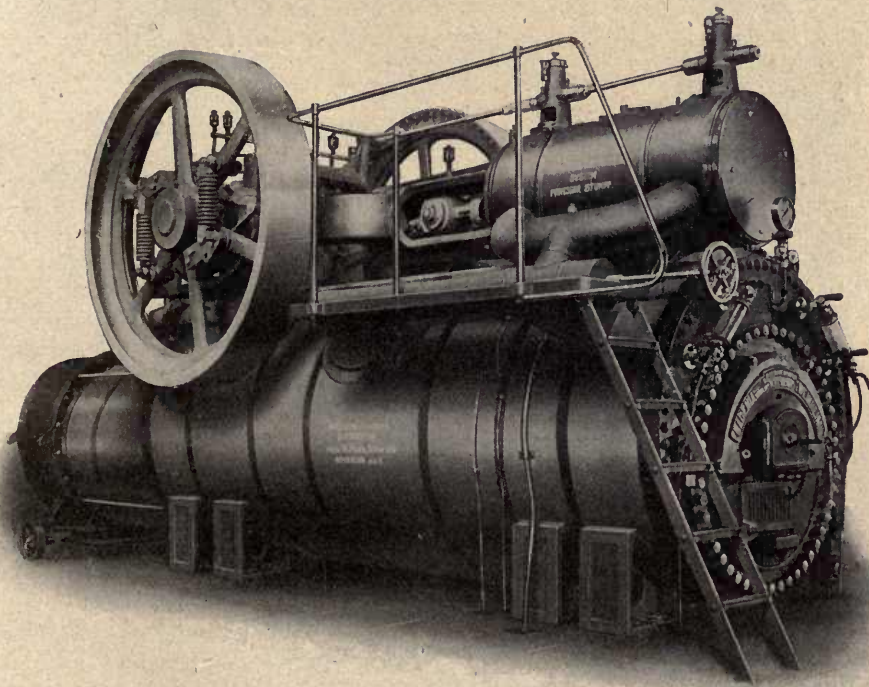


Fig. 2.

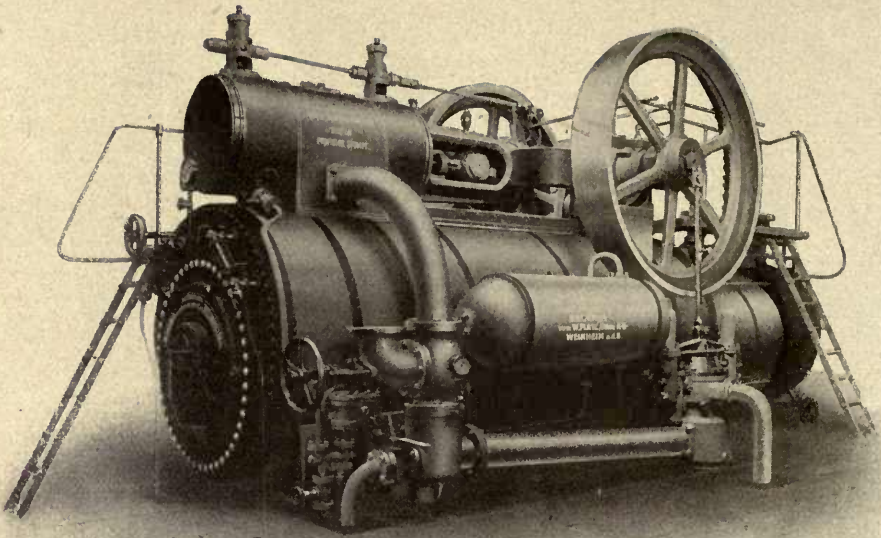


Fig. 3.

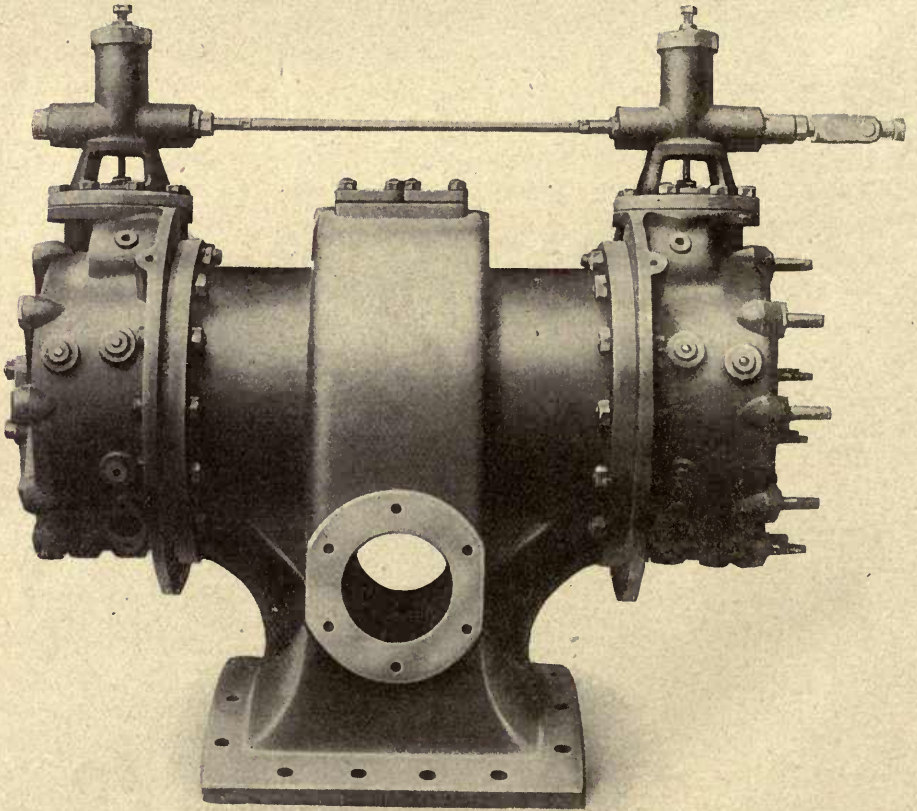


Fig. 4.

which therefore has a larger force available for shifting the eccentric. The primary eccentric is provided with tapped holes so that it may be turned through an angle of  $180^\circ - 2\delta$  ( $\delta$  being the angle of advance), and bolted in this position. If the shifting eccentric is at the same time swung around and its connecting link attached to the other weight, the governor is then changed over for a left hand engine. This change can therefore be made without any alteration in the parts concerned. This governor is obviously only suited for high speeds, since the natural oscillations due to the weights themselves would be detrimental to regulation at low speeds.

This type of governor, although now no longer used, is mentioned here in order to demonstrate the conditions which must be satisfied by a locomobile governor from the point of view of its suitability for a variety of uses.

The movement of the shifting eccentric is transmitted to the valves by a rocking lever and cam and roller motion in the manner previously described. It is advisable to make the rocking lever in one piece of cast steel.

In Fig. 8 is shown the assembly of a 100 HP locomobile, also built by the Badenia Company. The cylinder is bolted to the boiler and is in rigid connection with the main bearings through the forked frame. The bearing housings rest on half-round pieces of steel, so that free expansion of the boiler and correct alignment of the shaft are assured. This feature has been patented by the builders. The bearings are of double construction, so that the inner halves on the one hand closely support the crank arms and take the steam load, while the outer halves carry the flywheel load. Chain lubrication is provided for in the center of each double bearing. One of the flywheels is cast with teeth for barring purposes and the other carries the shaft governor described above. The additional clearance pockets which are provided to allow the engine to be run non-condensing are arranged in the cylinder heads. The exhaust belt of the cylinder has an extension forming a base which is bolted to the boiler. The exhaust belt has an opening on either side for the connection to the condenser. The flywheels, frame, bearings, cylinders and heads, condenser, all the valve gear parts, governor, barring device, feed water heater, change-over valves, and all accessories are constructed in such a manner as to allow of either a right or left hand arrangement, to provide for condensing or non-condensing service, and to suit either direction of rotation, according to the purchaser's wishes. The chief features which render the unaf-flow engine of particular value for locomobiles are the central mounting of the cylinder on the boiler, the arrangement of the valve gear on the cylinder, the well balanced connection between the shaft bearings through the forked frame to the cylinder, the freedom of relative expansion between boiler and frame, and the simplicity of the entire construction.

The excellent superheater designs of the Maschinenfabrik Badenia shown in Figs. 9 and 10 are worthy of note. The advantages of this design are small throttling losses, large capacity per unit of surface, and accessibility of the superheater and boiler tubes. The superheater is mounted at the smoke box end of the boiler in such a manner that the area in front of the flue tubes is left free for access to the latter (Fig. 9).

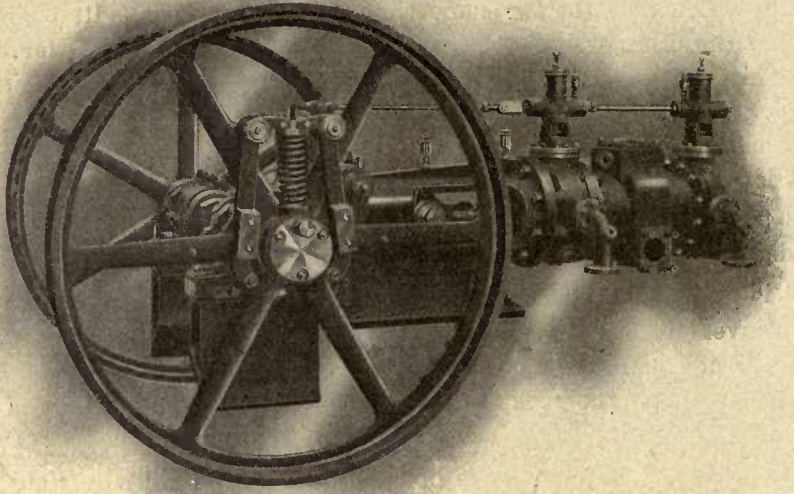


Fig. 5.

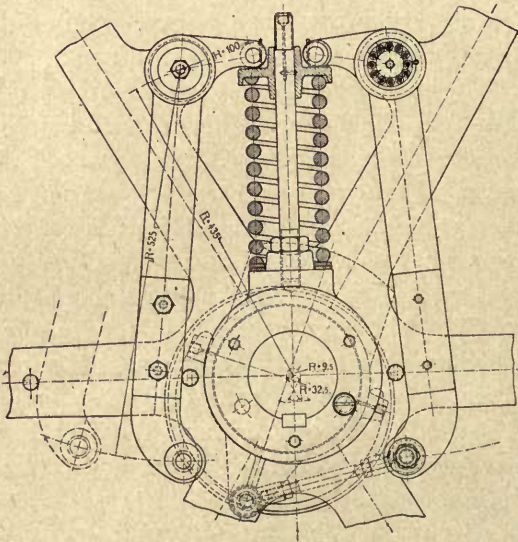


Fig. 6.

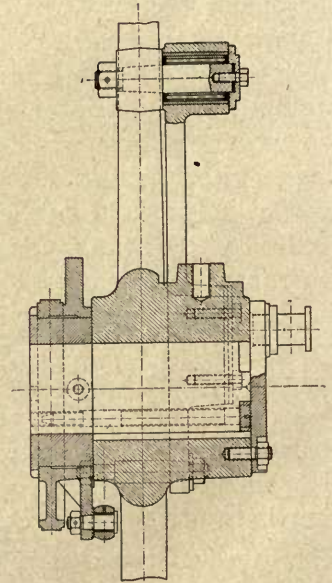


Fig. 7.



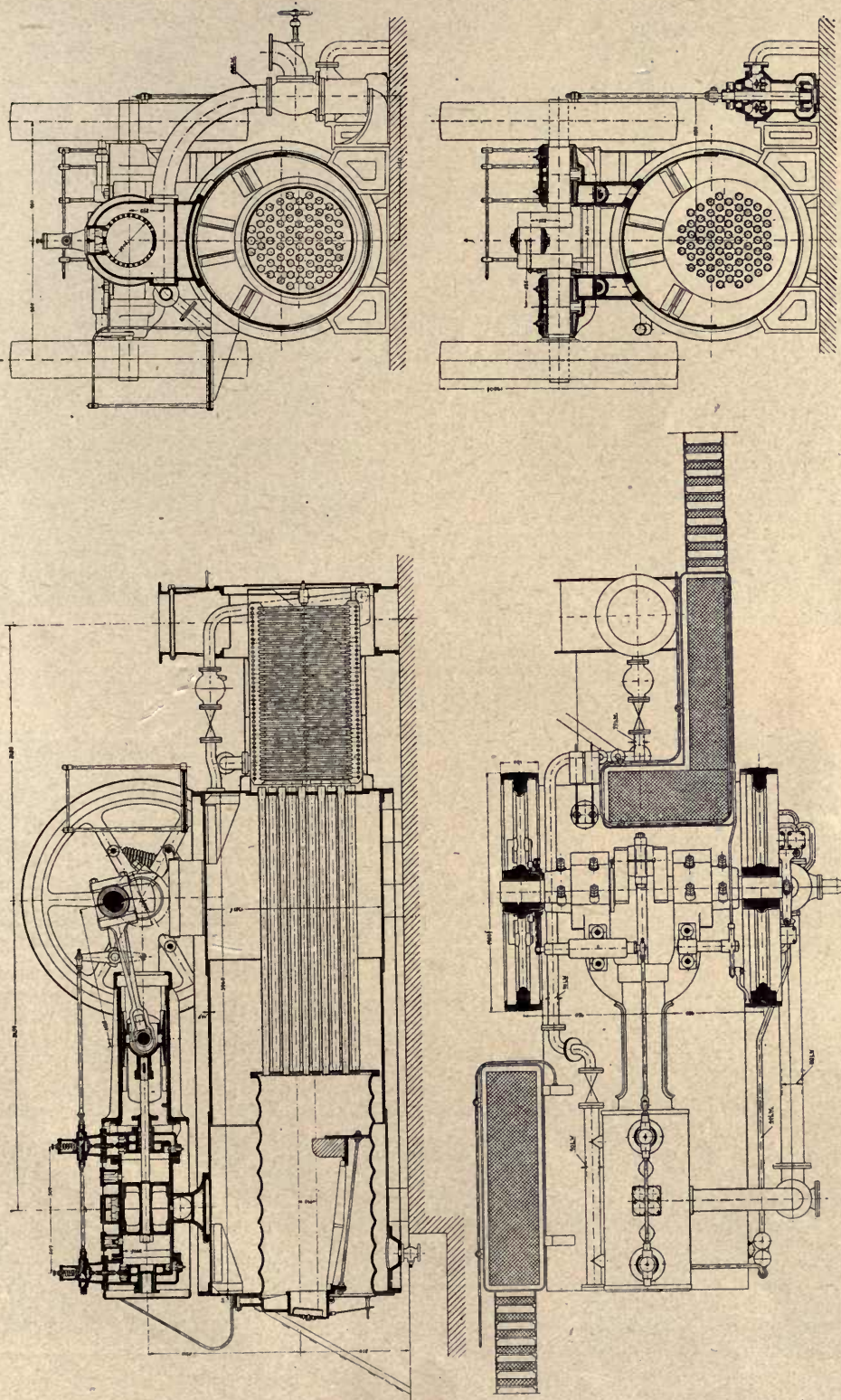


Fig. 8.

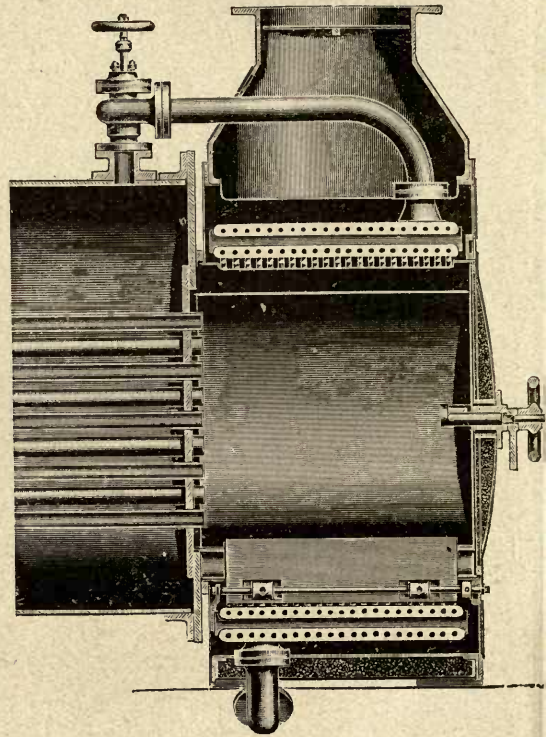
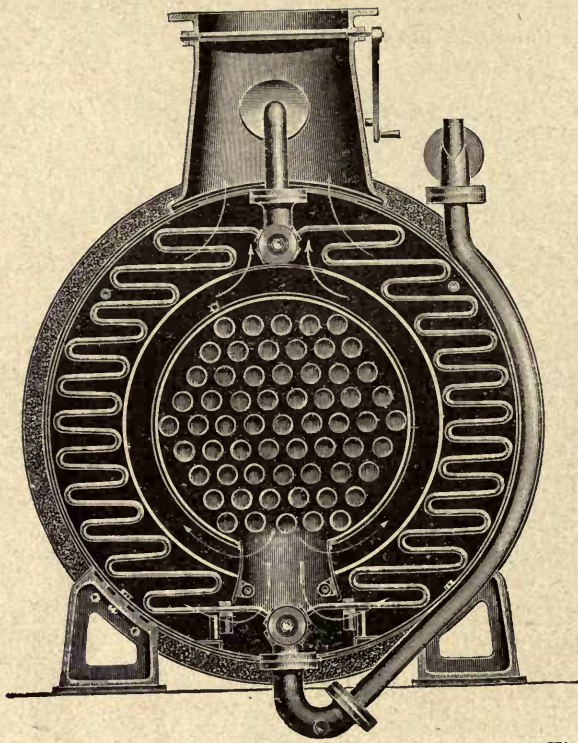


Fig. 9.

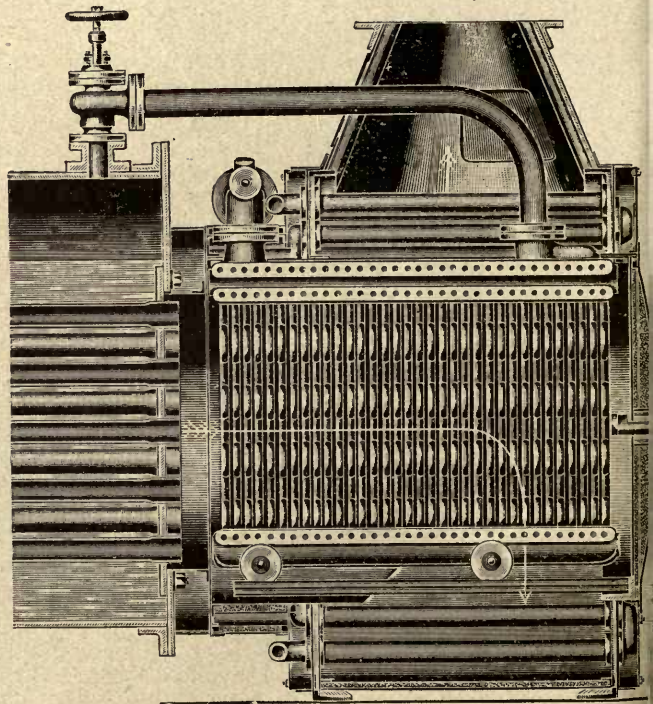
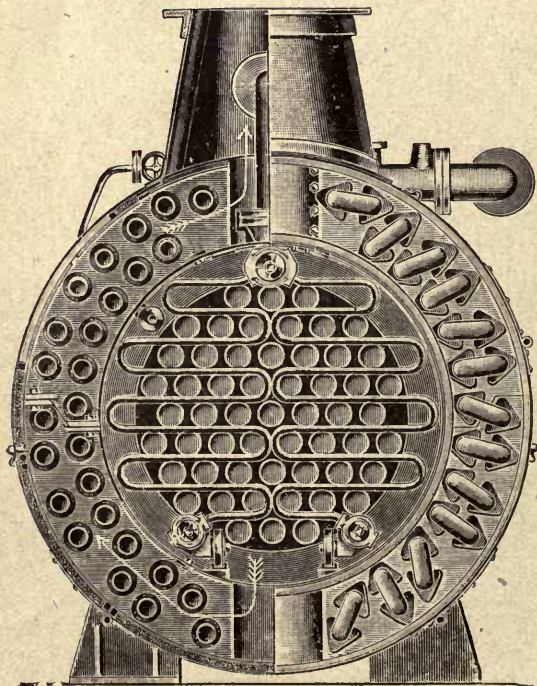


Fig. 10.

In the construction shown in Fig. 10 the same result is attained by arranging the superheater tubes in a winding fashion back and forth between the flues, so that the latter are still accessible.

Figs. 11, 12 and 13 illustrate later designs by the same builders which show greater care in the support of the crosshead guides and the main bearings, as well

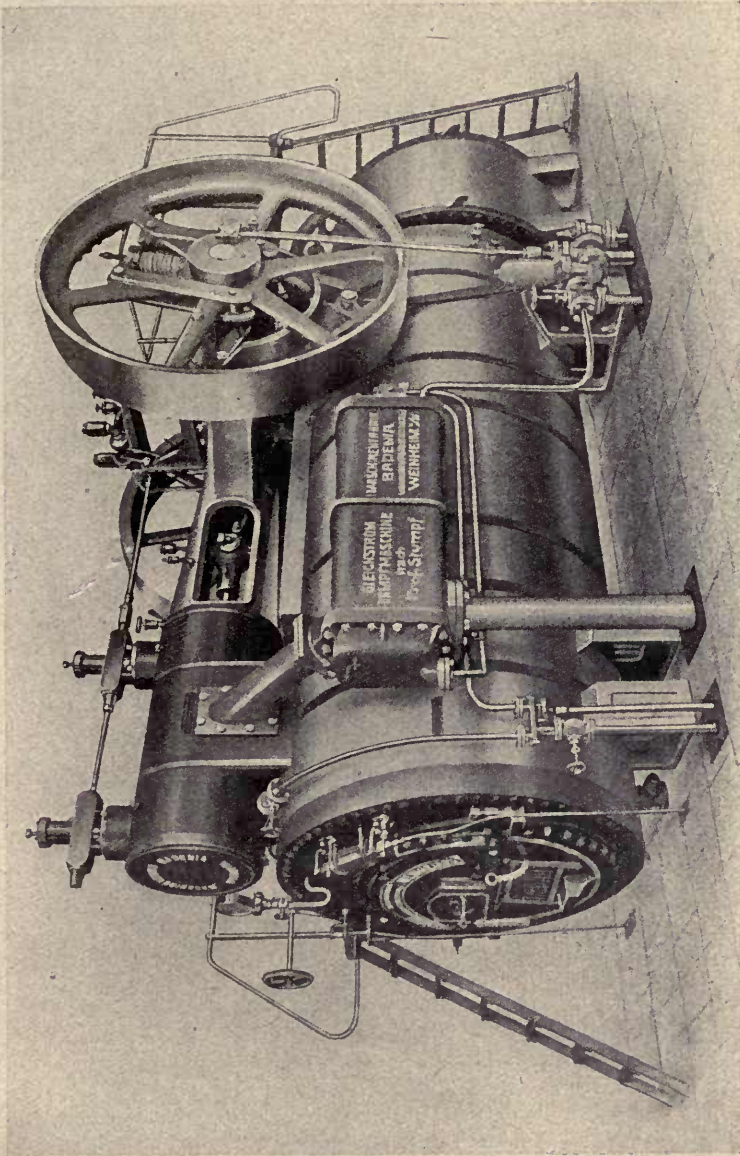


Fig. 11.

as increased area of the exhaust openings. The unbalanced vertical centrifugal forces of the counterweights are transmitted from the main bearings through supporting columns to the foundations. More latitude is therefore allowed in the proportioning of the counterweights.

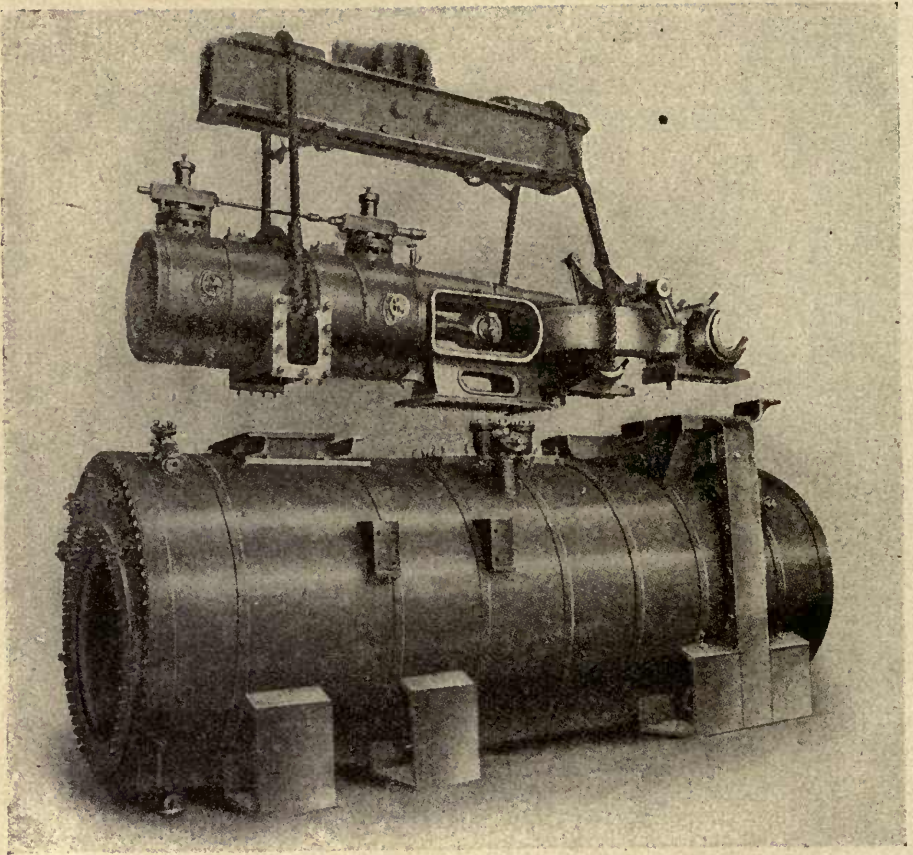


Fig. 12.

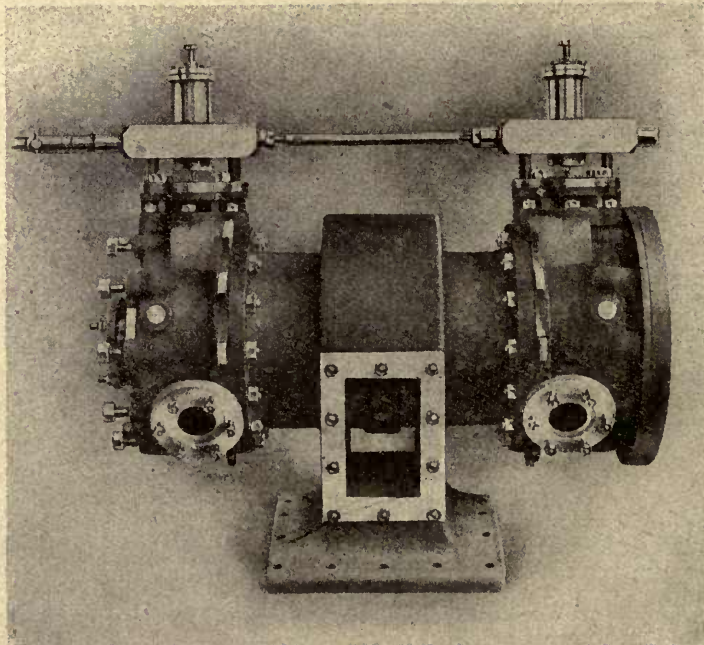


Fig. 13.

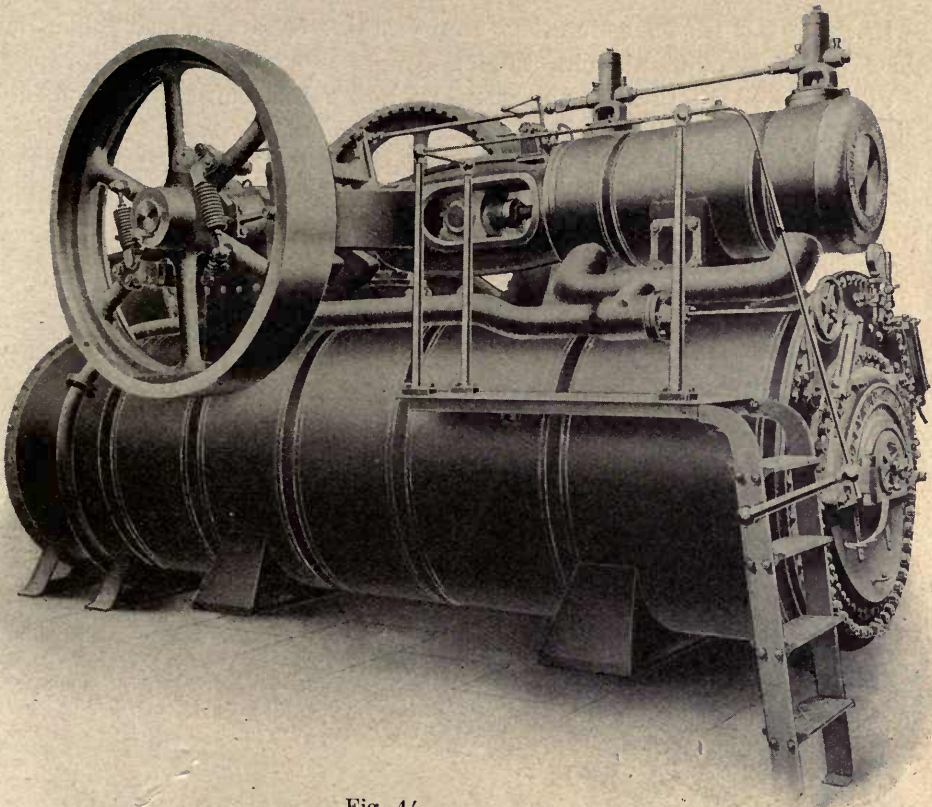


Fig. 14.

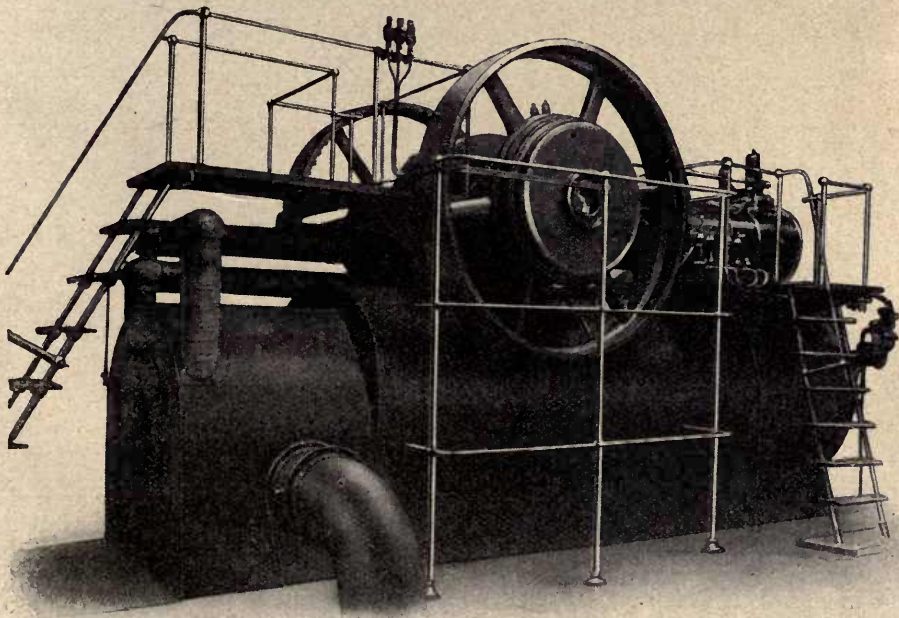


Fig. 15.

In Fig. 14 is shown a una-flow semi-portable engine or locomobile, built by Robey & Co., Ltd., of Lincoln, England.

Figs. 15 and 16 illustrate a una-flow locomobile constructed by the Erste Brünnner Maschinenfabrik, of Brünn, Czecho-Slovakia.

In Figs. 17 to 19 are shown the general arrangement, cylinder design and valve gear diagrams of an agricultural una-flow portable engine built by the Kolomna

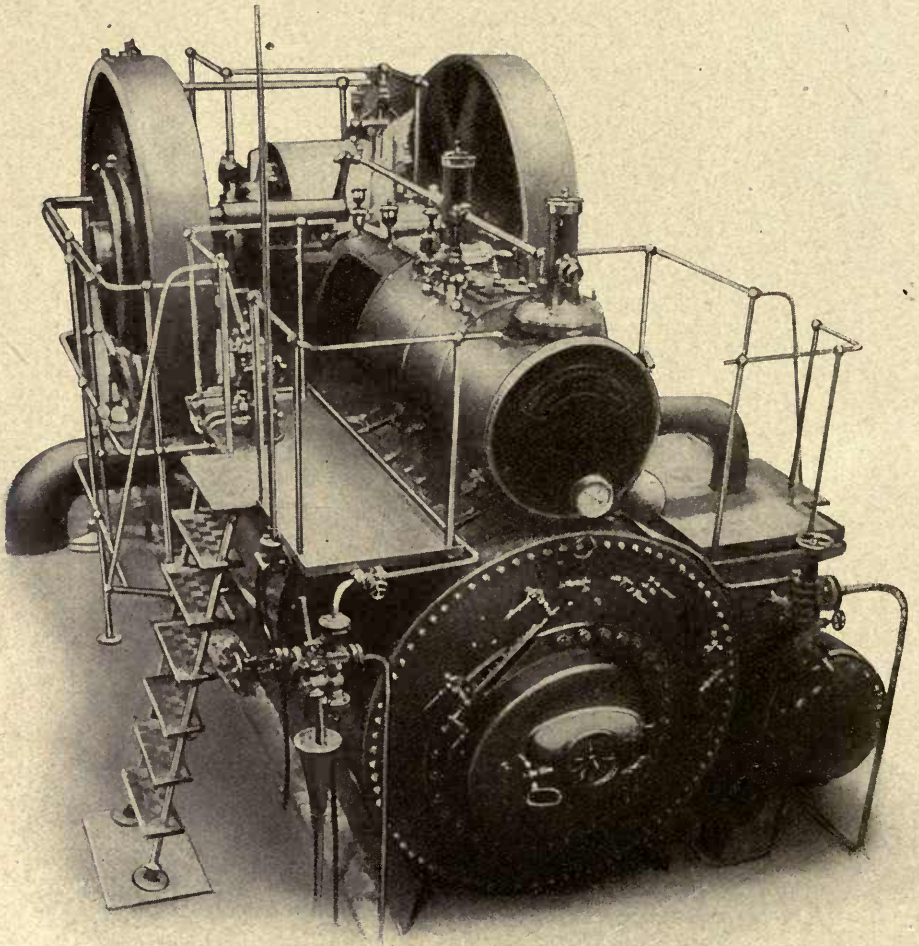


Fig. 16.

Engine Works, of Kolomna, near Moscow. This type of engine must necessarily be of cheap and simple construction, and yet answer all the demands put upon it. With this in view, the single-beat valves are arranged horizontally, with an operating mechanism common to both. This consists of a three-armed rocking cam lever, one arm of which projects between the ends of the valve stems. The others are formed with cam profiles, by means of which it is rocked back and forth by contact with the roller of a swinging lever mounted on a shaft above it. The

latter is operated by a lever and link from a shifting eccentric controlled by a shaft governor. The whole of the cam mechanism runs in oil and is enclosed in a housing cast onto the exhaust belt. The cover of the housing is adapted to support the smoke stack of the boiler when it is not in use. In this small type of engine, unbalanced single-beat valves are used, and these are made in one piece with their

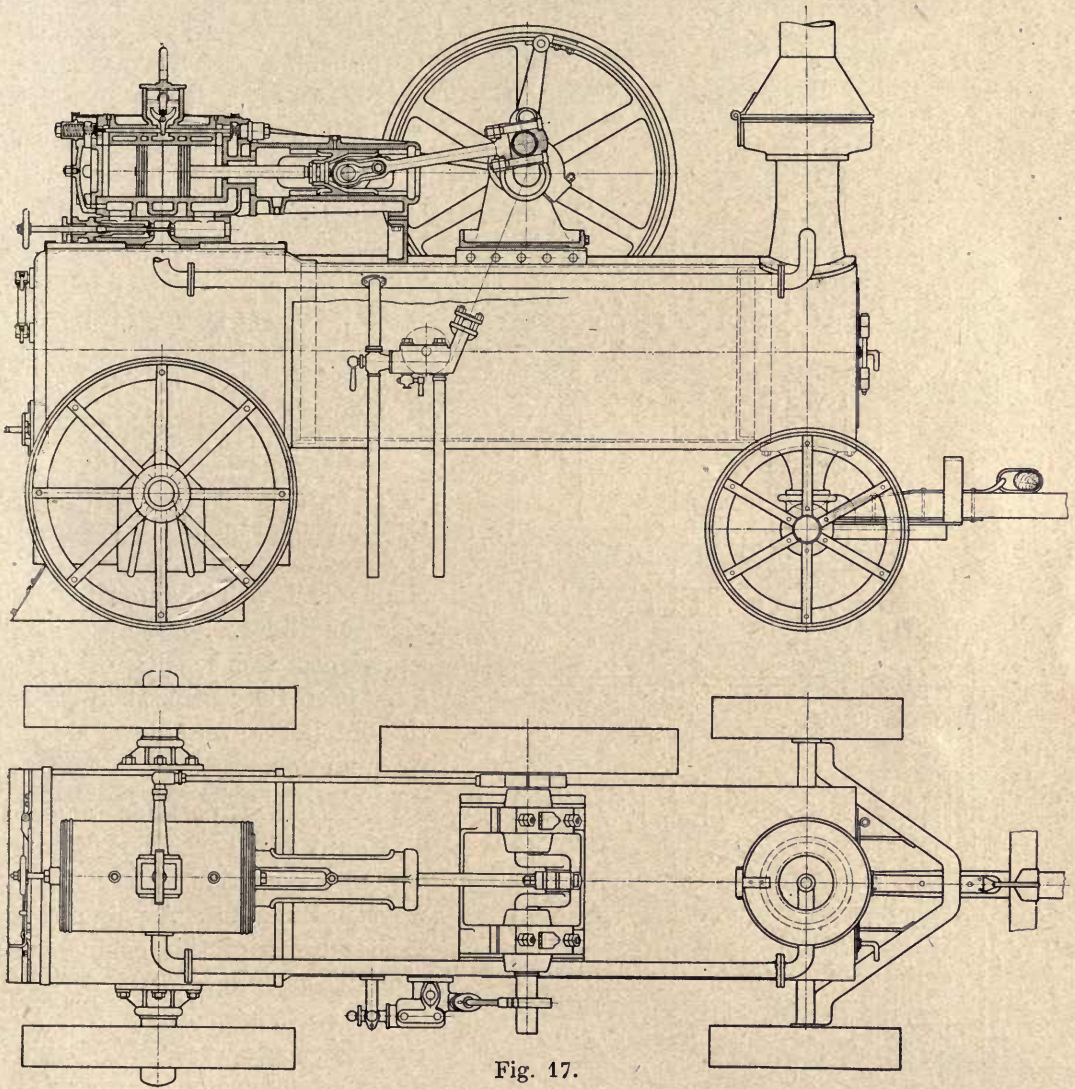


Fig. 17.

stems. The horizontal arrangement of the valves was adopted in order to obtain a simple drive common to both of them. The cylinder is cast in one piece with the crank end head.

This engine was designed for use with saturated steam of 10 at. pressure. In accordance with the results of previous tests, the heads as well as the ends of the cylinder barrel were well jacketed. A neutral, unheated zone extends between the cylinder jackets and the central exhaust belt.

The cylinder rests on a casting (Fig. 20) which at the same time forms a housing for the stop valve and distributes the steam to the ends of the cylinder. The passages in this casting are so arranged that the water of condensation from the jackets may run back to the boiler.

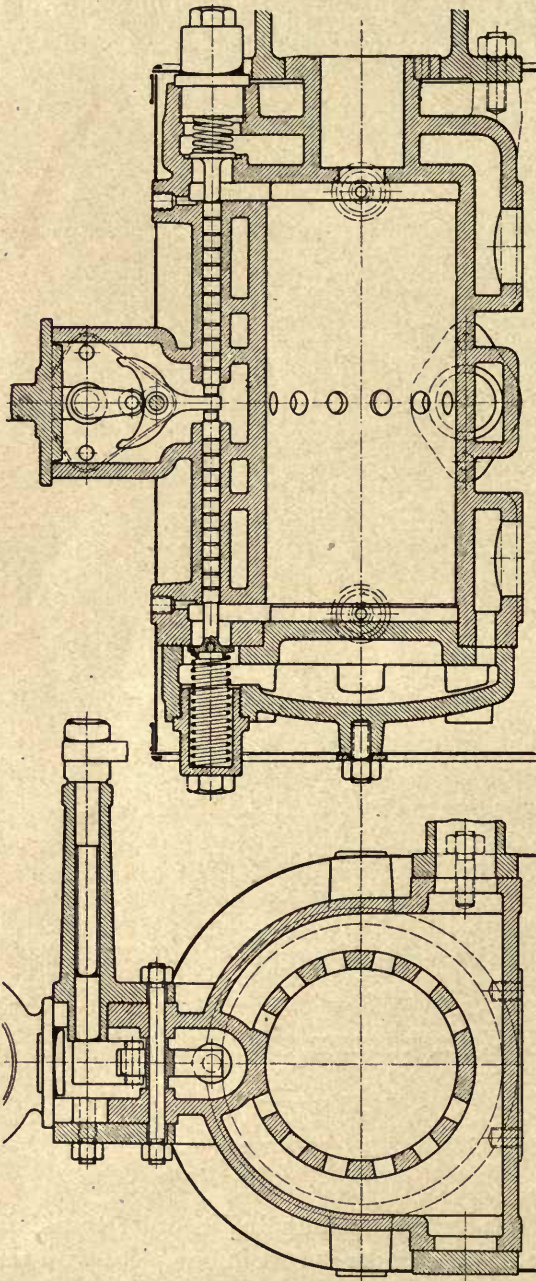


Fig. 18.

The piston is made in two parts, with bowl-shaped ends to accommodate the necessary clearance space.

In Figs. 21 to 26 are shown details of the crosshead guides, stuffing box, crosshead, connecting rod, main bearings and crank shaft.

The boiler is provided with a fire box of large size, so that straw and wood may be used for fuel.

The assembly drawing of Fig. 17 and the half-tone illustration of Fig. 27 show that the construction is extremely simple and well adapted to service conditions. All the previous experience and results of tests have been fully utilized in order to obtain a very low steam consumption.

A similar portable engine was built by the Engine Works of the Hungarian State Railways in Budapest. A pair of indicator cards of this engine are reproduced in Fig. 28, and the cylinder is shown in Fig. 30. To permit of the use of a small clearance volume, steam operated auxiliary exhaust valves (Fig. 29) are provided near the ends of the piston travel. To the end of each valve spindle is attached a

spring loaded piston, the outer side of which is connected by a pipe to the clearance space of the corresponding cylinder end. During admission and expansion, the high steam pressure acting on the valve piston holds the valve closed, but as soon as the pressure is relieved through the exhaust ports, the valve



is opened by its spring. The steam remaining in the cylinder is then swept out by the piston until the latter overruns the passage leading to the auxiliary exhaust valve, and compression begins. The compression pressure, assisted by the subsequent admission of live steam, then closes the valve. Steam dashpots are used to make these valves quiet in operation. The piston rod stuffing box is also worthy of notice. All the details of this engine, including the auxiliary exhaust valves, have proved very satisfactory in service. The action of the exhaust valves, as

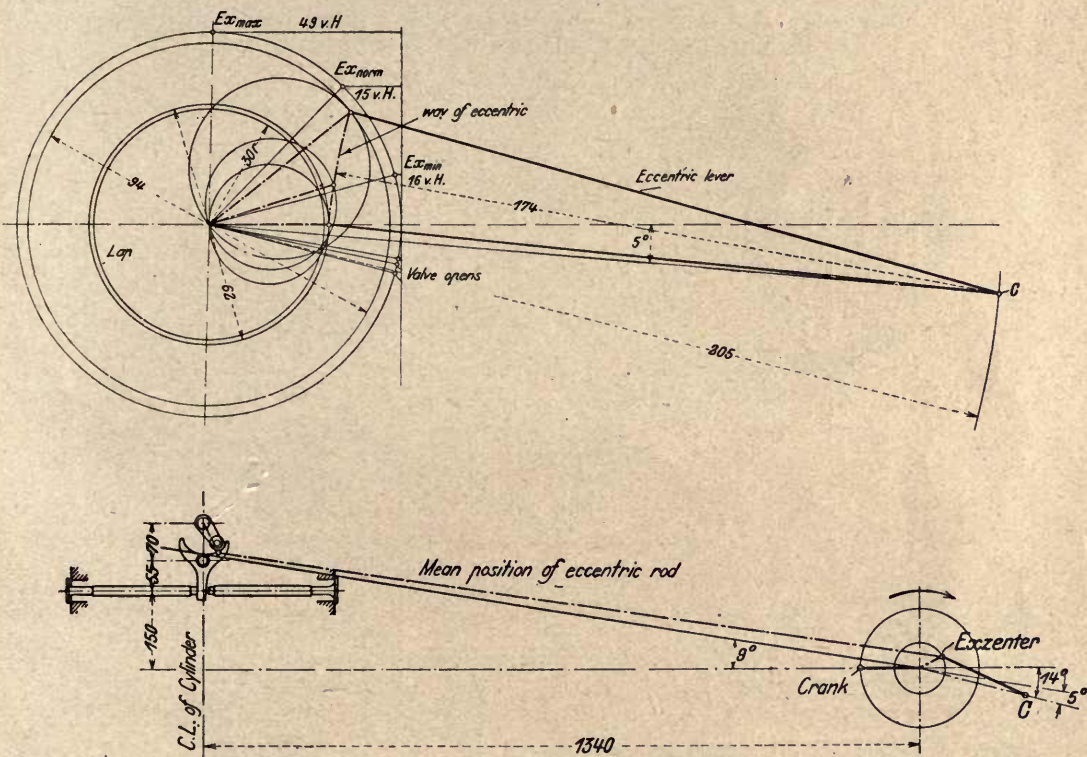


Fig. 19.

well as the effect of too large an exhaust port area, is distinctly noticeable in the indicator cards of Fig. 28. The steam consumption is low, as is shown by the following test results:

Date . . . . .	Feb. 25, 1914
Duration of test . . . . .	min 420
Feed water used, total . . . . .	kg 1424
"    "    "    per hour . . . . .	"    203.42
"    "    "    "    and per 1 sqm heating surface . . . . .	"    24.1
Temperature in feed water tank, mean . . . . .	°C 25.5
Coal used, total . . . . .	kg 400
"    "    per hour . . . . .	"    57.14
"    "    "    "    & per 1 sqm grate area, mean . . . . .	"    168

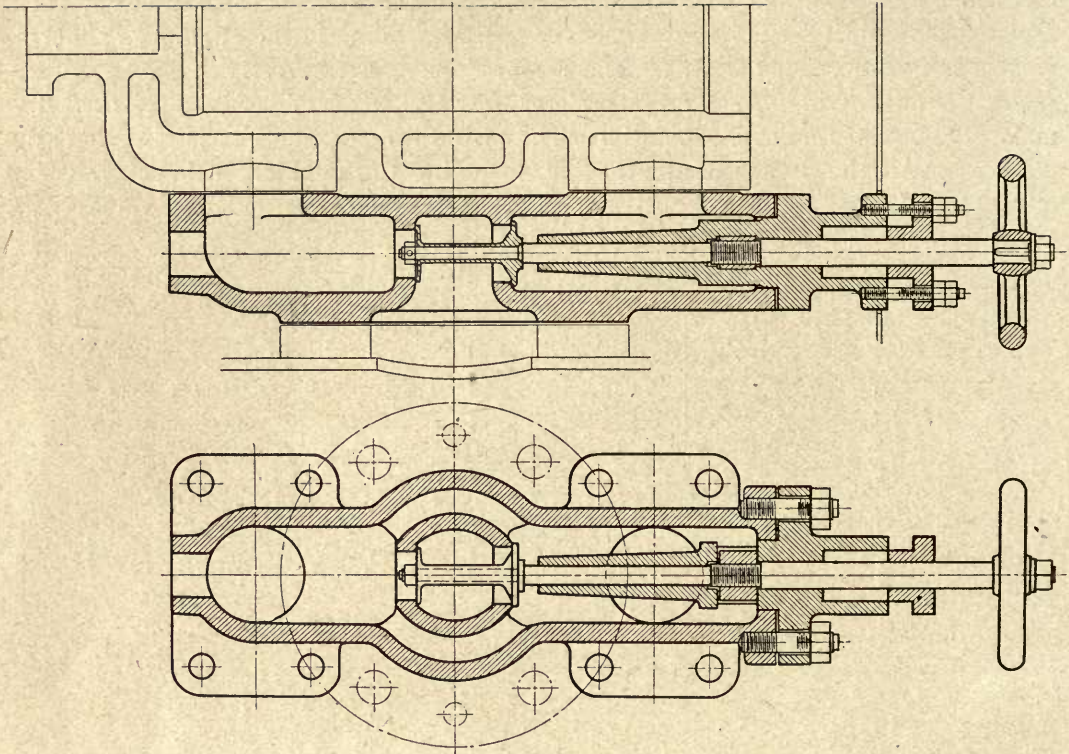


Fig. 20.

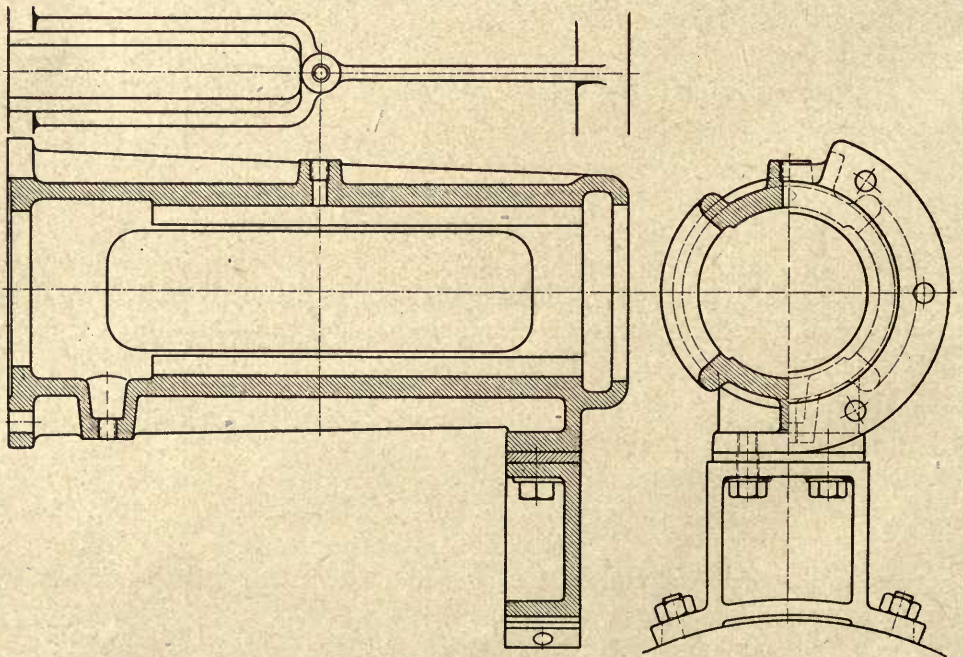


Fig. 21.

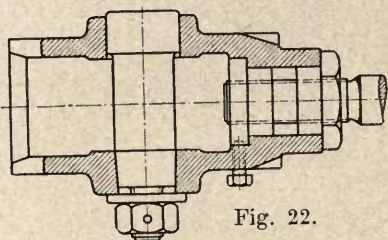
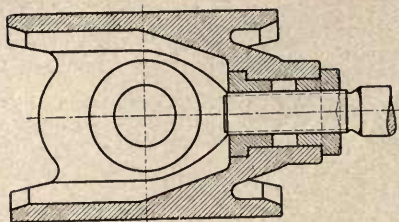


Fig. 22.

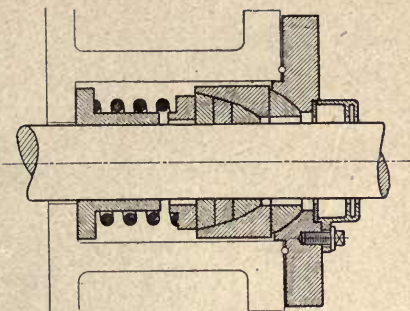


Fig. 23.

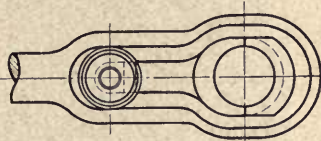
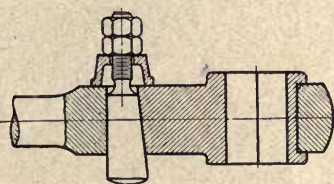
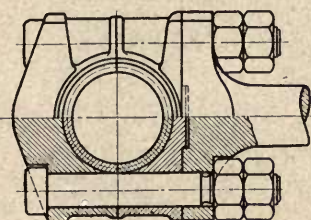


Fig. 24

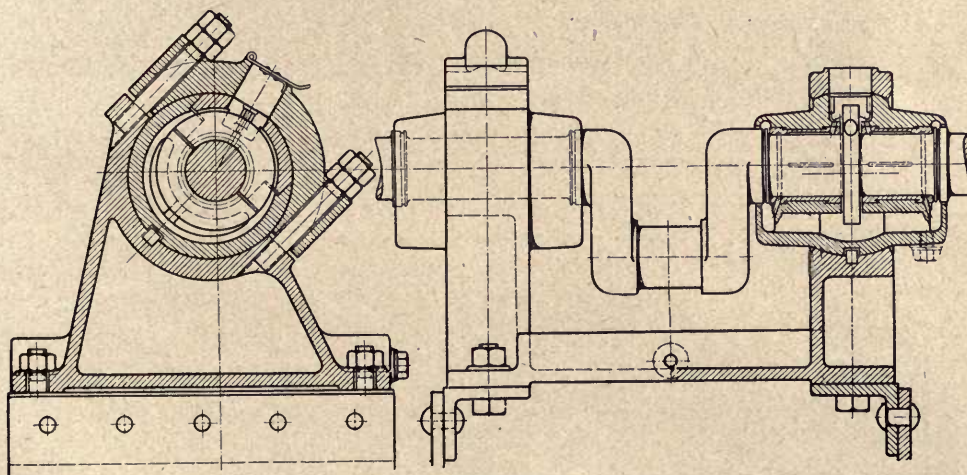


Fig. 25.

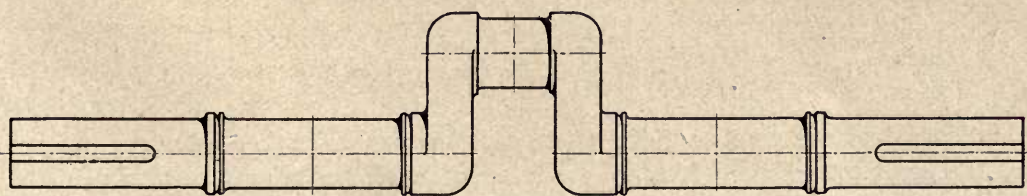


Fig. 26.

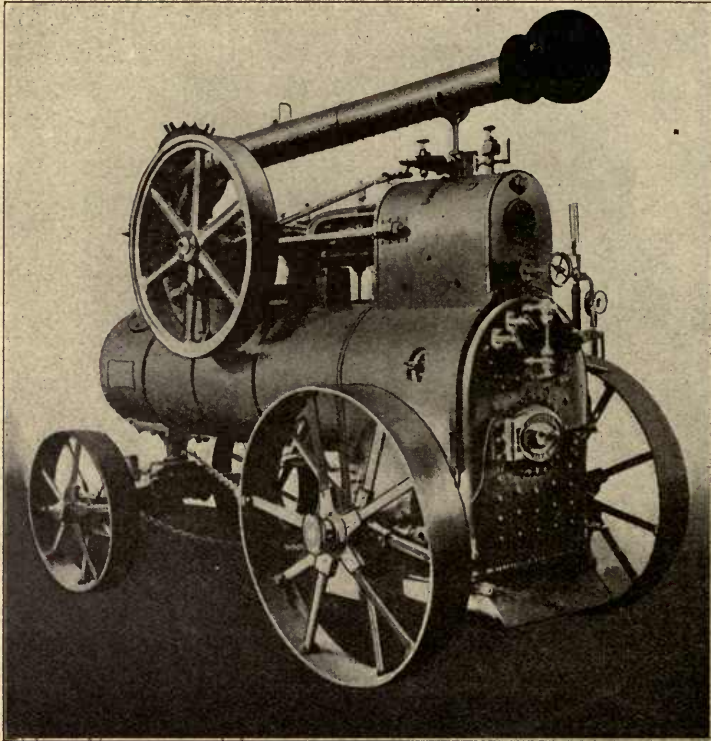


Fig 27.

Ash, clinkers, etc., total . . . . .	kg	46.5
"    "    "    % of coal used . . . . .	%	11.6
Steam pressure, kg/sqcm gage . . . . .		10
Temperature of air at fire door . . . . .	°C	22
"    "    gases in smoke box, mean . . . . .	"	540
Draft in smoke box, mean . . . . .	mm of water	10.2
Evaporation per kg coal . . . . .	kg	3.56
Steam consumption, total . . . . .	"	1424
"    "    per hour, mean . . . . .	"	203.42
Revolutions per minute . . . . .		249.5
Brake load . . . . .	kg	93
Lever arm of brake load . . . . .	mm	560
Indicated HP . . . . .		21.60
Brake HP . . . . .		18.13
Mechanical efficiency . . . . .		0.84
Coal consumption per BHP-hour . . . . .	kg	3.15
Steam    "    "    BHP-    "    . . . . .	"	11.22
Steam    "    "    JHP-    "    . . . . .	"	9.40

The more than ample exhaust port area of this and of other cylinders designed by the author finally led him to the calculation of the exhaust and inlet areas, which was given in chapter I, 3a, in dealing with throttling losses. The great

influence of the back pressure of the exhaust and of the lead on the port area was thus recognized. A non-condensing engine requires a much smaller port area than a condensing engine. In the design of a non-condensing cylinder with an

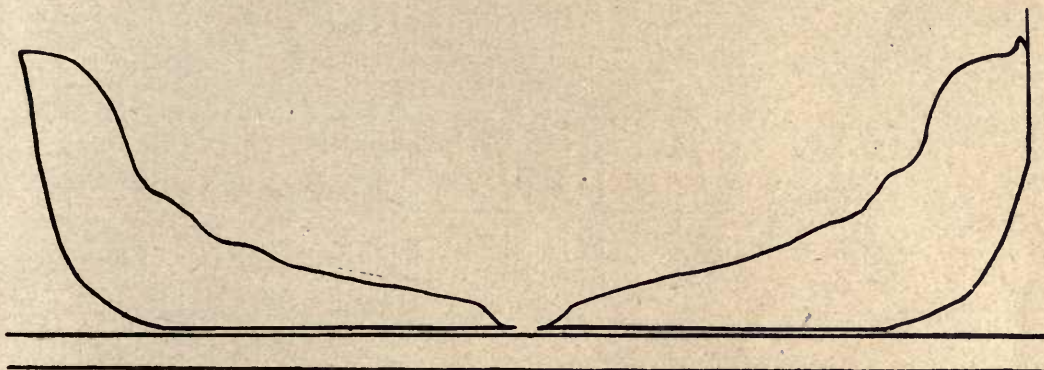


Fig. 28.

exhaust lead of 25 to 30%, the exhaust belt shrinks to two narrow slits formed as nozzles as shown in Fig. 31, to which are connected the two exhaust pipes. These appear surprisingly small, but have sufficient area (Fig. 32). The large exhaust lead gives a shorter length of compression, and therewith a smaller clearance volume, so that the auxiliary exhaust valves of Fig. 29 and 30 may be dispensed with, especially if the parts are so dimensioned that a suction effect with a consequent reduction of back pressure is obtained. The proportions are chosen in such a way that the toe of the diagram becomes rounded off instead of being sharp like that of Fig. 28. The piston and cylinder thus become considerably shorter, and the cylinder is supported on a single foot only. The joint between cylinder and cover is also arranged in a better manner, and the accessibility of the valves is improved by the use of a slipper type of crosshead. A better draft in the firebox is obtained by the expansion and diffusion of the exhaust, and finally all the good constructional features of the engine previously described are retained, especially the valve gear and valve arrangement.

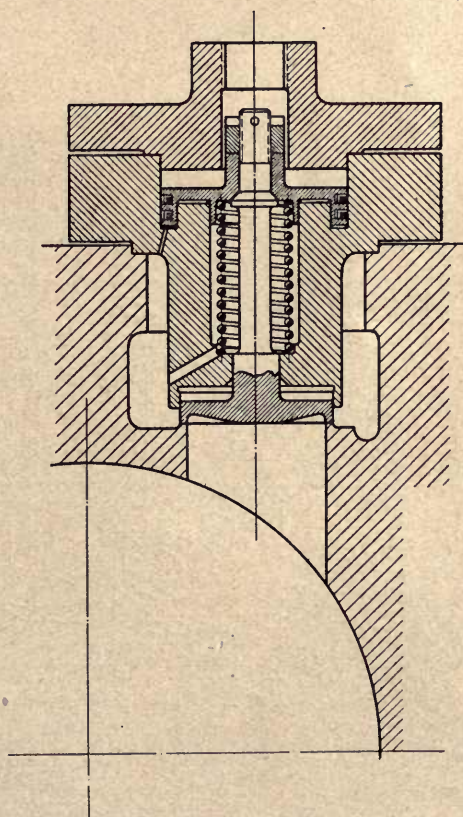


Fig. 29.

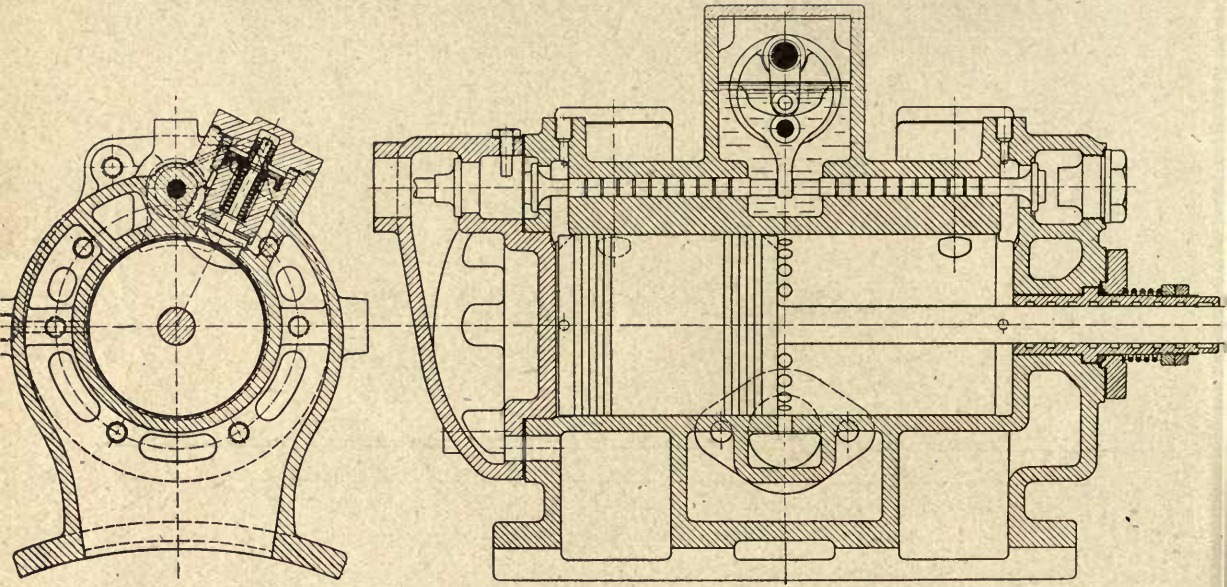


Fig. 30.

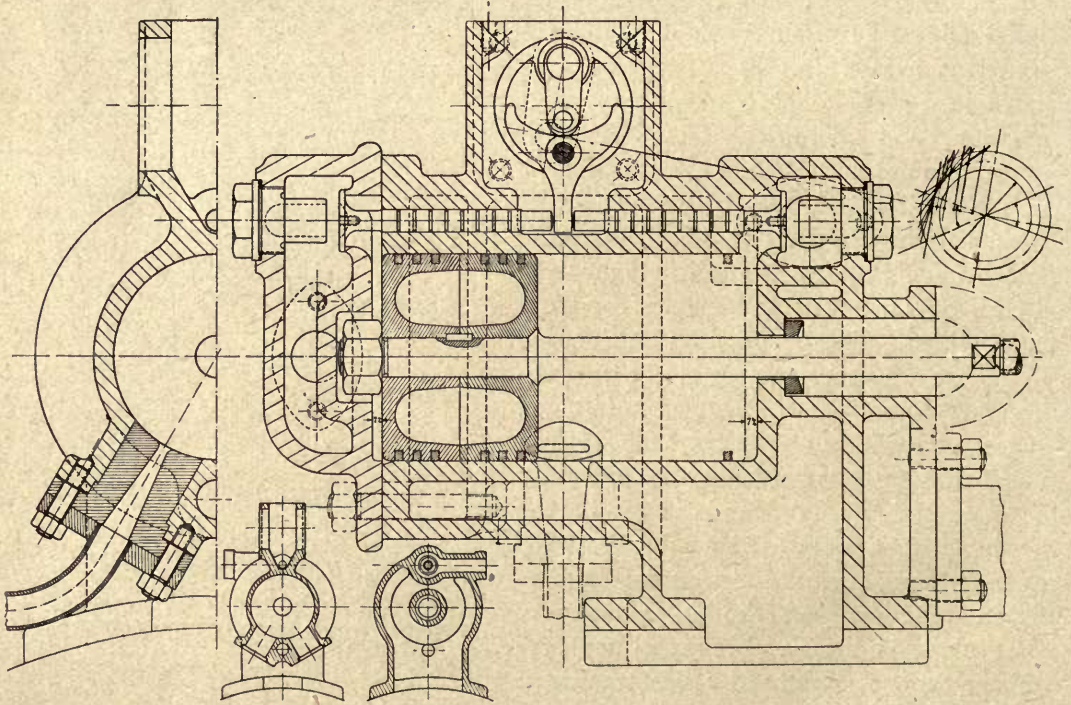


Fig. 31.

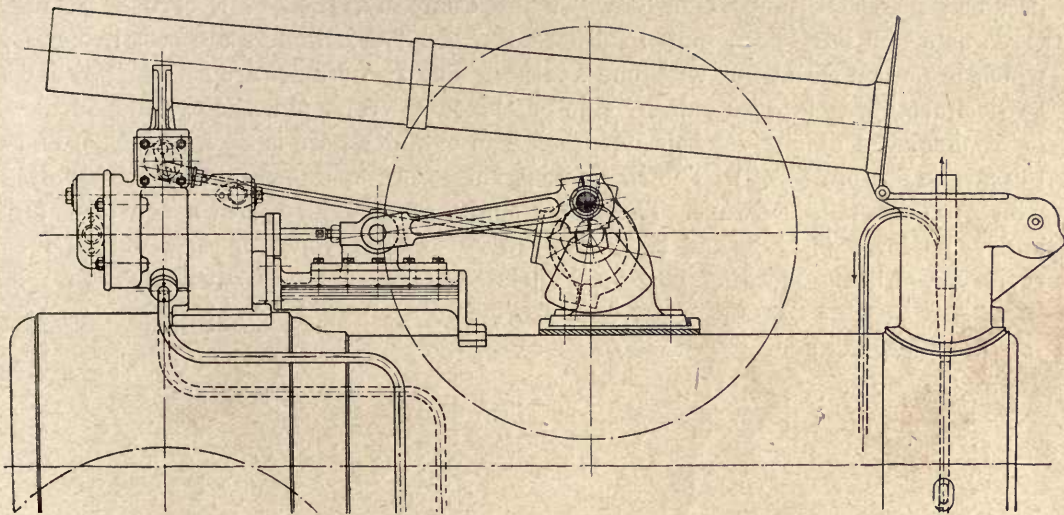


Fig. 32.

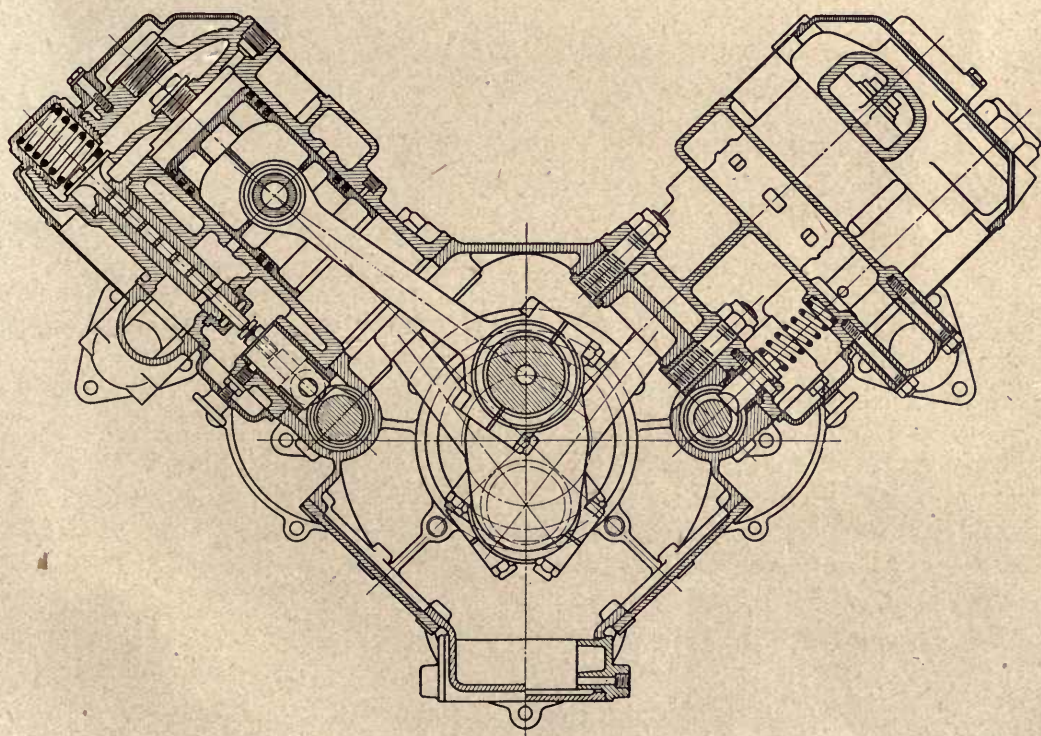


Fig. 33.

Fig. 33 shows a four cylinder V type una-flow engine for automotive purposes designed by the Stumpf Una-Flow Engine Company, Inc., of Syracuse, N. Y., three of which have been built in different sizes. The cylinders are cast in pairs, which are arranged at  $90^{\circ}$  with one another. The two cranks are set at  $180^{\circ}$  and two connecting rods work side by side on the same crank pin, the cylinder blocks being displaced axially for this purpose. The cylinder bore is 85 mm ( $3\frac{3}{8}$ "') and the stroke 95 mm ( $3\frac{3}{4}$ "'). The single-beat valves are operated by two cam shafts which are movable endways. These cam shafts are provided with a neutral cam, and cams for 9%, 25% and 80% forward cut-off, and one for 80% cut-off for reversing. All the working parts are enclosed.



## V. The Una-Flow Marine Engine.

In recent marine practice, serious endeavors have been made to introduce superheating and to employ balanced lift or poppet valves for steam distribution. The una-flow engine is especially adapted to meet this modern tendency, since it is well suited for such conditions. It is also apparent that the advantages which balanced poppet valves have over slide or piston valves are much enhanced when exhaust valves are dispensed with altogether, as is the case with una-flow engines. At the same time this avoids the undesirable complication of the valve gear, which has been the great stumbling block in the introduction of balanced valves in marine engines. The simplification associated with the una-flow engine is of especial advantage when superheated steam is to be used, since it is particularly suited for this. Owing to the unequal distribution of superheat in the case of multi-stage engines, many difficulties have arisen in practice, chiefly in connection with high pressure cylinders. Such troubles are not likely to occur in the una-flow engine, because the superheat benefits the whole working cycle, despite the fact that the latter extends into the saturated region. The increase in reliability consequent thereon is of particular importance from a marine standpoint. In the case of the first few una-flow marine engines which were constructed, the decision to employ this type was governed principally by the fact that the problem of introducing superheated steam into marine practice could be solved in the simplest and surest manner by its adoption.

Since that time, other experiments have shown that the una-flow engine is also well adapted for use with saturated steam, and it should therefore satisfy the natural conservatism of those ship owners and engineers who still regard the introduction of superheating with much scepticism. Such engineers always refer to the absolute necessity of thorough cylinder lubrication which is indispensable with high superheats, and which endangers the safe and efficient operation of the boiler. This is especially the case in multi-stage engines, where the most difficult working conditions occur in the high pressure cylinder, which must be especially well lubricated. On the other hand when saturated steam is employed, cylinder lubrication is commonly dispensed with altogether, or else oil is fed very sparingly and mostly at the beginning and end of a trip. Such a practice would be better justified in a una-flow engine working with saturated steam, where moreover, the balanced inlet valves do not require lubrication.

The first una-flow marine engine, intended for a steam trawler, was built by J. Frerichs & Co., A. G., of Osterholz-Scharmbeck. This engine is of 450 BHP, with two cranks at 90°, so that there is a gain of space for fish storage purposes corresponding to that occupied by one of the cylinders of a triple expansion engine, which had so far been the type usually employed for this purpose. Saeuber-

lich's patent valve gear was used, which gives up to 80% maximum cut-off for maneuvering in addition to ample valve lifts at normal cut-offs. The engine works with highly superheated steam and has satisfied every demand put upon it.

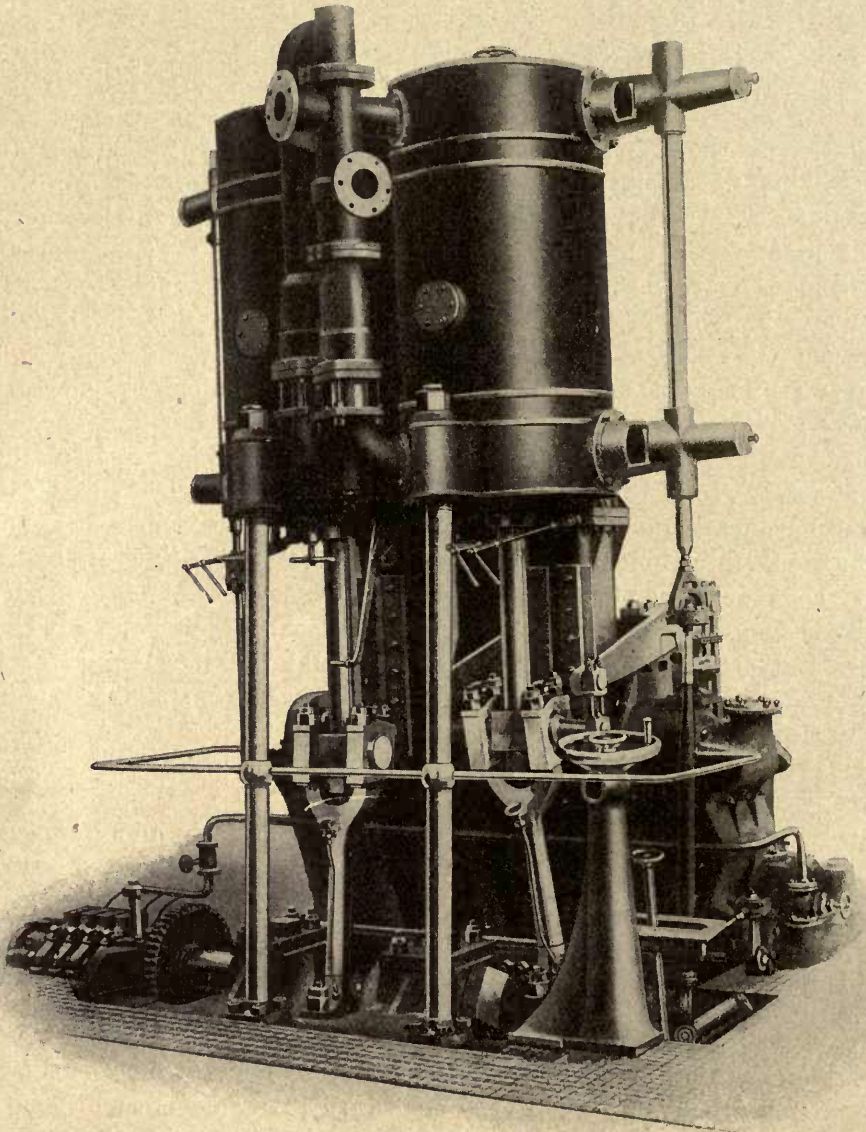


Fig. 1.

The Stettiner Maschinenbau-A.-G. Vulkan, of Stettin-Bredow, next decided to construct a una-flow engine and install it in a steamer of their own build (see Figs. 2 to 4). This engine has two cranks at  $90^\circ$ , and a cylinder bore of 580 mm and a stroke of 600 mm. It develops 400 BHP when using steam of 12 at. gage pressure. The boilers are fitted with superheaters, and a mixing tube is provided so that saturated steam may be mixed with superheated steam so as to obtain

a fairly wide range of working superheats. A Klug type of valve gear is employed, in which the motion of the end of the eccentric rod is communicated to the horizontal valves in the cylinder heads by means of a curved rod and a cam and roller mechanism. The gear was designed for a maximum cut-off of only 26% so as to obtain large opening of the valves at early cut-off. In order to provide for starting and maneuvering, an auxiliary piston valve giving a maximum cut-off of 90%

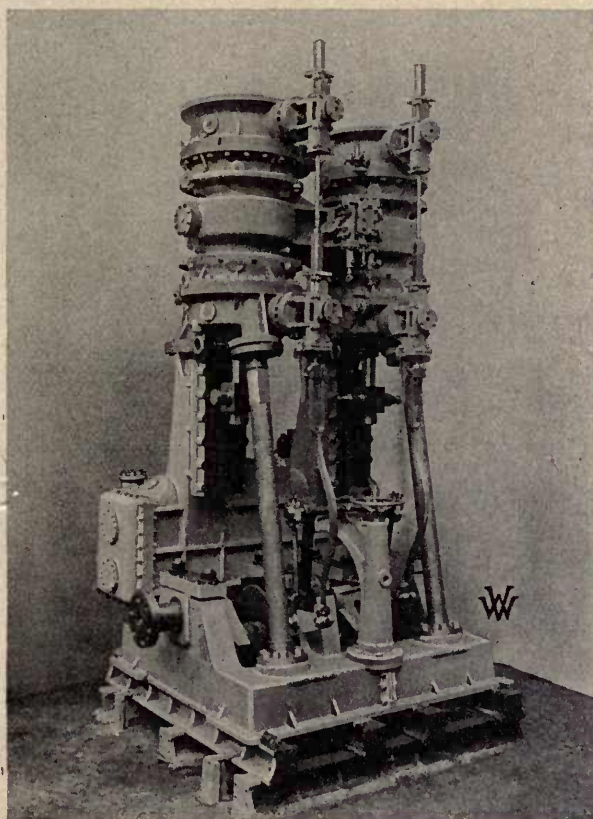


Fig. 2.

is mounted on the exhaust belt, and is operated from a second pin, which in this particular case coincides with the point of suspension of the arm of the eccentric. This valve at the same time controls a set of auxiliary exhaust ports to permit of relieving the compression when starting up with no vacuum in the condenser, since the air pump is directly driven from the engine. This type of auxiliary valve gear is shown diagrammatically in Fig. 5, which represents the arrangement employed on a una-flow marine engine installed in the steamship "Strassburg" owned by the Hamburg-American Line. It should be noted that the pilot valve which admits live steam to the auxiliary piston valve, as well as the cylinder valves which control the connections from the latter to the ends of the working cylinder, are actuated automatically by the valve gear, so that no extra manual operation is required for maneuvering. When the gear is in either of its outermost positions

for ahead or astern running, the pilot valve and cylinder valves are opened, while in intermediate positions of the gear all these valves are closed. When maneuvering, it is only necessary to turn the reversing wheel until the engine responds. If the main gear does not start the engine, then the auxiliary gear will come into action. As soon as the engine begins to turn over, the gear is brought back to the normal running cut-off of 10%. In this position the auxiliary valve gear is completely cut out. The elimination of hand-operated valves thus greatly simplifies maneuvering.

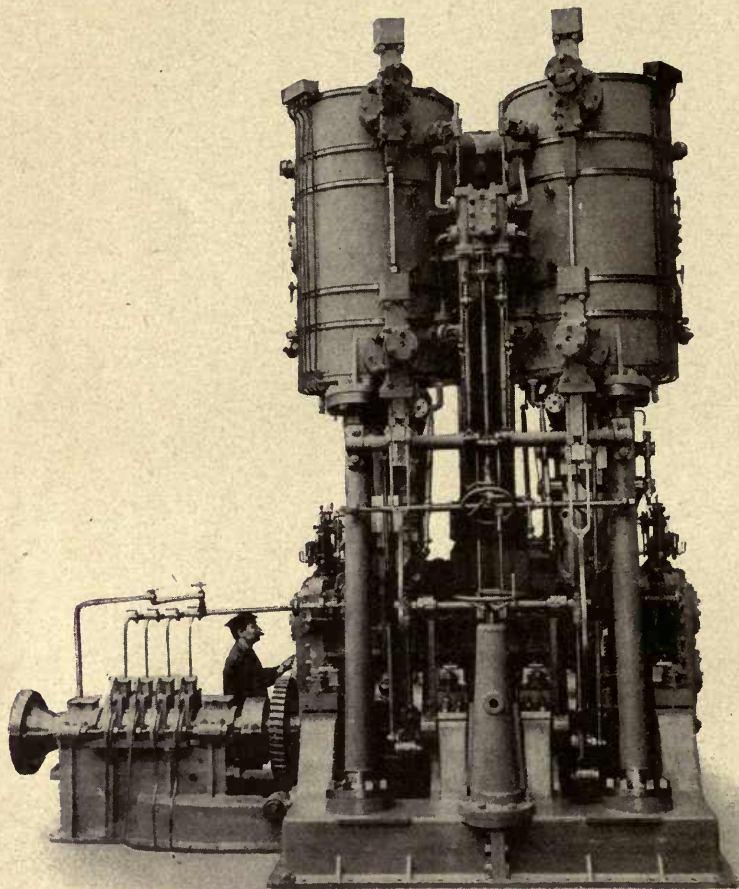


Fig. 3.

The air pump and auxiliaries are directly driven from the main engine, and it is for this reason that the auxiliary piston valve is also arranged to relieve the compression when starting and maneuvering.

The condenser is incorporated in the rear columns in the customary manner. The entire valve gear is mounted at the front of the engine where all parts are accessible. As shown in Fig. 6 the crank cheeks are formed as eccentrics. The engine is designed to work ordinarily with superheated steam of a temperature of only 250° C and the ends of the cylinder barrels are therefore steam jacketed, in addi-

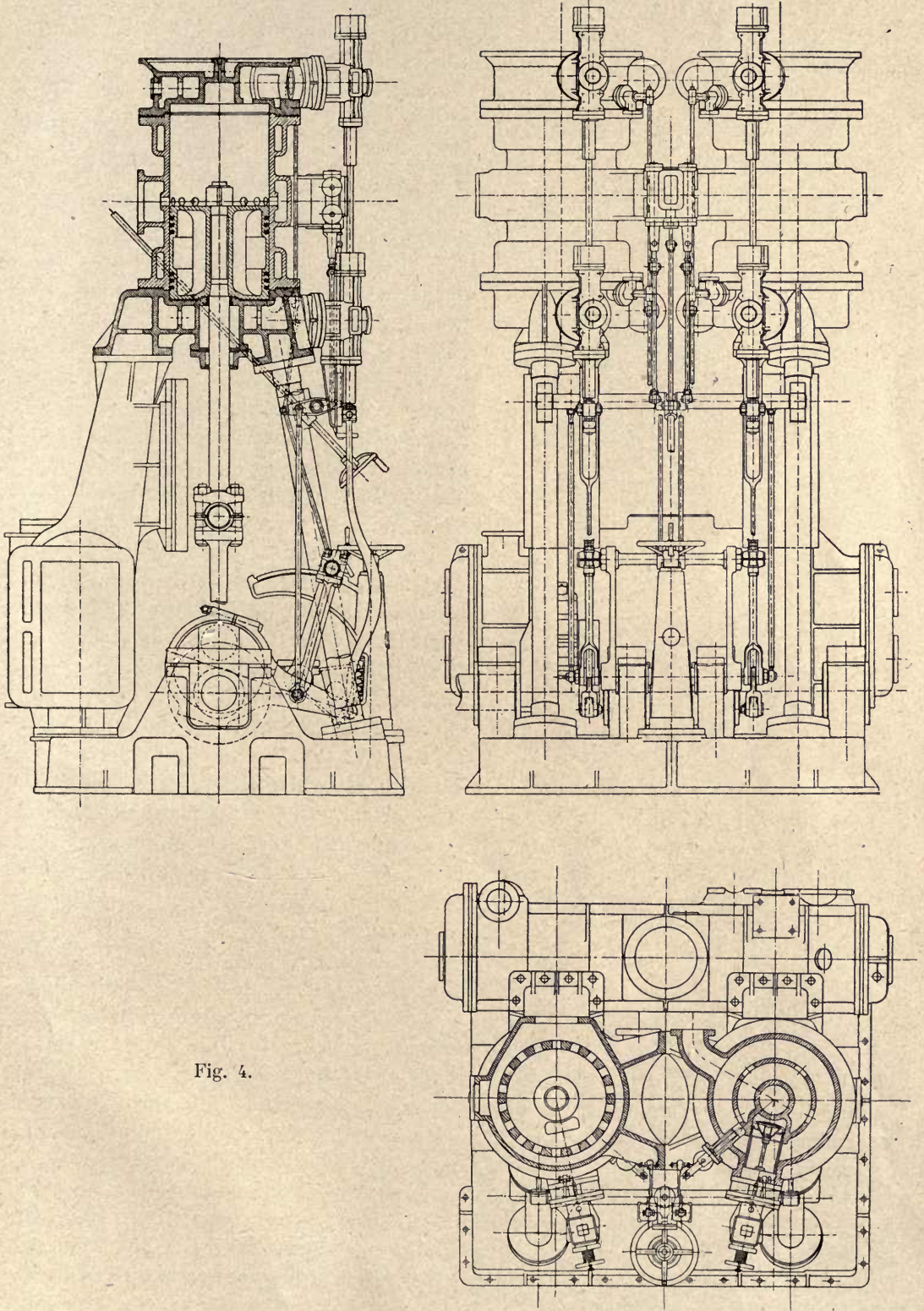


Fig. 4.

tion to the heads. The cylinders are bolted together along their exhaust belts, where the temperature is lowest; the rigidity of the whole structure is therefore considerably increased without appreciable changes of alignment due to expansion.

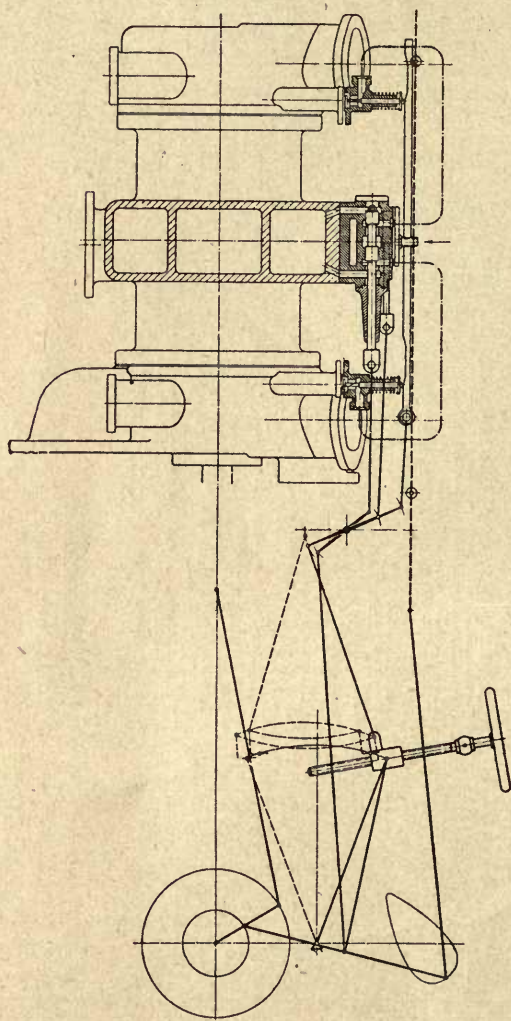


Fig. 5.

ship Co., of Copenhagen. Each engine is of 1000 BHP and has three cylinders. The Klug type of valve gear is employed, but the auxiliary mechanism is omitted since with three cranks at  $120^\circ$  the maximum cut-off necessary for maneuvering is only about 40%. With this longest cut-off the inlet valves still give sufficient opening at the normal cut-off of 10%. Each cylinder has independent steam and condenser connections, and it thus becomes possible to cut out any one in case of need. By using a longer cut-off in the two remaining cylinders, the full running power may then be obtained.

Fig. 7 shows the steam valve together with its valve bonnet and cam mechanism. In Fig. 8 is shown an outline view of the cargo steamer "Vulkan", which was fitted with the engine just described.

The Hamburg-American Line also decided to fit two una-flow engines to the twin-screw steamer "Strassburg", which plies between Hamburg and Cologne. This boat, shown in Fig. 9, was built in the yards of Gebrüder Sachsenberg A.-G., of Deutz near Cologne. Each propeller shaft is driven by a two-cylinder vertical una-flow engine, the cylinders of which have a bore of 440 mm and a stroke of 450 mm. Each engine develops 250 IHP at 175 r. p. m. when using steam of 12 at. pressure, at a temperature of  $325^\circ$  C. As will be seen from the photograph reproduced in Fig. 10, and from the drawings given in Fig. 11, these engines are built on the same lines as the "Vulkan" engine just described. They are likewise fitted with the Klug type of valve gear with auxiliary gear as described above. On account of the high degree of superheat, the steam jackets on the ends of the cylinder barrel were omitted.

The firm of Burmeister & Wain, of Copenhagen, also decided to introduce the una-flow engine on two single-screw steamers ordered by the United Steam-

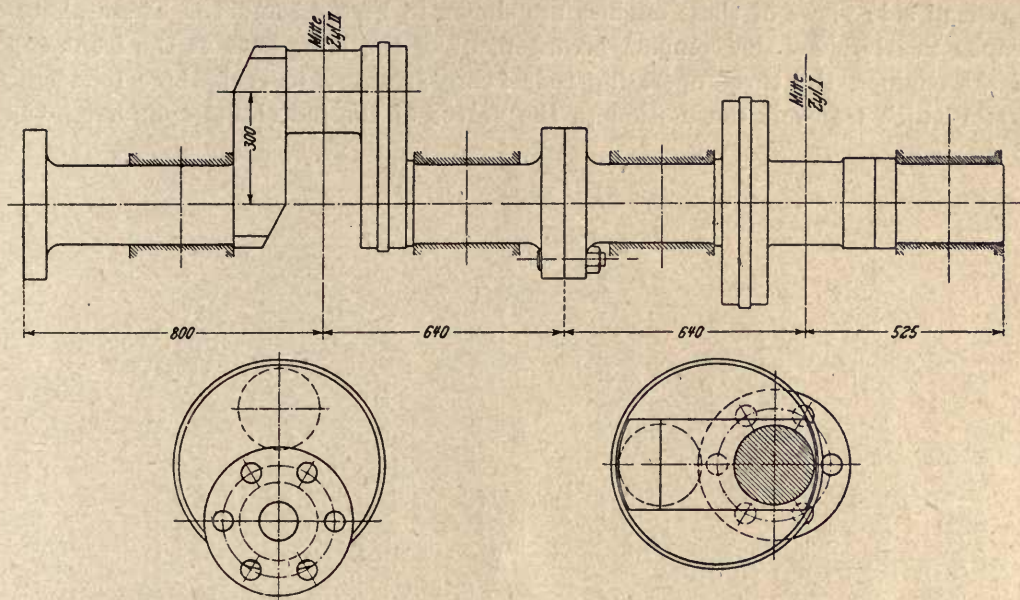


Fig. 6.

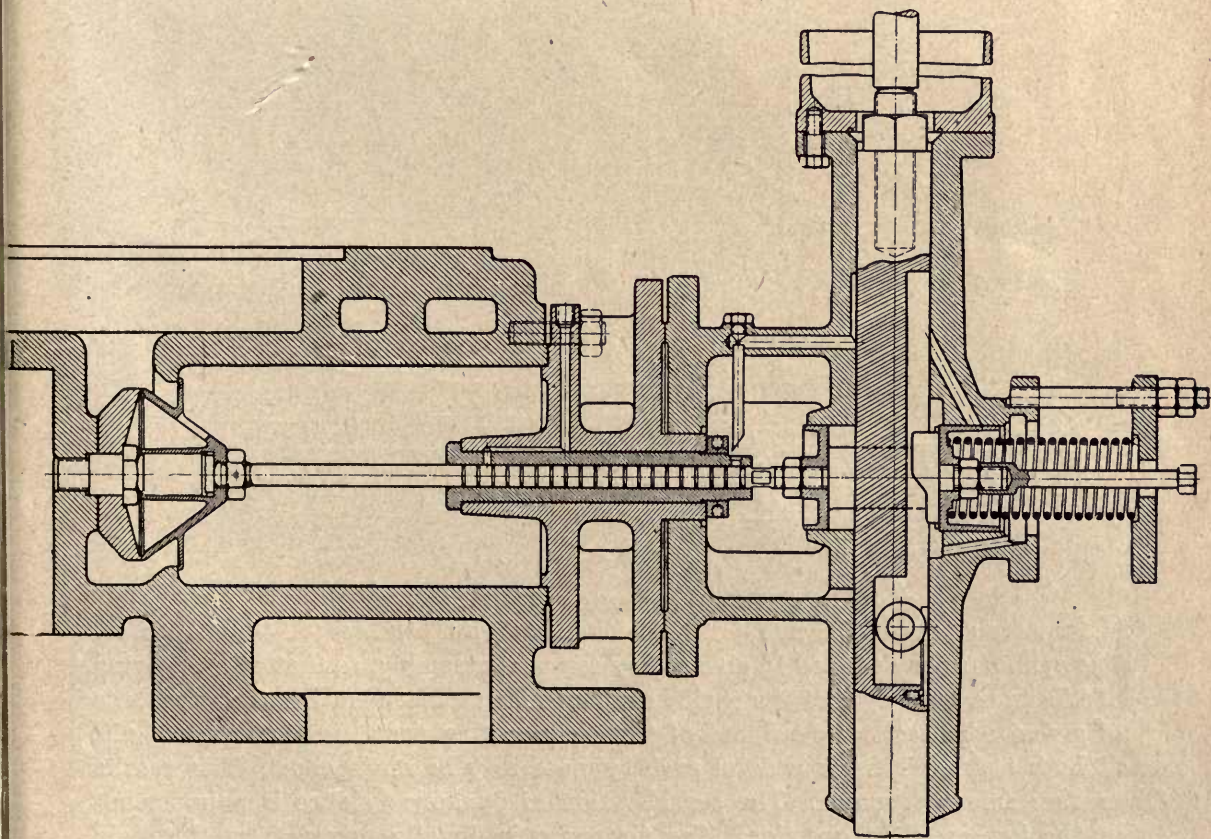


Fig. 7.

Half side views of these engines are shown in Figs. 12 and 13. These photographs clearly show the compact arrangement of the Klug gear at the front end of the engines, the three operating rods being arranged to rock three telescopic shafts which transmit the motion to the valves of the individual cylinders. The

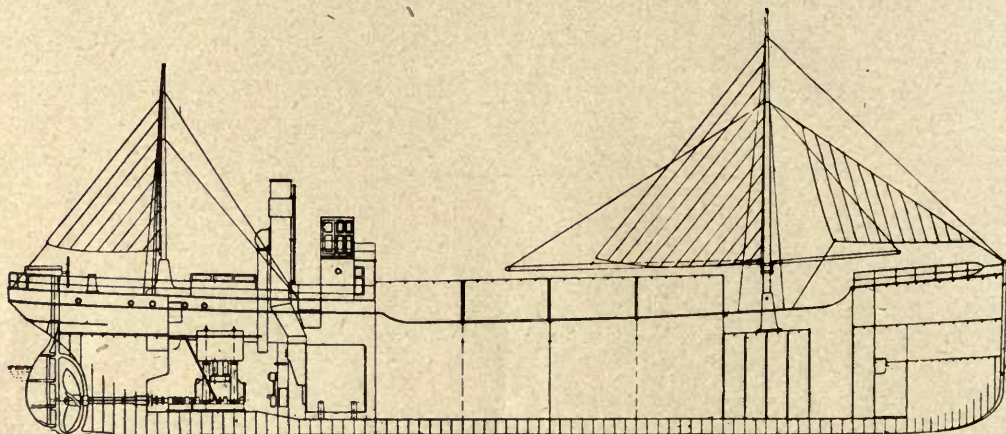


Fig. 8.

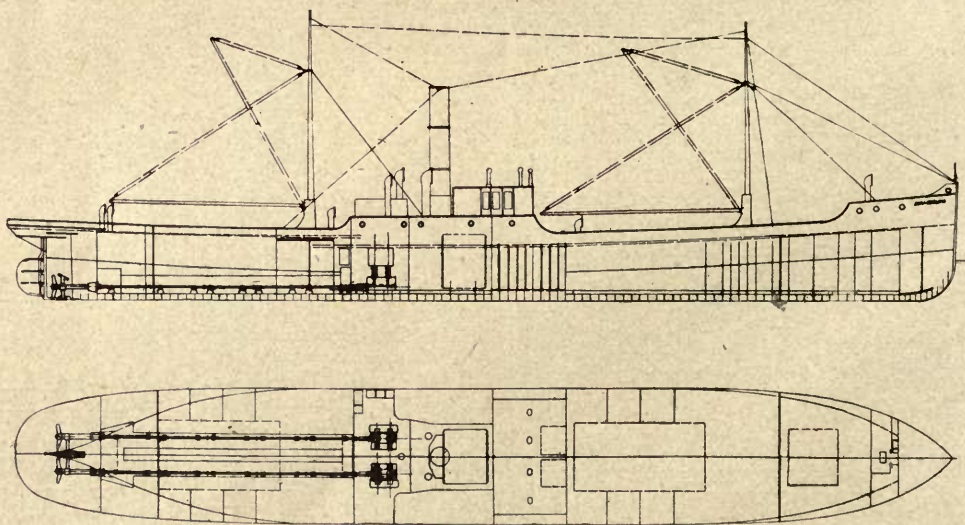


Fig. 9.

latter have a bore of 635 mm, with a stroke of 915 mm, the speed being 84 r p. m. The cylinders are designed to give a very compact assembly, so that a total saving of 1.75 m in the length of the engine results. This arrangement has the advantage of giving a better static balance of the reciprocating parts, so that the cut-offs at both head and crank ends of each cylinder may be made equal. This results in very smooth running. The consideration of dynamic balance is unimportant at the low speed in question. The air pump is directly driven from the main engine, and a small auxiliary pump is provided for creating a vacuum before starting



the engine. This may also be accomplished by using an ejector or by opening the blow-off cocks.

All the cylinders are provided with bleeder valves, the steam withdrawn being used for heating the feed water.

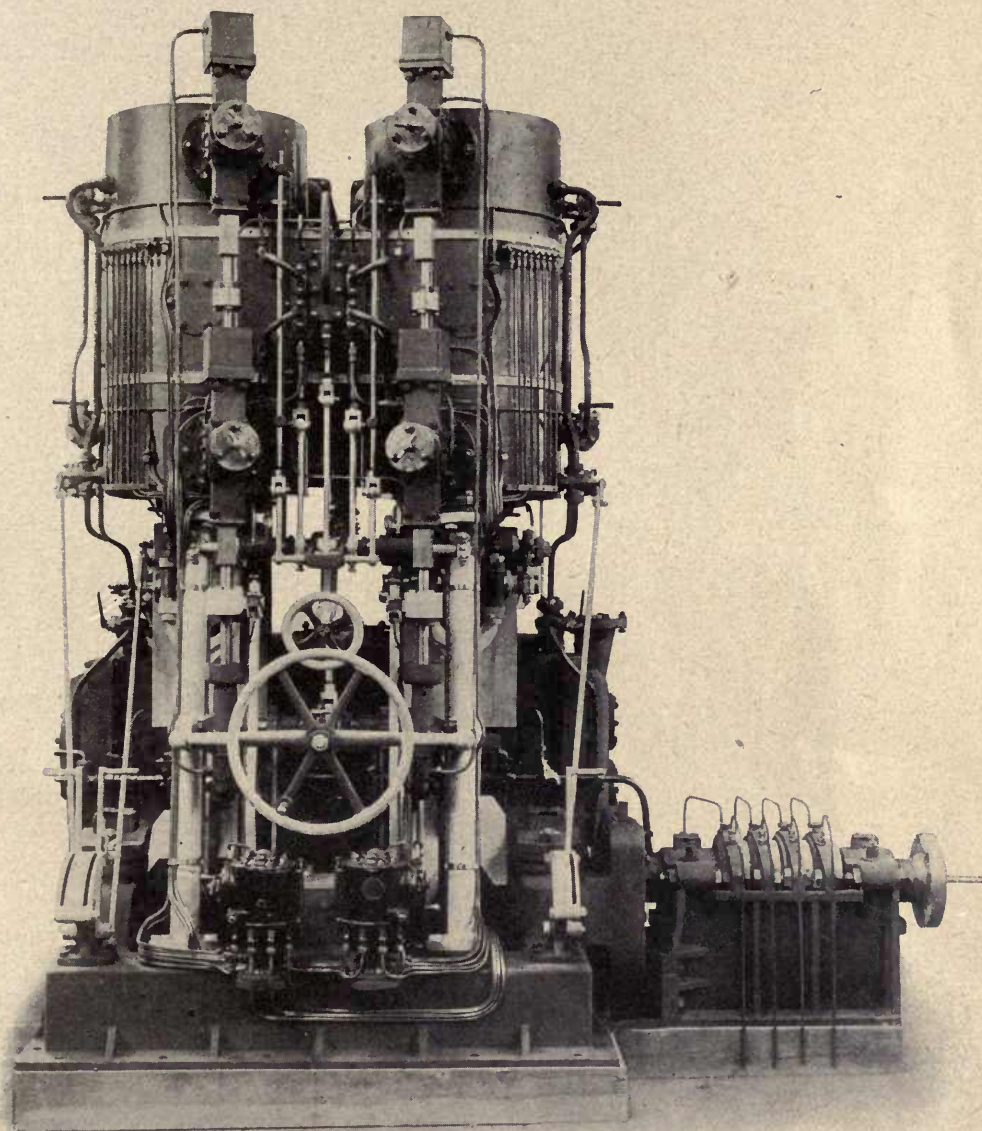


Fig. 10.

The connection between the exhaust belts of the cylinders and the condenser is especially worthy of notice. Each cylinder has an individual connection, but since the exhaust belts are all interconnected, there is always ample area of passage from each cylinder to the condenser.

Despite the high superheat used, there is no special provision for cylinder lubrication. This is due to the fact that with single-stage expansion, even with high superheats, the cycle extends into the saturated region, so that the average temperature of the working surfaces is low. The cylinders are lubricated sparingly only at the beginning and end of a trip, while in ordinary running they are not

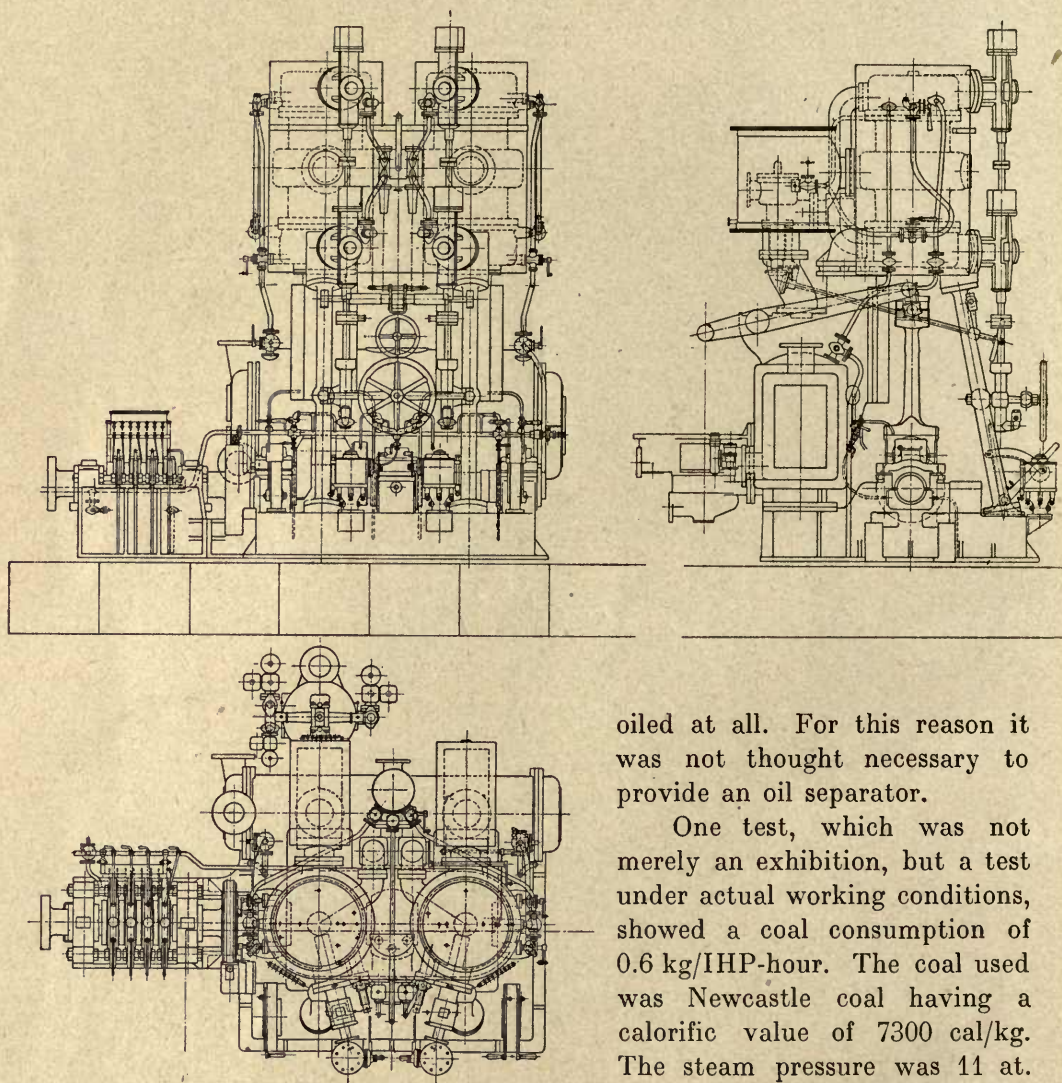


Fig. 11.

oiled at all. For this reason it was not thought necessary to provide an oil separator. One test, which was not merely an exhibition, but a test under actual working conditions, showed a coal consumption of 0.6 kg/IHP-hour. The coal used was Newcastle coal having a calorific value of 7300 cal/kg. The steam pressure was 11 at. and the temperature 220° C. The steam used by the auxiliary machinery was included in figuring the above result. It should be noted that no forced draft or means of preheating the air is provided, and that the ends of the cylinder barrels are not jacketed. The boilers are fitted with Jörgensen patent superheaters which have proved very reliable in service.

The steamer proved most satisfactory to both the purchasers and builders, and it was a pleasant surprise to both parties to find that the guaranteed speed

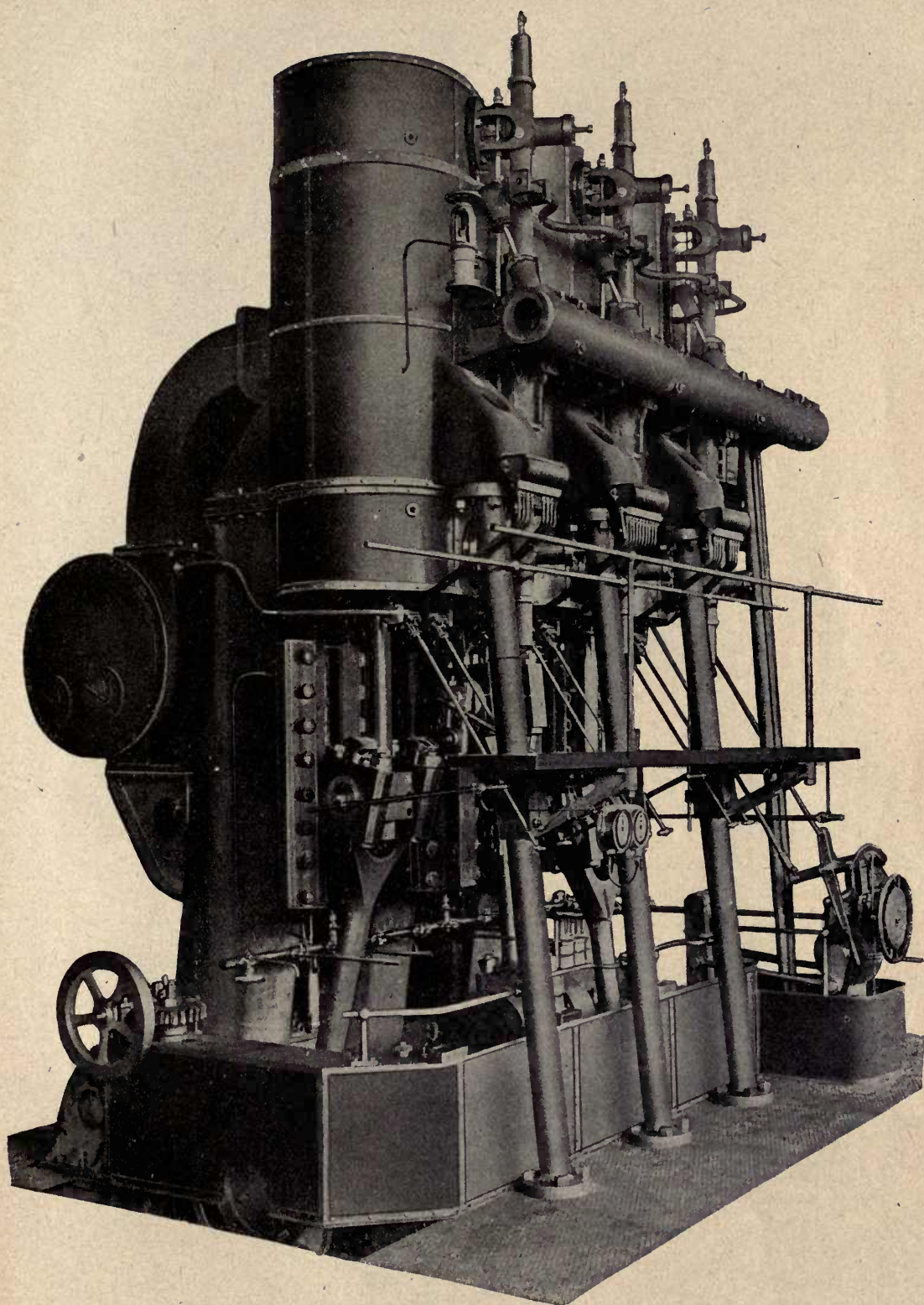


Fig. 12.

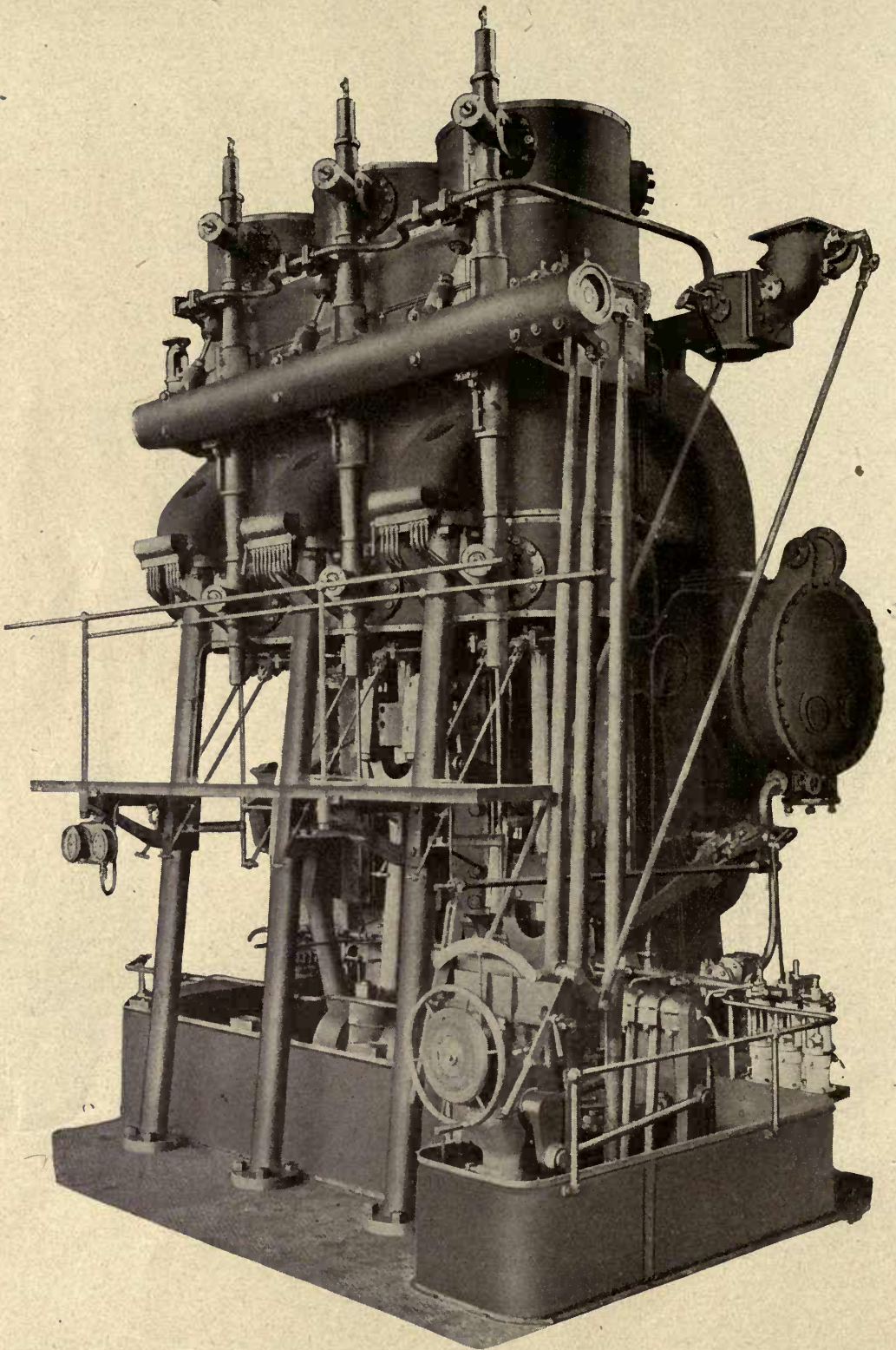


Fig. 13.

was obtained with 800 HP instead of 1000 HP as mentioned in the specification. The excellent indicator cards taken during the trial trip are shown in Fig. 14.

Fig. 15 shows a design of a una-flow marine engine embodying a Walschaert valve gear, which has been so successful on locomotives.

In Fig. 16 is shown the assembly of the compound engine of the steamer "Wera", owned by the Orient Co., of Petrograd. On account of the excellent steam consumption results obtainable with the una-flow engine, this company decided to replace the compound engine by a two cylinder una-flow machine having a cylinder bore of 600 mm and a stroke of 711 mm. Superheating had been tried experimentally on this ship, but the old engine had proved unsuitable for use with it. For this reason it was decided to change over to una-flow cylinders, the design being shown in Figs. 17 and 18. The steamer is fitted with two engines, each of which is capable of developing 500 HP at a maximum speed of 125 r. p. m. The ends of the cylinder barrels are steam jacketed, so that the engine is suitable for working with saturated steam if the occasion should arise.

In marine practice there is also need for a valve gear which will give proper valve lifts for normal cut-offs without having excessive movement for cut-offs of 70 to 80%. From this point of view was developed the valve gear shown in Fig. 19.

In all the common valve and reversing gears the angle of advance as well as the throw of the resultant eccentric are varied, with the effect that for small cut-offs the throw of the eccentric is also small, as is the valve opening. All parts of the engine, however, have to be proportioned to accommodate the maximum eccentric throw. Obviously, the valve opening for small cut-offs could be materially improved if instead of changing the eccentricity and angle of advance, the former is kept constant and only the latter is changed. This method of course necessitates a change of the lap lines as is shown in Fig. 22, in which the left hand diagram is drawn for valve gears of the Klug or Walschaert type while the right hand diagram is for a gear incorporating this new principle. The right hand diagram is drawn so that the constant throw of the eccentric is equal to the maximum throw in the case of the left hand diagram. The valve opening "A" for maximum cut-off is equal in the two cases. For normal cut-off, however, the valve opening "B" of the new type of valve gear is seen to be considerably larger than that given by the standard valve gears.

In the design shown in Fig. 19, a bevel gear is keyed to the end of the crank shaft and meshes with a pinion mounted in a rotatable housing, which in turn drives another bevel gear similar to the first, but in the opposite direction. The latter is keyed to a sleeve together with four eccentrics, each of which operates one of the valves of the two cylinders. These eccentrics are connected to rocking levers mounted on an eccentric spindle which is geared to, and is turned simultaneously with the gear housing. This gear housing is turned by means of the reversing wheel, and in order to turn the eccentrics and the eccentric rocker spindle through the same angle, the gear ratio, on account of the differential action, must be two to one. The main eccentrics as well as the eccentric rocker spindle are moved in the same direction and in such a relationship that with one of the cranks in its dead center the corresponding cam roller remains stationary, thereby keeping

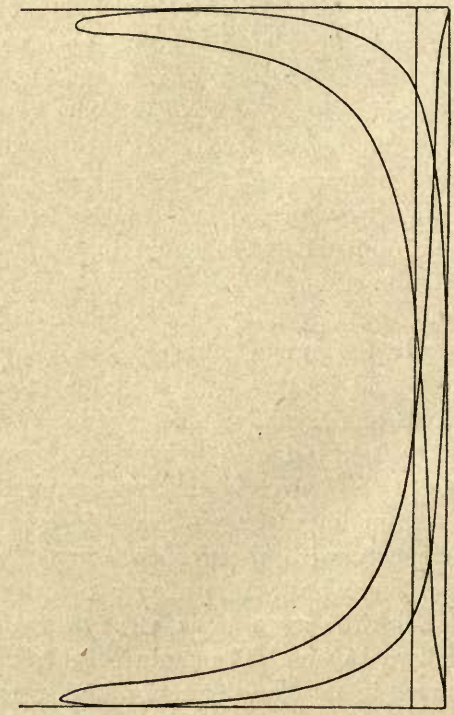
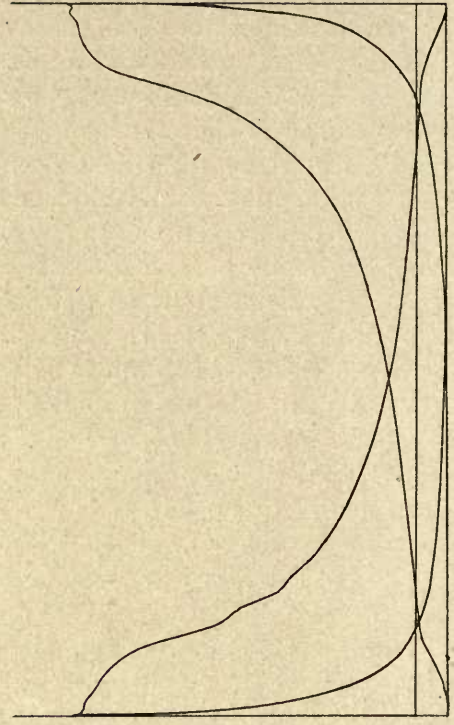
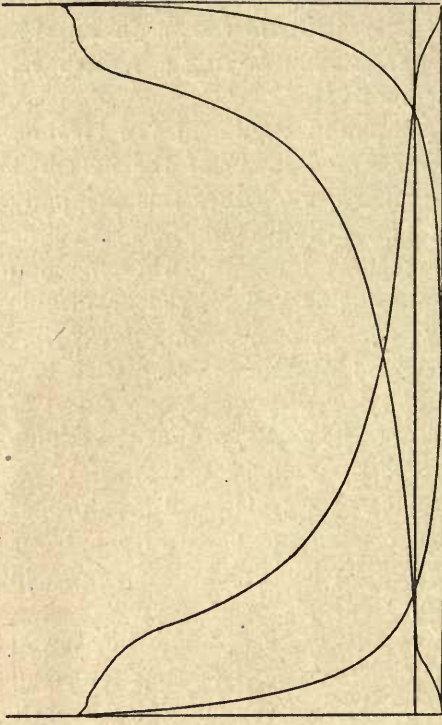


Fig. 14.

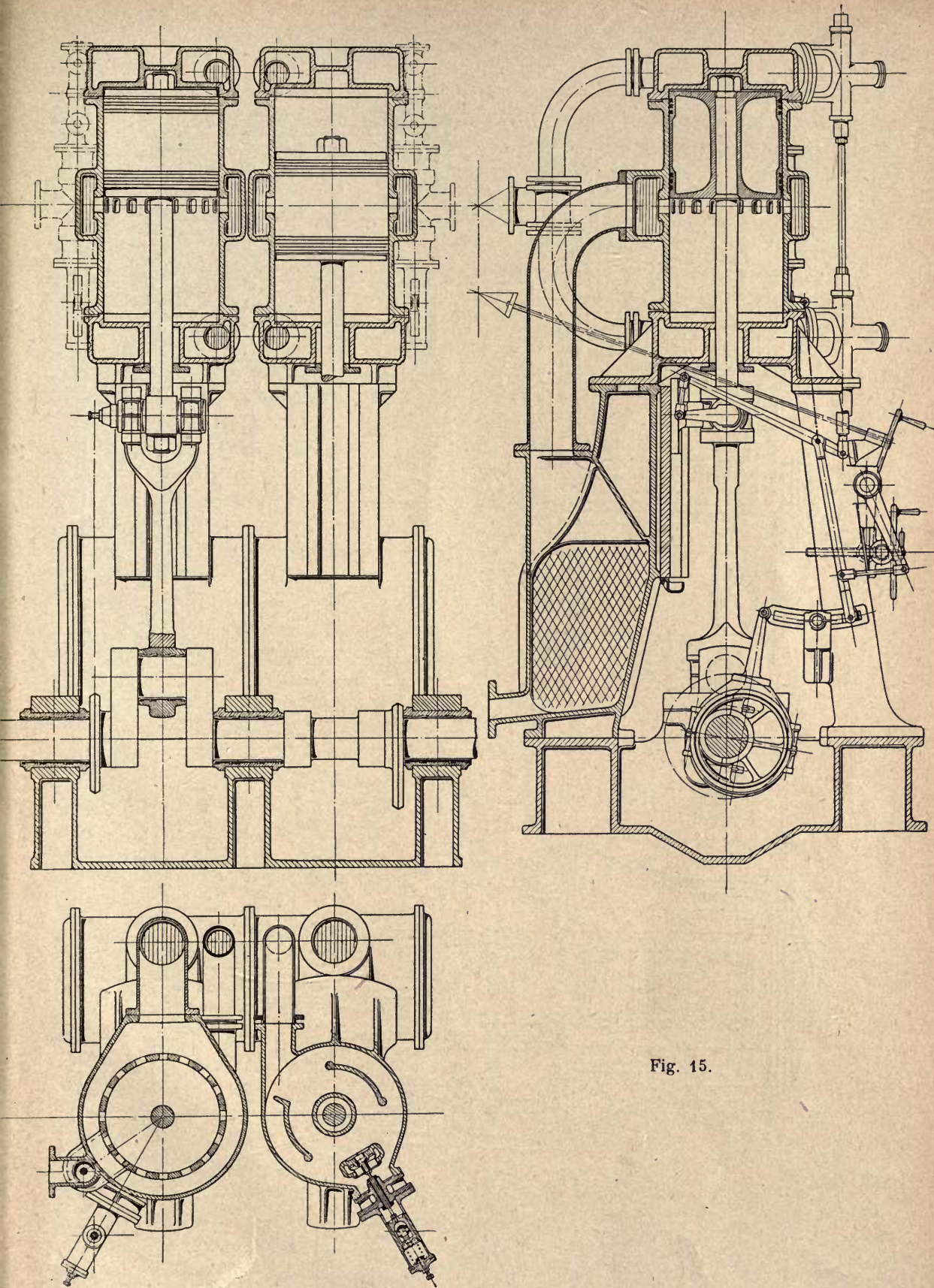


Fig. 15.

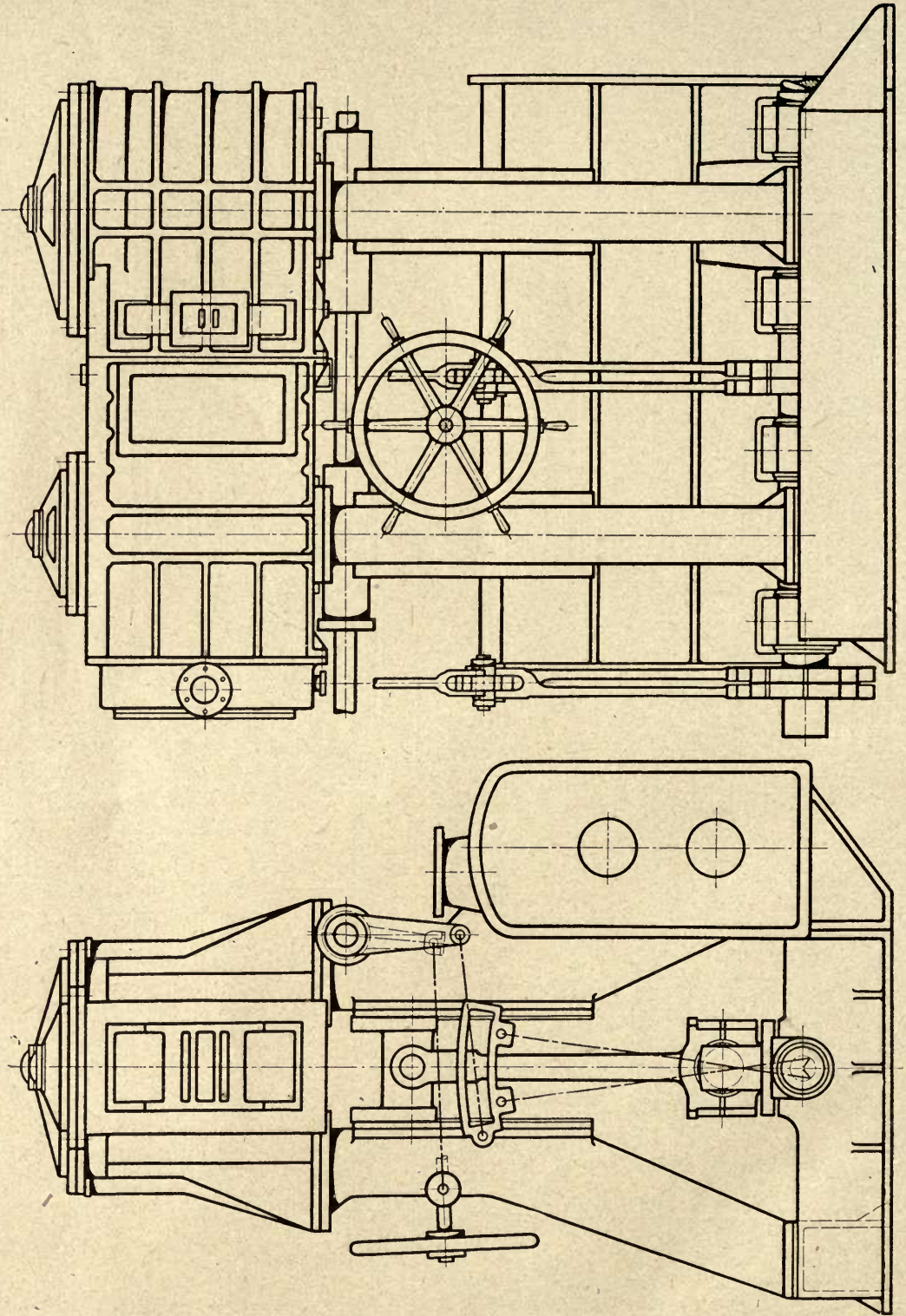


Fig. 16.



the point of opening constant. When the main eccentrics are thrown from full ahead to full astern, the eccentric rocker spindle is moved through the same angle. The resultant eccentric curve for this gear is therefore not a straight line but a circle drawn about the center of the shaft. The throw of the eccentric is always the same and the lap is altered in proportion to the angle of advance. When the arms of the rocking levers have the ratio 1 : 1, the eccentricity of the spindle must be one-half that of the main eccentrics. The eccentric rods are very short in order to compensate for the angularity of the connecting rods. In addition, the rocking levers are proportioned to give a later cut-off at the crank ends of the cylinders and an earlier cut-off at the head ends for forward running, so as to eliminate the effect of the weight of the reciprocating parts.

The motion of the valves is derived from that of the rocking levers by means of reach rods and cam and roller mechanisms. The rollers of the head and crank end bonnets are arranged above the cams, and the eccentrics are set so that the rocking levers for the same cylinder move in opposite directions.

An interesting modification of this gear is shown in Fig. 20. In this case the eccentrics operate the four valves of the two cylinders through telescopic shafts. The latter are mounted on a long spindle mounted eccentrically in two bearings arranged on the exhaust belt. This spindle and the bevel gear housing are interconnected by a vertical spindle and two worm gears in such a manner that the

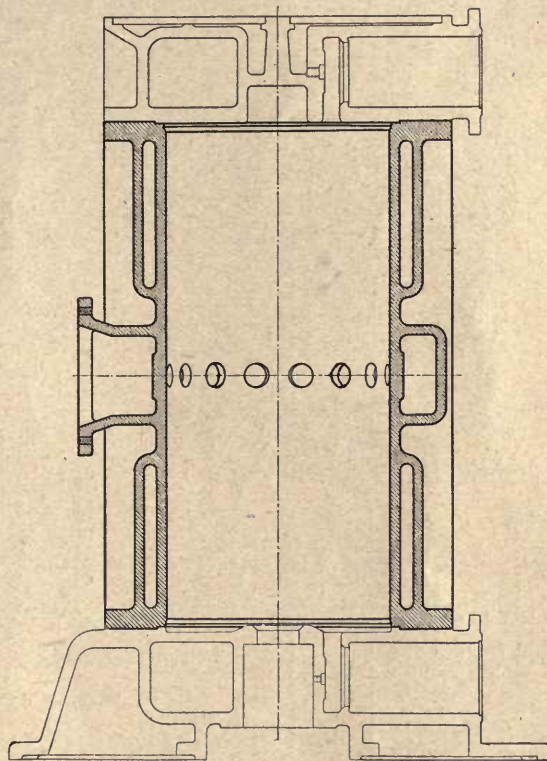


Fig. 17.

center of the telescopic shafts is swung through the same angle as the main eccentrics. When the latter are moved from the full ahead to the full astern position, the center of the telescopic shafts is displaced by the same angle. The throw of the main eccentrics and the eccentricity of the spindle carrying the telescopic shafts are so proportioned that the lap of the inlet valves is changed in conformity with the alteration in the angle of advance of the eccentrics. In this case, as in the other form of this valve gear described above, no auxiliary gear is required, since cut-offs up to 85% are easily obtainable. A diagrammatic outline of this gear is shown in Fig. 21.

In Fig. 23 are shown a side elevation and plan of a una-flow marine engine for a paddle steamer plying on the river Volga in Russia. This engine has a cylinder bore of 600 mm, a stroke of 800 mm and develops 180 BHP at 26 r. p. m.

Details of the cylinders and heads are given in Figs. 24 and 25.

The crank end cylinder heads are tied to the main bearings by cast steel rods of square section which also serve as crosshead guides. The main bearing housings are cast in one piece with their supports. The valve gear is arranged at one side of the engine and consists of two sets of Klug type reversing motions which operate the valve cam mechanisms through the medium of a pair of telescopic shafts mounted transversely on the exhaust belts. The arms of the eccentric straps extend downwards and are connected at intermediate points by links to a yoke piece which may be adjusted by hand through screw gearing. The main valve gears are designed for a maximum cut-off of 25%, the head and crank end

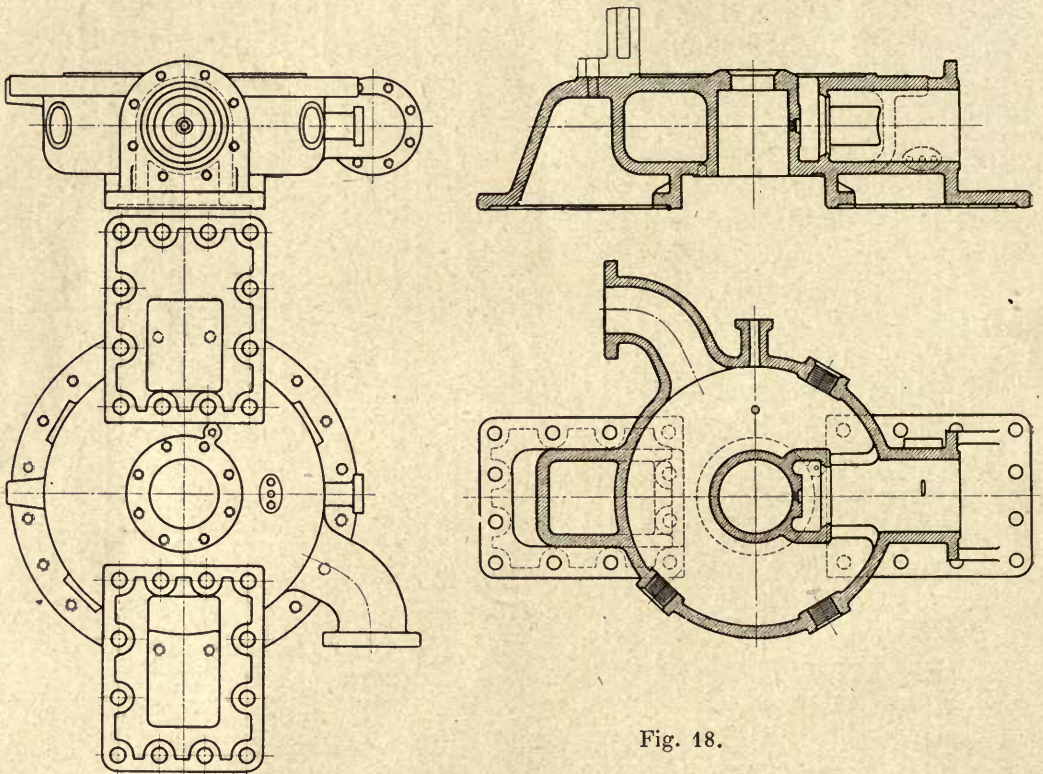


Fig. 18.

cut-offs being equalized as far as possible. An auxiliary valve gear is driven from a pin on each of the short eccentric arms, which in this case coincides with the point of attachment of the swinging link. This auxiliary gear gives a cut-off up to 90% of the stroke, and thereby permits of easy maneuvering. The auxiliary valves are operated by means of a cross shaft and rocking levers supported at the crank end of the cylinders. The auxiliary gear is cut out by a suitable mechanism actuated by a sleeve mounted on the cross shaft, this mechanism being connected to the main valve gear yoke in such a manner that the entire control during maneuvering is effected from the main gear.

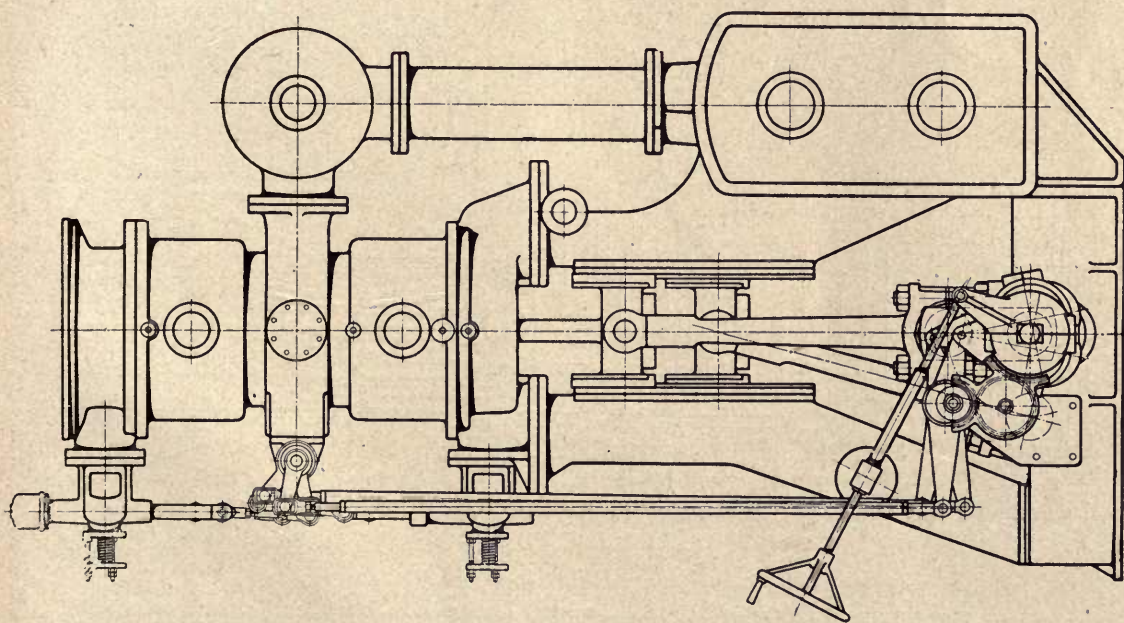
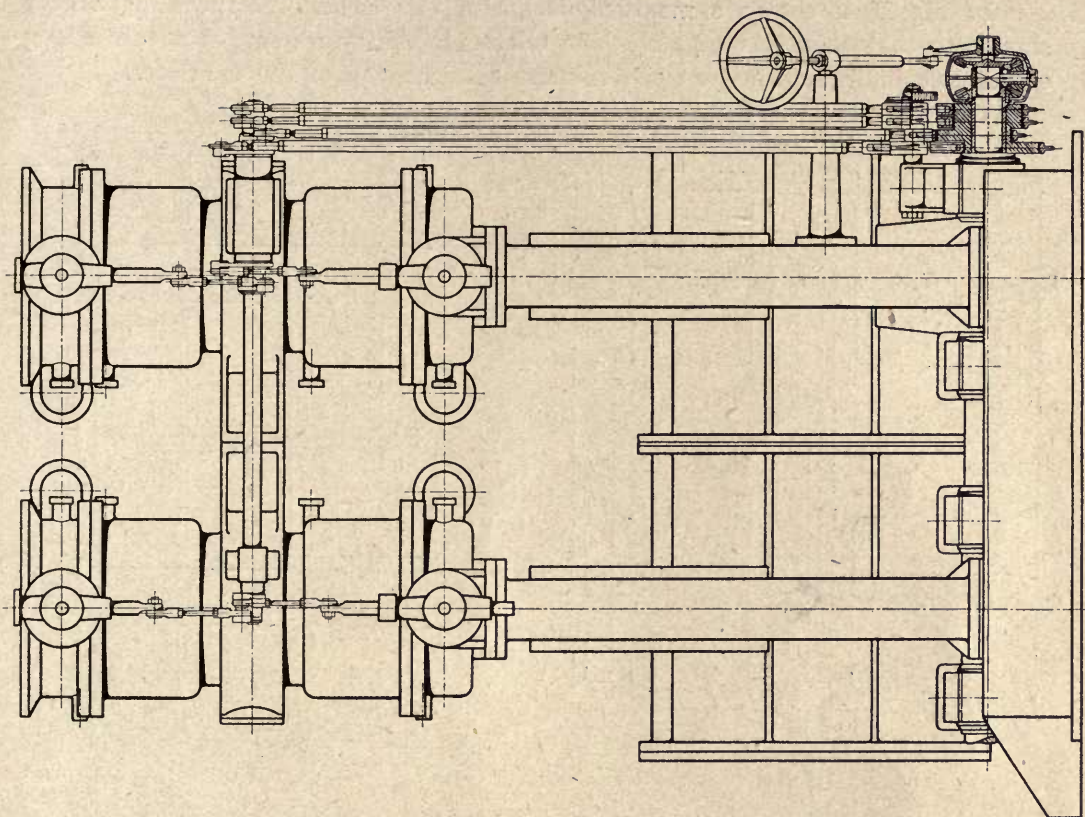


Fig. 19.

In Fig. 26 is shown a modified design of this engine incorporating a gear similar to that shown in Fig. 20. The telescopic shafts are supported on a long eccentric spindle arranged on the exhaust belts on top of the cylinders.

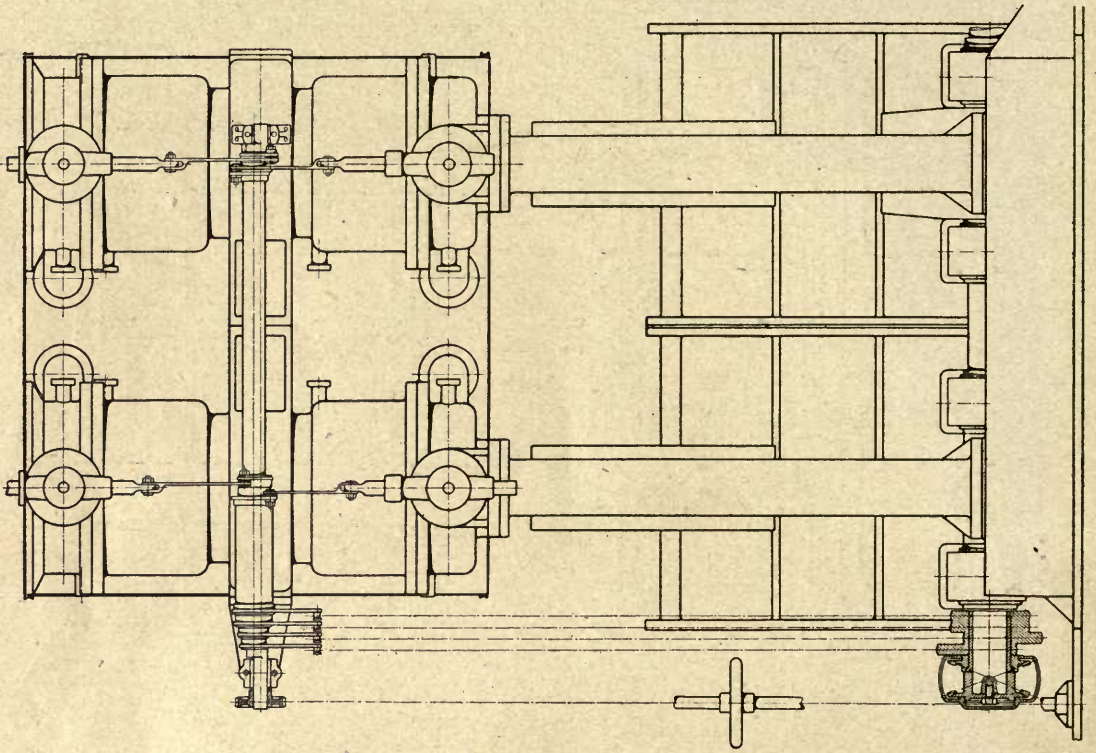
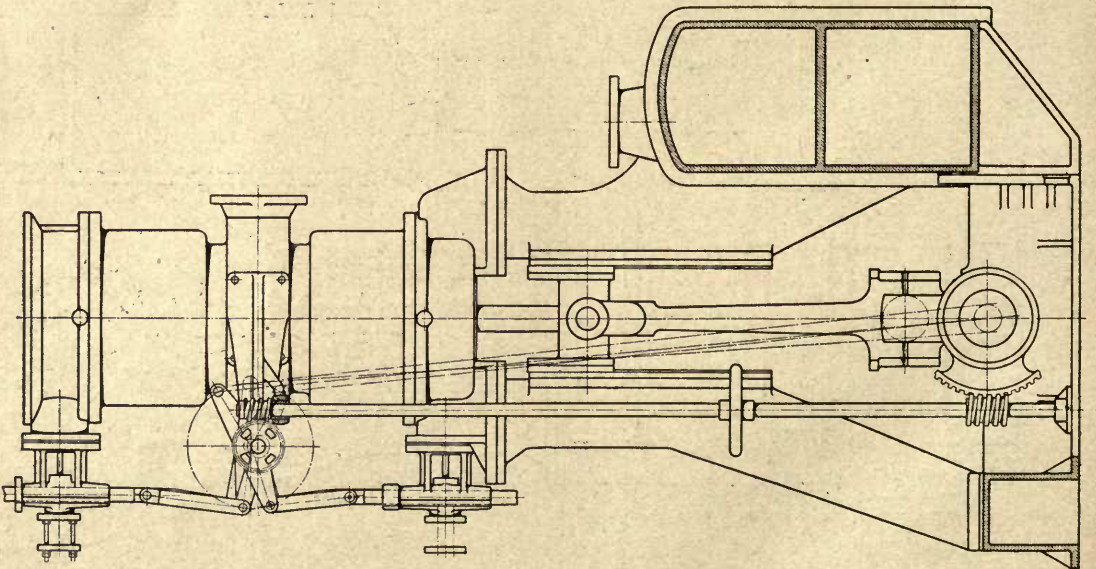


Fig. 20



In Fig. 27 is illustrated a two-cylinder una-flow marine engine built by the Kingsford Foundry & Machine Works, of Oswego, N. Y. This engine is fitted to

a tug boat working on the New York State barge canal, and has a cylinder bore of 18" with a stroke of 18". The valve gear is arranged at the front of the engine and consists of a revolving cam shaft driven from the crank shaft by two sets of spiral gears and an intermediate vertical shaft. The cam shaft is enclosed in a housing bolted to the exhaust belt, and operates the vertical valves in the cylinder heads by means of roller levers and tappets. A set of five cams is provided for each cylinder, which give cut-offs of 75% astern, neutral, 75% ahead for maneuvering, full load ahead, and half load ahead. The cam shaft is shifted bodily endways by levers actuated by a steam cylinder, the valve of which is controlled by a hand lever having a follow-up motion. Equal cut-offs at the head and crank ends of the cylinders are obtained by placing the roller for the head end valve  $4\frac{1}{2}^\circ$  ahead of its normal  $180^\circ$  position, the average difference in crank angle for equal cut-offs being  $9^\circ$ . The tappet of the head end valve has a clearance sufficient to make  $4\frac{1}{2}^\circ$  of the cam inoperative, so that the total time of opening of the head end valve corresponds to the cam angle minus twice the angle of offset, or  $9^\circ$ . The cams as well as the rollers are beveled off to facilitate the endwise movement of the cam shaft. This engine has proved thoroughly reliable in operation.

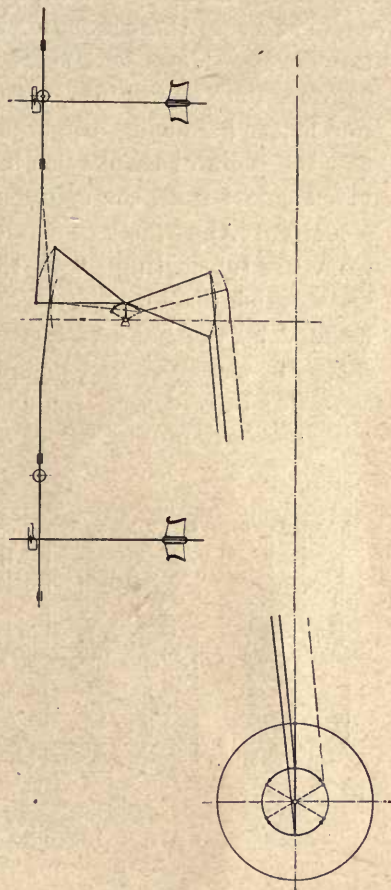


Fig. 21.

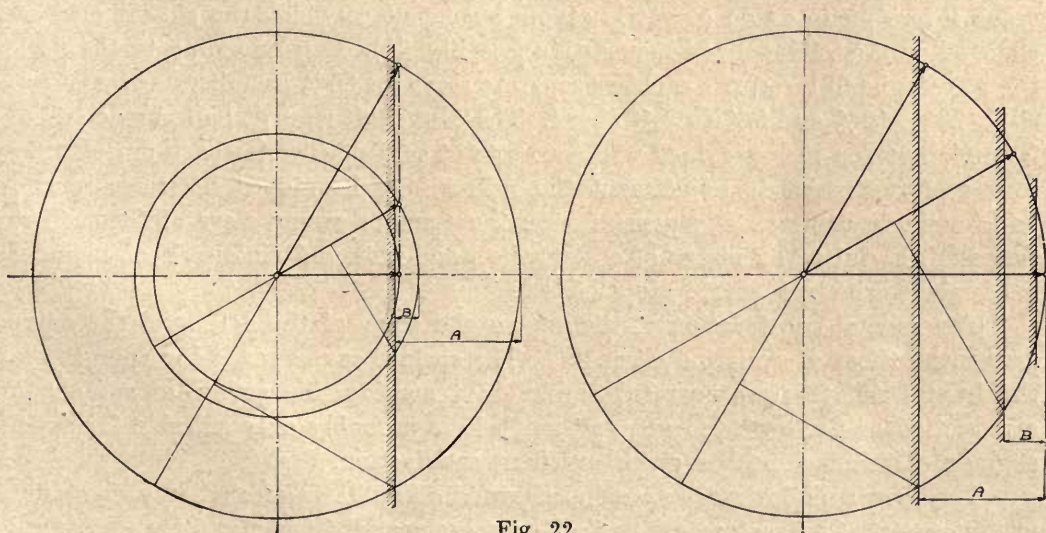


Fig. 22.

In Figs. 28, 29 and 30 is shown a four cylinder single-acting una-flow marine engine having the condenser incorporated in the frame. This engine was built by the firm of Karl Schmid of Landsberg for the steamer "Koriolan", and has a cylinder bore of 470 mm, a stroke of 350 mm, and develops 400 HP at 250 r. p. m. For better balancing, the cranks of each pair of adjacent cylinders are set at  $180^{\circ}$ , and the pairs of cranks are in turn set at  $90^{\circ}$ . A separate crosshead guide is provided, apart from the cylinder bore, and the piston is accordingly of stepped construction. Any water of condensation dripping from the pistons is thus kept away from the lubricating oil in the crank pit. The cranks have scoops formed upon them which dip into the oil and deliver it to the crank pins. A further advantage claimed by the builders for this type of construction is the lower working temperature of the crosshead piston and its removal from the hot cylinder walls. This type has proved very reliable, but the same may be said of the straight piston design shown in Fig. 31, if a different method of lubrication is employed. The

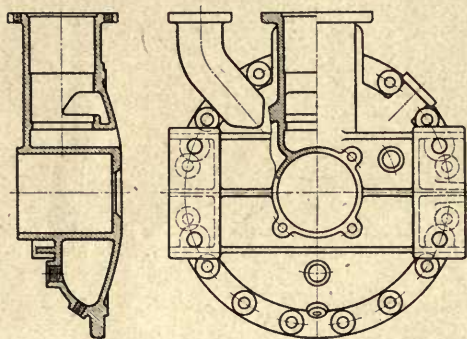


Fig. 24.

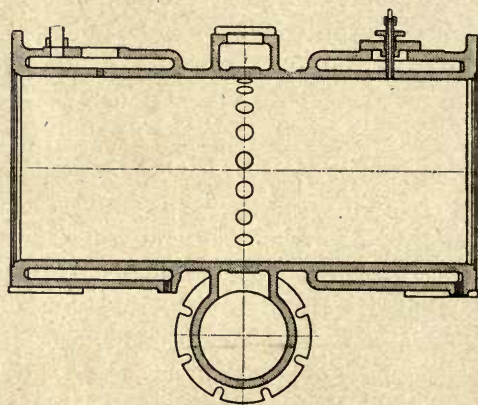


Fig. 25.

valves are located centrally in the heads and are operated by cams through bell crank levers mounted on eccentric pivots by means of which the cut-off may be changed or the valves made inoperative (see Fig. 30). Corresponding to the positions of the hand lever, the cam has separate steps for 60% cut-off astern, neutral, 60%, 20%, 10% and 5% cut-off ahead. The cam shaft runs at half engine speed, for which reason it is provided with two sets of cam profiles for each cut-off. By means of the eccentric adjustment the rollers may be moved horizontally and be brought into proper engagement with the cams or swung clear of them. The cam shaft is shifted by means of a handwheel and rack and pinion. Each cylinder is provided with a separate stop valve.

The general construction of the engine and some of the details of the valve gear recall those of a marine oil engine. The surface condenser is incorporated in the frame, and this arrangement results in a considerable saving of space and a reduction of the back pressure, although it is probably only suitable for small engines. This machine has given excellent satisfaction.

The four cylinder marine engine shown in Fig. 31 is of similar design, but in this case straight pistons are used. The valve gear shaft is also driven by spiral



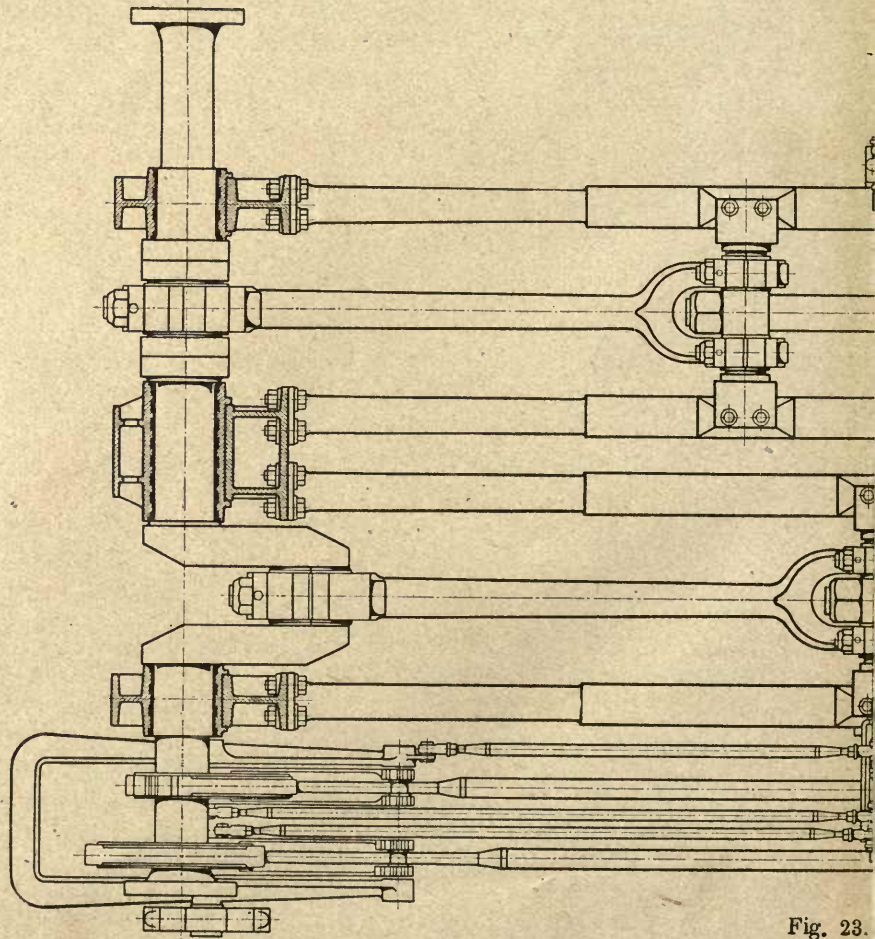
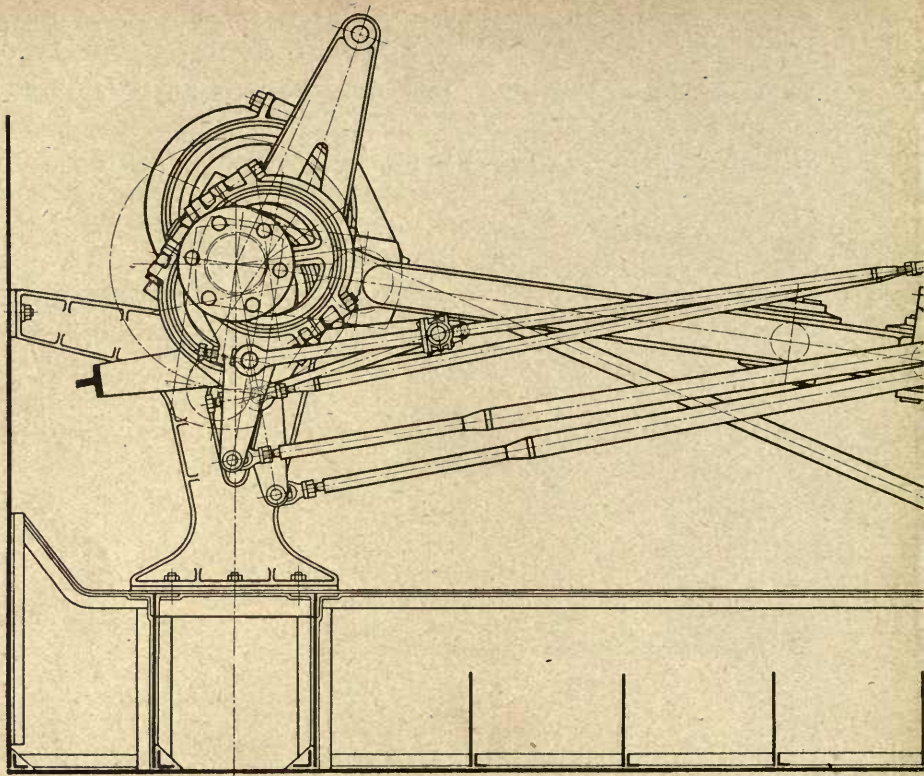
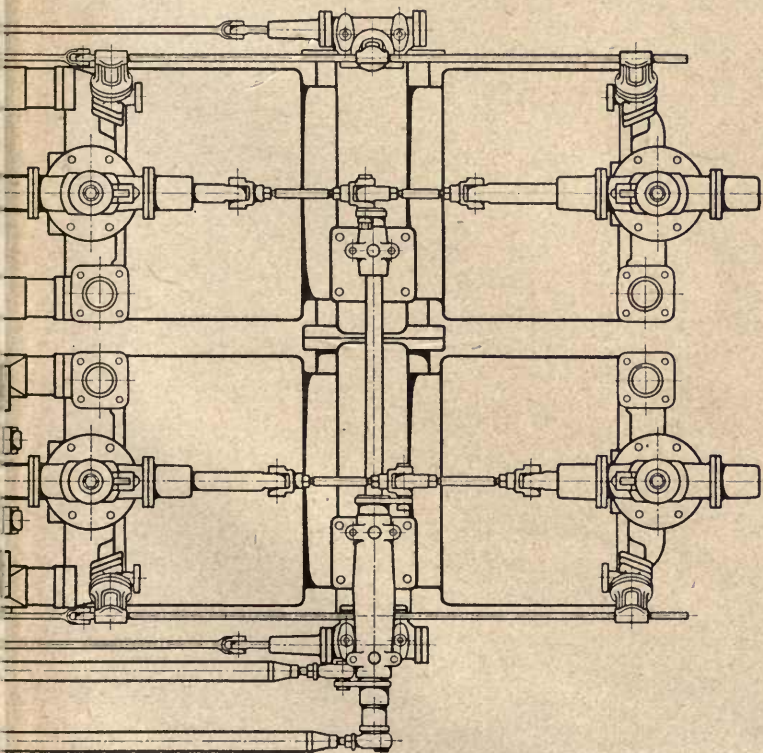
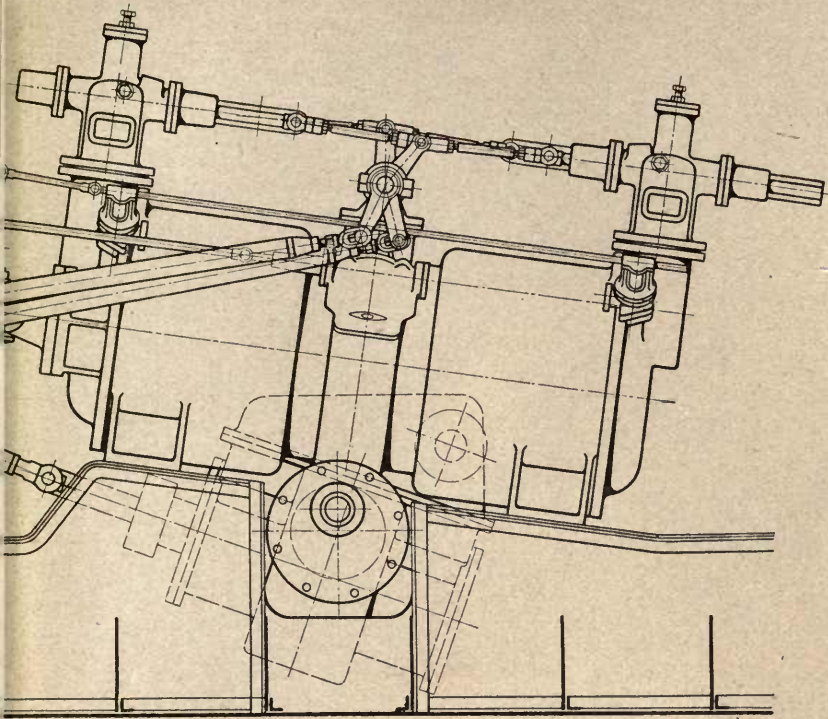


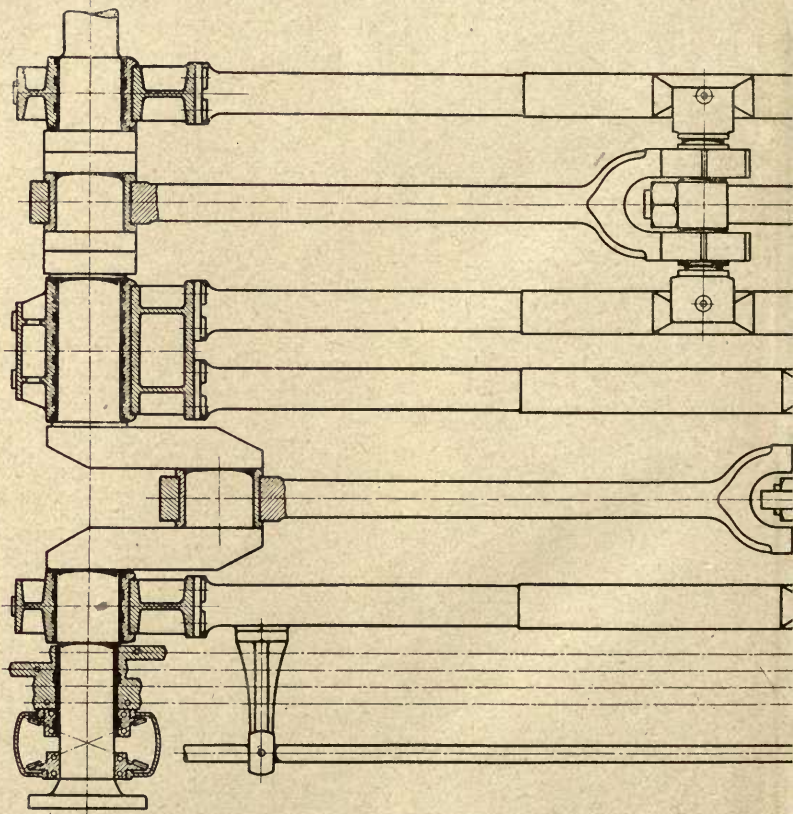
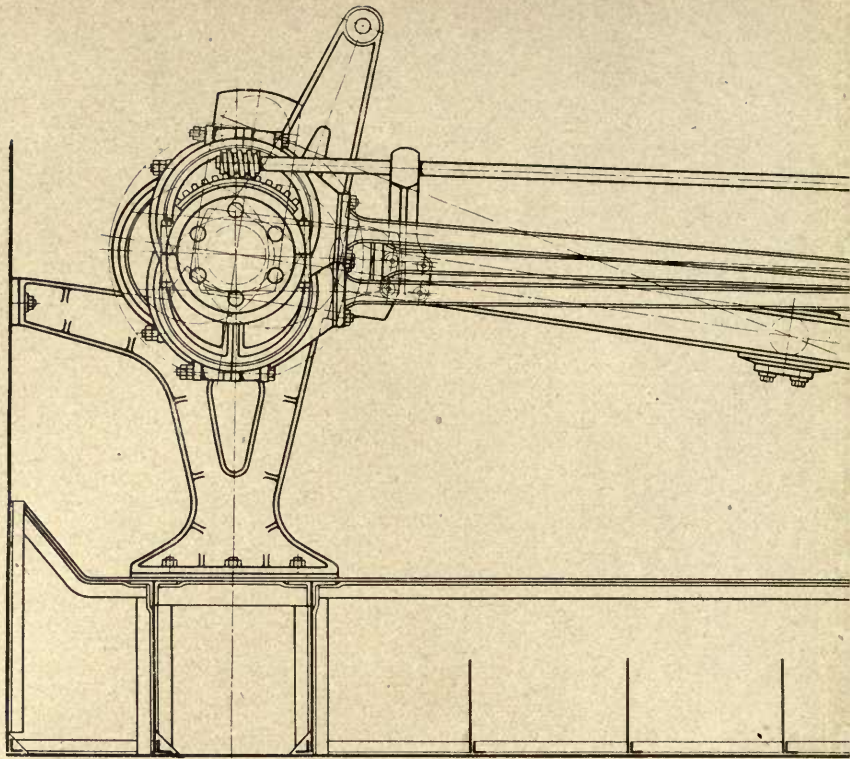
Fig. 23.

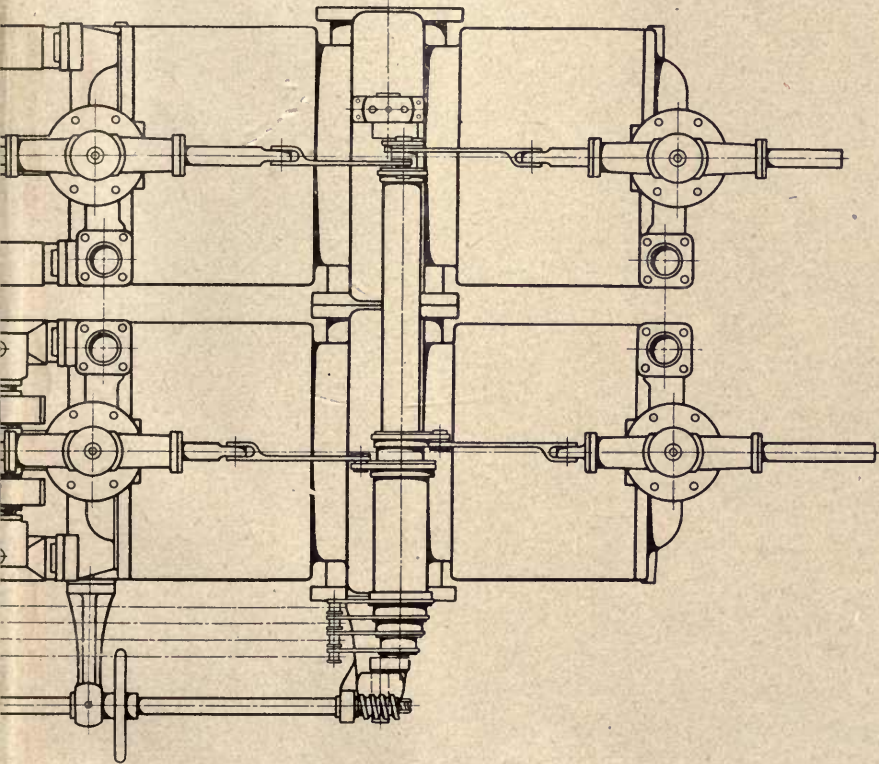
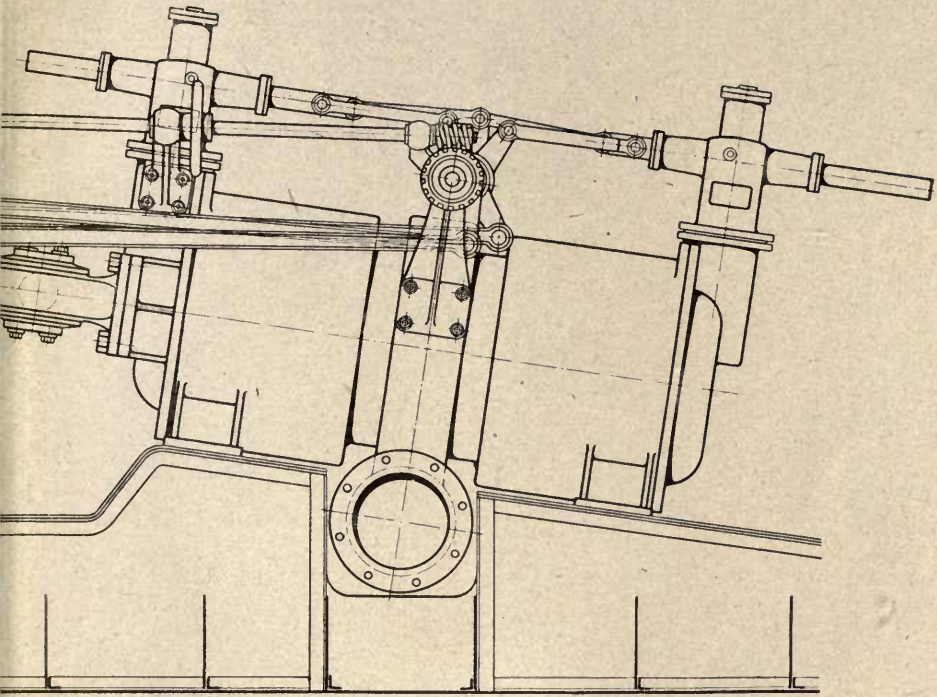














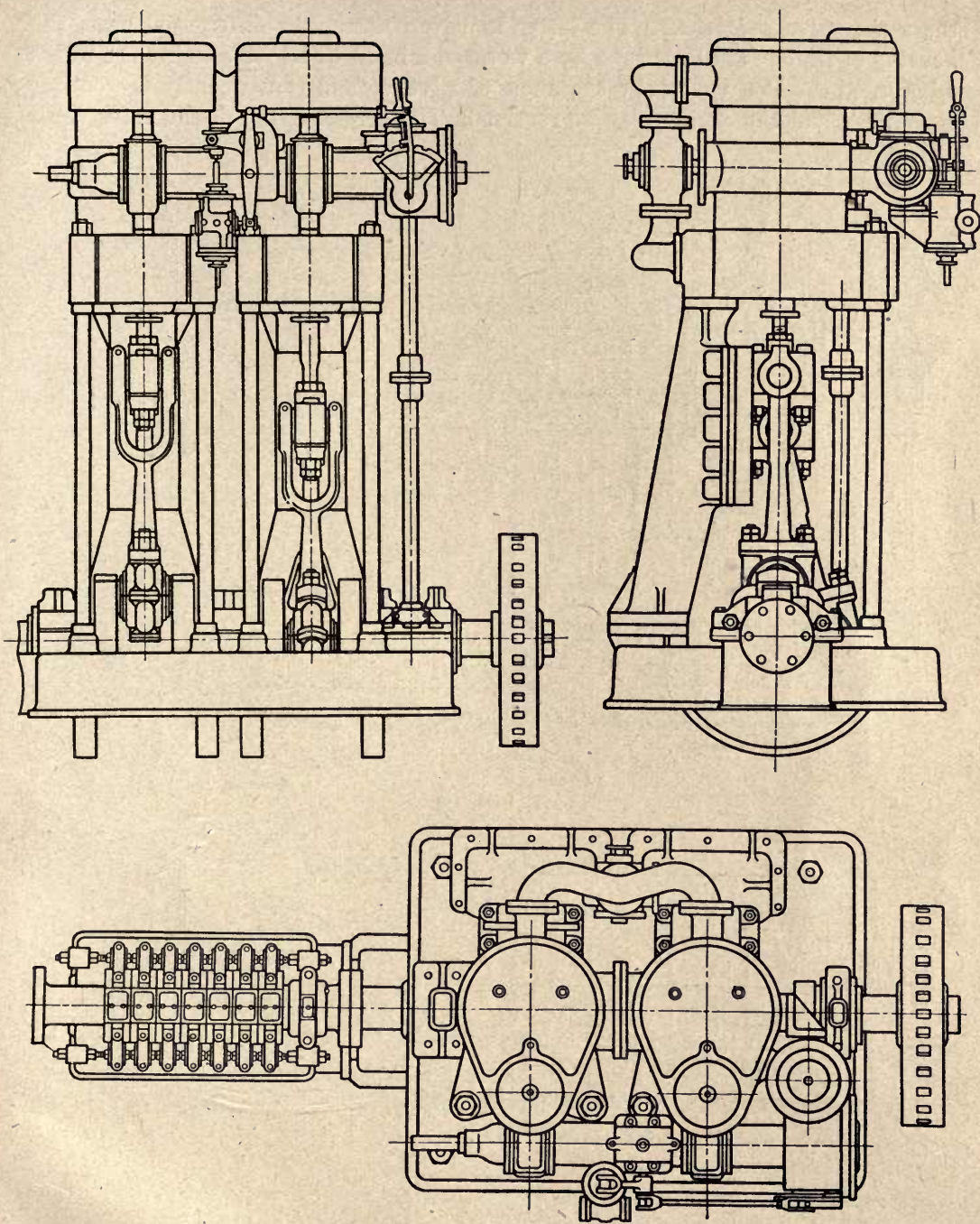


Fig. 27.

gearing, but in contrast to that of the engine just described, it runs at double the speed of the crank shaft. Single-beat high lift valves are arranged centrally in the cylinder heads and are operated by Lentz cam mechanisms by means of rocking levers mounted on eccentric pins, these levers being actuated by eccentrics on

the main valve gear shaft. The latter is driven through a differential gear, the housing of which may be turned by a worm and hand wheel for altering the phase relation to the shaft, whereby the angle of advance and consequently the cut-off is changed and the engine may be reversed. The necessary lap of the valve cams

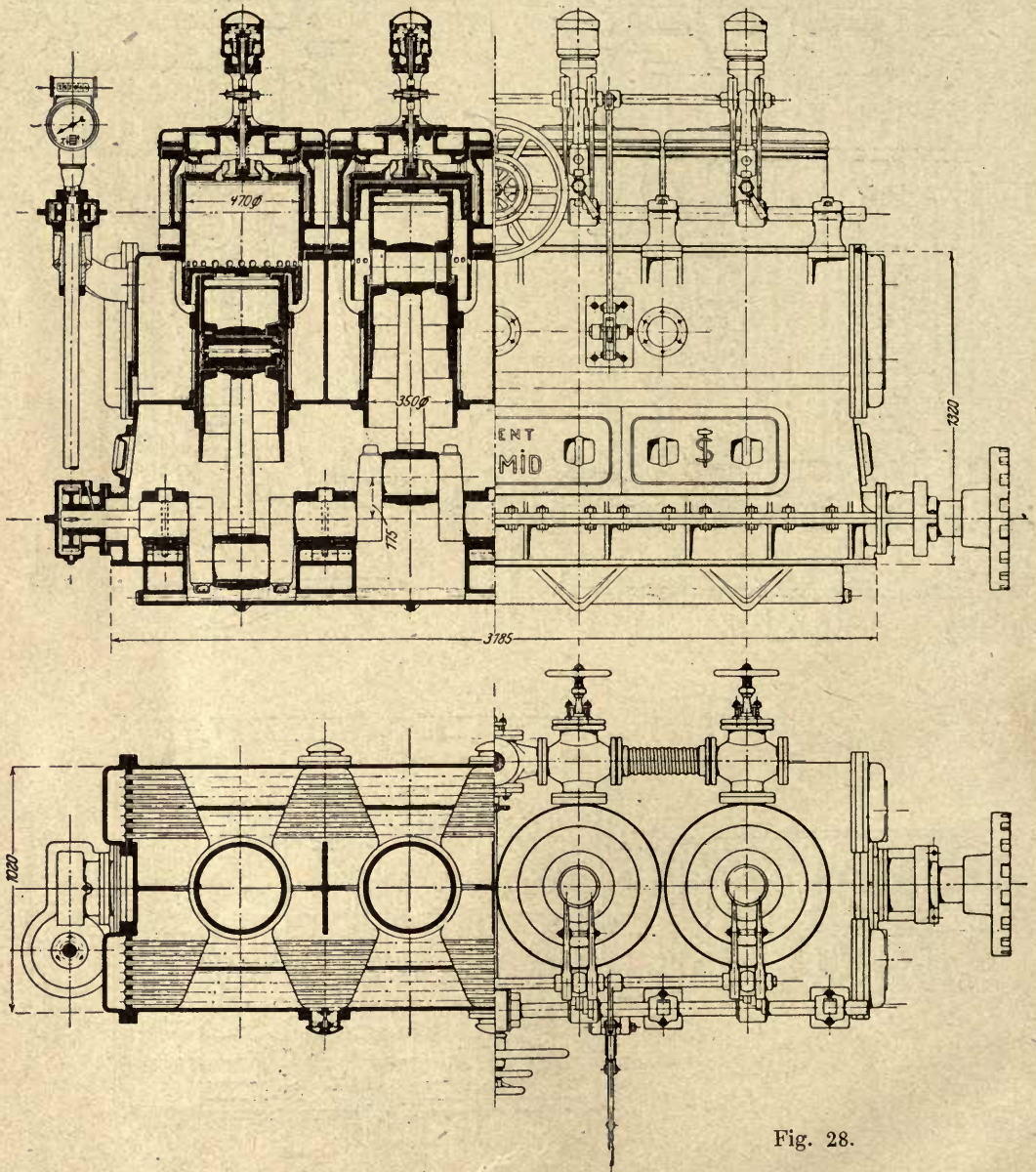


Fig. 28.

is obtained by communicating the rotative motion of the differential gear housing to the eccentrics on which the rocking levers are mounted, in such a way that the angle of advance of the latter always corresponds to that of the main eccentrics. The whole of the valve gear is enclosed in a housing. In consequence of the double speed of the valve gear shaft, the angle of cut-off is doubled and the valve



lift quadrupled, which thus permits of the use of a very small single-beat valve. The latter is unaffected by pressure and temperature changes and will therefore remain permanently tight. The clearance space and harmful surfaces are also materially reduced. This design has been developed in connection with the single-acting vertical two cylinder engine shown in Fig. 47 of Ch. II, 1, p. 165, under the heading of stationary engines. (See also the following chapter.)

In Fig. 32 is shown a design of a single-acting vertical six cylinder marine engine developed by the Stumpf Una-Flow Engine Company, Inc., of Syracuse, N. Y., in which straight pistons are also used. The double-beat valves are arranged horizontally in the heads and are operated by bell crank levers actuated by tapered cams mounted on a cam shaft running at engine speed. The valves are easily removable from the opposite side of the cylinders, and each cylinder head is detachable with the valve in place without disconnecting the gear, so that the piston is easily accessible. The cylinders are all bolted together at their exhaust

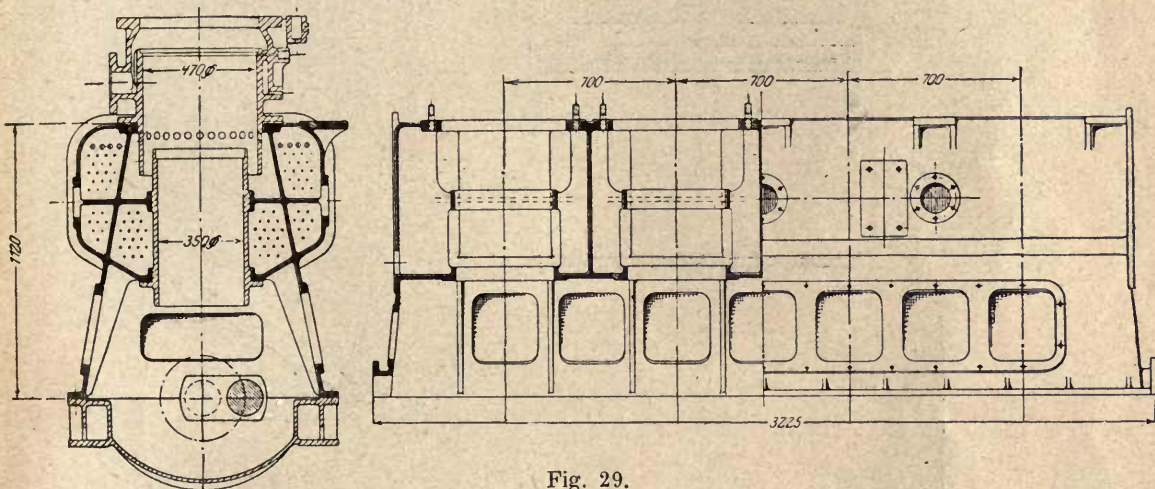


Fig. 29.

belts, where the temperature is lowest, and are tied to the cast steel base plate by substantial bolts with tubular distance pieces. Cast steel side members are arranged to take the side thrust of the piston and also permit of the attachment of side plates for enclosing the driving parts. The cam shaft with its tapered cams may be moved bodily endways by means of a hand wheel and worm gear, whereby the cut-off may be changed and the engine reversed. The six cylinders have a bore of 22" with a stroke of 24" and develop 5000 HP at 250 r. p. m. All problems concerning manufacture and operation have been satisfactorily solved in this design.

In all single-acting engines of this kind the greatest care must be exercised in the design and manufacture of the piston and rings, which must make a vacuum-tight joint with the cylinder. Air leakage past the piston into the vacuum touches the engine at a vulnerable spot.

In the case of high powered engines, if it is desired to use the Schlick balancing arrangement, this can be carried out with a four or six crank una-flow engine. A four cylinder engine of this kind is shown in Fig. 33. Hollow pistons can be

made very light, as was mentioned in dealing with locomotive details. Such light pistons might be employed for the outside units, while the necessary additional weight can be easily added in the cavities of the pistons of the middle cylinders without alteration of any other parts.

The effect of the inertia forces of the reciprocating masses upon the loads on the driving parts is more favorable in large una-flow engines than in the modern triple or quadruple expansion engines, where the inertia and steam pressures are

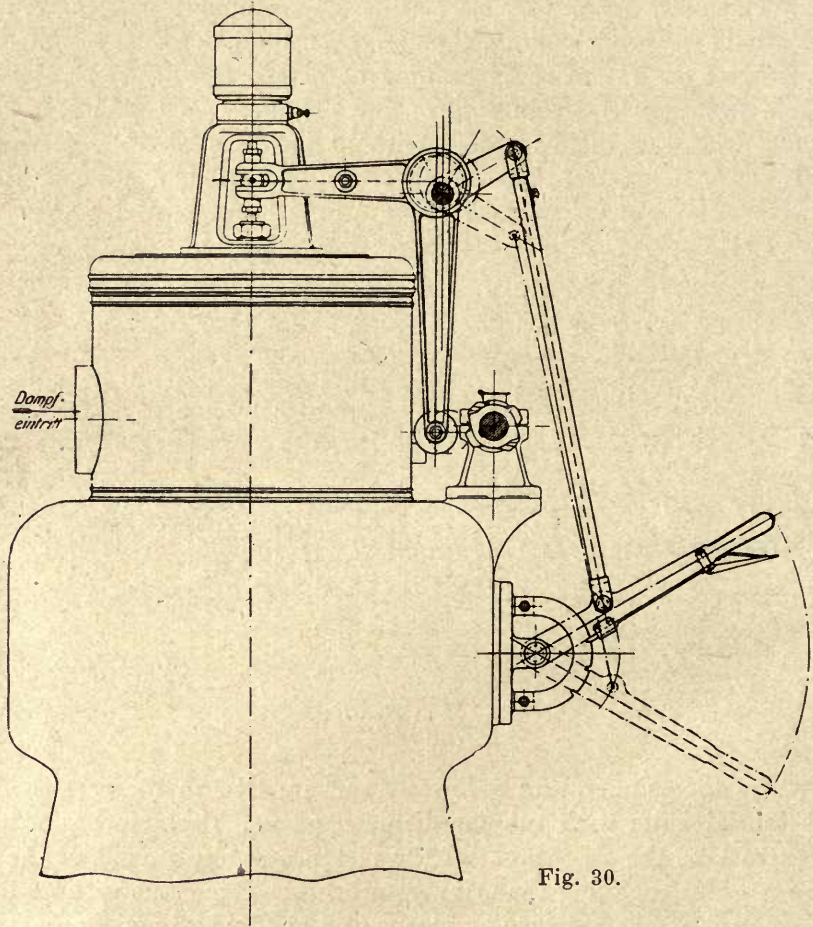


Fig. 30.

additive in the latter part of the stroke. The actual maximum stresses occurring in regular running are much smaller in large una-flow engines. At the same time piston speeds of  $5\frac{1}{2}$  m/sec may be employed.

Investigation proves that for cut-offs later than normal, the load distribution on the driving parts of a una-flow engine is more even, while for early cut-off and at low speeds of revolution the multi-stage engine is better in this respect.

For small and medium sizes and low speeds, the three cylinder arrangement has many advantages, such as better load distribution on the driving parts, more uniform torque and a smaller shaft diameter.

With three, four, or more cylinders, the una-flow marine engine offers a great reserve of power. Since each cylinder and set of driving parts forms a complete unit in itself, any one or more of these units may be disconnected if requiring repairs, while the cut-off in the remaining ones may be increased to make up for the loss of the one out of action. For instance, it is possible to cut out two units of the four cylinder engine just described, and to increase the cut-off in the remaining ones from 10 to 20% to make up for the difference.

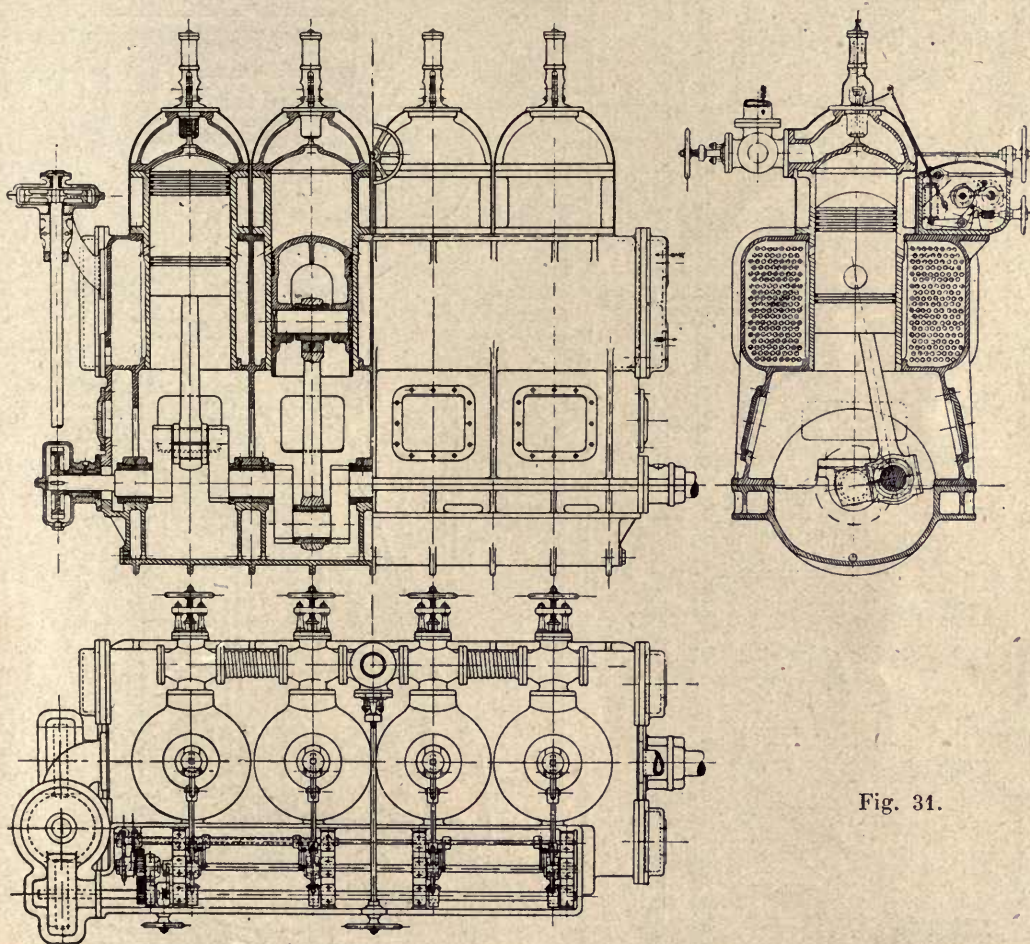


Fig. 31.

In comparison with that of the multi-stage engine, the reversing gear of the una-flow marine engine is much more simple and reliable. In the latter the process of reversing only applies to the inlet valves. Since in this type of engine there are no intermediate receiver pressures to be taken into account when reversing, and as the compression is always constant, the difficulties caused by excessive compression pressures in the first cylinders of multi-stage engines are avoided. Reversing takes place much more smoothly, especially since the balanced inlet valves offer very little resistance. Consequently the valve gear parts are subject to very little wear, as is proved also by experience.

In a quadruple expansion engine the diagram factor of the indicator card shown in Fig. 34 may be taken as an average of 55 to 60%. The remainder is

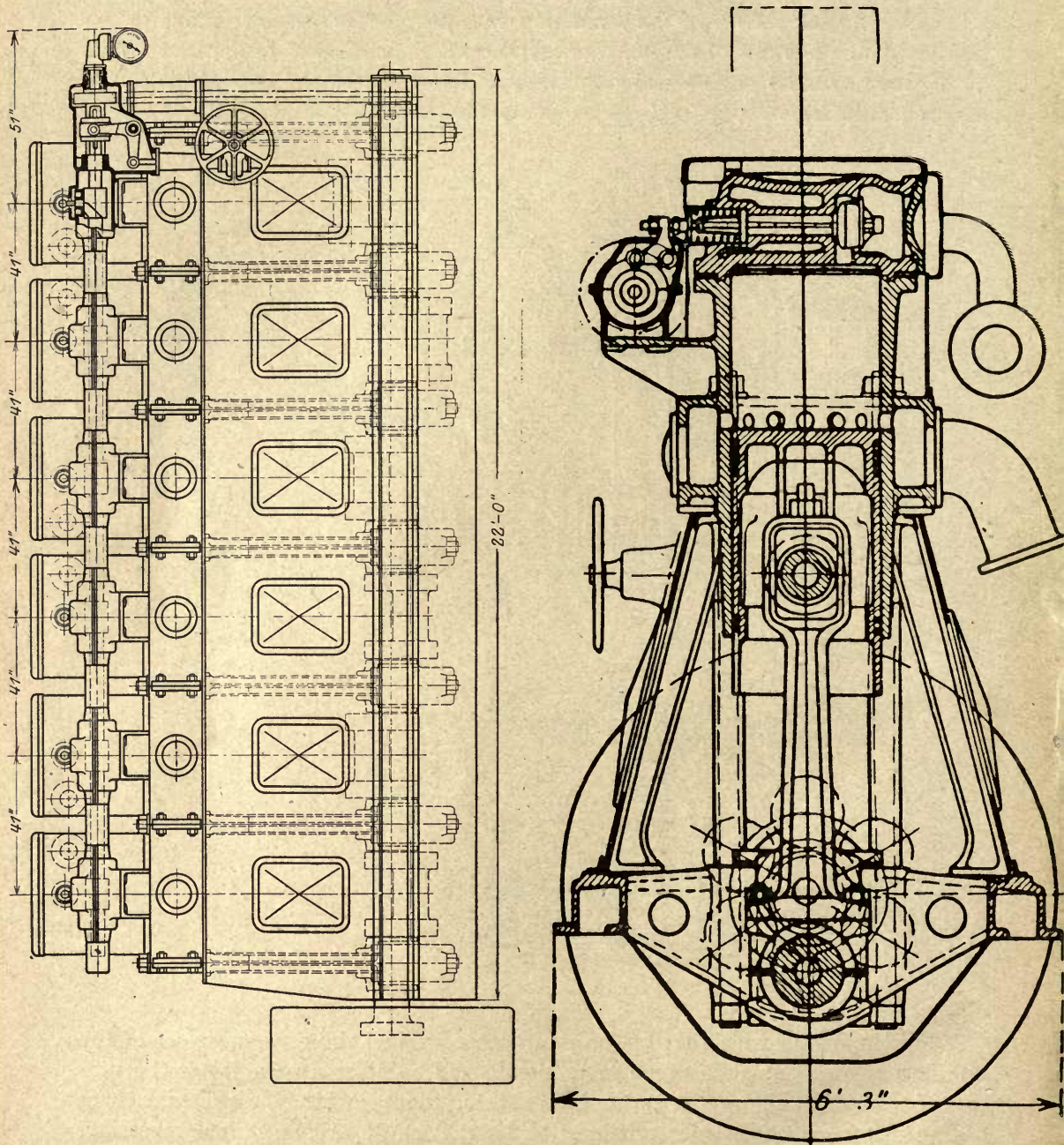


Fig. 32.

lost by throttling in the valves and pipes, and by condensation losses. On the other hand, the diagram factor of the indicator card (Fig. 35) of a una-flow engine may reach 80% with a good vacuum, i. e., a difference of 20 to 25% in favor of

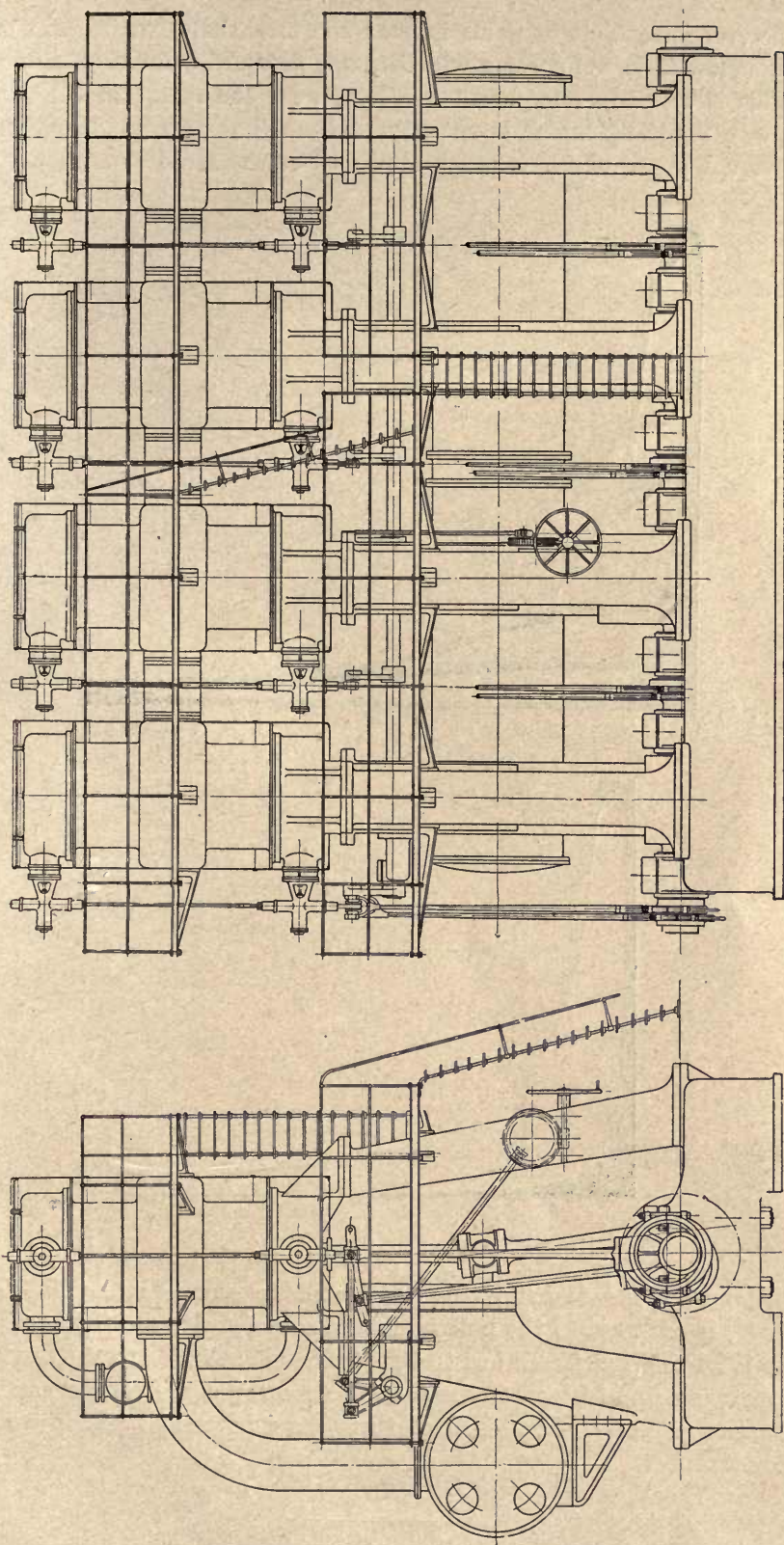


Fig. 33.

the una-flow engine. This explains in part the essentially smaller dimensions of a una-flow cylinder in comparison with the low pressure cylinder of a multi-stage engine. This is also to some extent the reason for the fact that the steam consumption of a una-flow engine is not greater than that of a quadruple expansion engine of equal power, both for saturated and superheated steam.

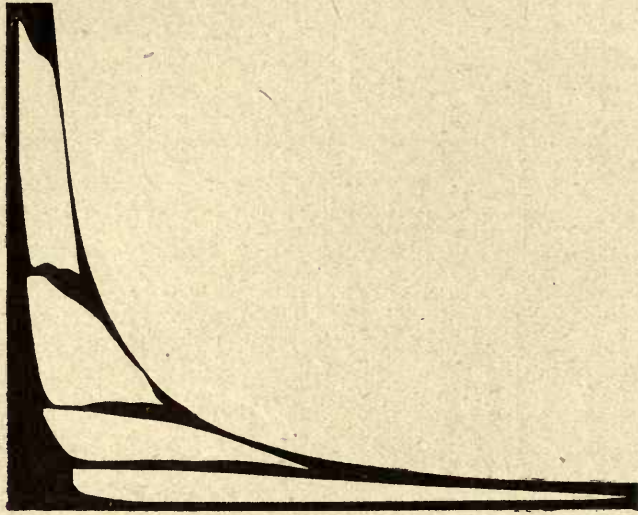


Fig. 34.

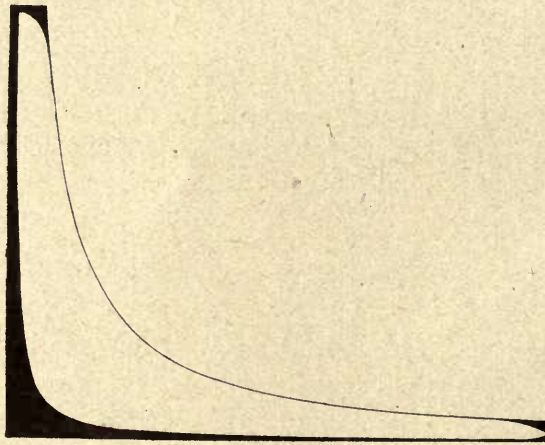


Fig. 35.

By distributing the steam flow to several cylinders, smaller inlet valve dimensions are obtained, in contrast to the bulky valves necessary with multi-stage engines, in which the total working steam has to pass from one cylinder to the next in series.

Another valuable feature of the una-flow marine engine is the small number of spare parts required, since each of them may be used with any one of the cylinder units.

## VI. The Una-Flow Engine with Single-Beat Valves and Double or Triple-Speed Lay Shaft.

The usual types of valve gears with fixed lap necessarily give very small valve lifts at early cut-offs. For instance, at 10% cut-off the valve opening  $a'$  is only  $0.065 r$  (see Fig. 1). In order to obtain the necessary valve area when slide valve gears are used, a large travel and considerable lap must be provided and this results in large friction losses and leakage. In poppet valve gears very steep cams become necessary. In order to alter the cut-off, the resultant eccentricity has to be changed; and since cut-offs up to 50% must be provided for in many cases, the eccentric travel for early cut-offs is short and therefore the resultant valve lift is small, i. e., the inadequate effect of the above measures is partly or wholly nullified by the necessity for a long range of cut-off.

A solution of the problem on this basis is impossible, since the power necessary to lift the valve through the required height in a given time cannot be applied to it in this way. Instead of trying to accomplish the

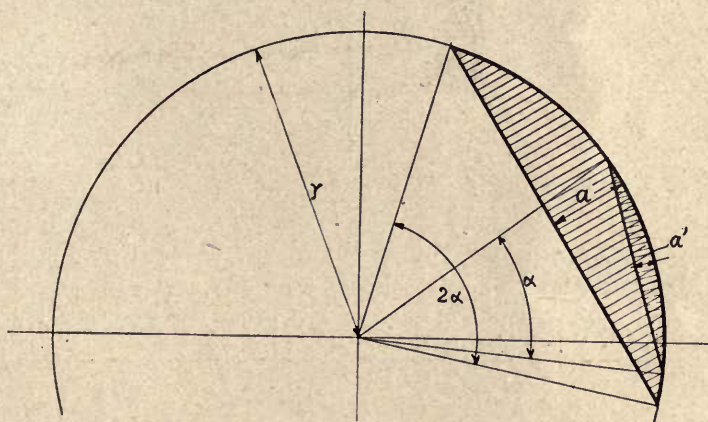


Fig. 1.

work with small valve lifts and large forces, it would be better to use large valve lifts and small forces. If therefore the lay shaft is arranged to run at double the engine speed, then the period of valve opening extends through twice the angle  $a$  and the opening increases from  $a'$  to  $a$ , as shown in Fig. 1. Since

$a = 2r \cdot \sin^2 \frac{\alpha}{2}$ , therefore  $a = 4a'$  approximately within fairly wide limits. By

doubling the lay shaft speed, the opening of the valve is thus quadrupled. In order to prevent the valve from opening twice during one revolution of the engine, a cut-out eccentric is interposed in the valve gear, running at engine speed, which increases the useful stroke of the main eccentric and makes every second stroke of the latter inoperative. In Fig. 2 is shown a Zeuner diagram for such a valve gear, in which the two outstrokes of the resultant eccentric are shown in full lines while the instrokes are dashed. Every alternate outstroke

produces a valve opening of 19 mm while the following stroke falls short of the lap line by 4 mm. The constructional simplicity of this gear is evident from Fig. 3.

The double-speed lay shaft carries a shaft governor which varies the throw and angle of advance of the main eccentric in the usual manner. The latter operates the cam lever in the valve bonnet indirectly through a double armed lever,

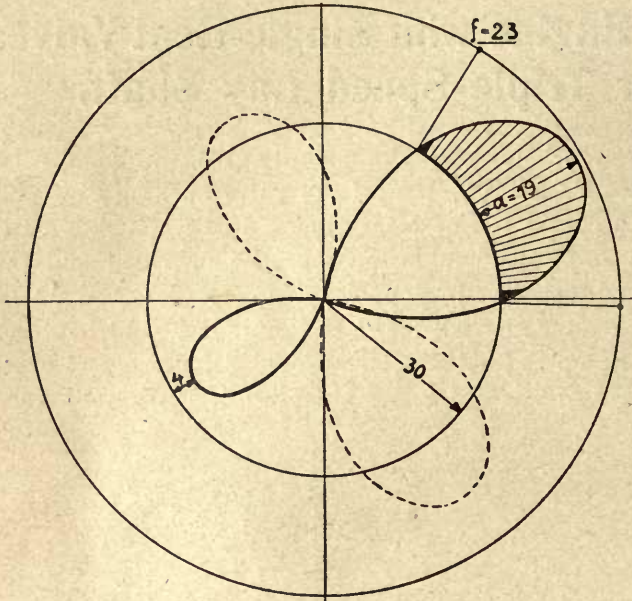


Fig. 2.

pivoted on one of the cut-out eccentrics which are forged in one piece with their shaft and revolve at engine speed. The position of the gear shown in Fig. 3 corresponds to the lifting stroke, in which the cut-out eccentric magnifies the motion of the main eccentric. After the crank has turned through 180°, the main eccentric is again in the same position, but the cut-out eccentric has also turned through 180° and thus counteracts the motion of the main eccentric with the effect that the valve remains closed. Figs. 3 and 4

respectively show the gear and the valve of a una-flow engine having a cylinder bore of 400 mm, a stroke of 500mm, and running at 150 r. p. m. The main dimensions of the valve gear are given in the following table:

	Main Eccentric Shaft (Double speed)	Cut-out Eccentric Shaft	
		Crank End	Head End
Throw of eccentric . . . . . mm	37	14	12
Angle of advance . . . . . deg.	30	60	90
Lap . . . . . mm	30	—	—
Opening $a$ . . . . . mm	—	20	17
Maximum cut-off . . . . . %	—	21	24.5

The cut-out eccentric shaft is driven from the lay shaft by a train of spur gears; and where auxiliary exhaust valves are employed they may be operated from the former. Since the governor runs at double the speed of that of an ordinary lay shaft engine, its regulating force is quadrupled, and it will therefore hardly be affected by any valve gear reaction. The ratio between minimum and maximum eccentric travel of the shifting eccentric of an ordinary valve gear may be designed to give a maximum cut-off of 75%. If the same ratio is used for the main eccentric which runs at double speed, the corresponding crank angle is



equivalent to a maximum cut-off of only 25%. This may be improved upon by a suitable change in the angle of advance of the cut-out eccentric, and the maximum cut-off may thus be increased to about 35%.

For ordinary stationary engines a maximum cut-off of 25% would seem to be sufficient, since with a normal cut-off of 10% at rated load an overload of more than double this amount may be carried. In special cases the cut-off may be

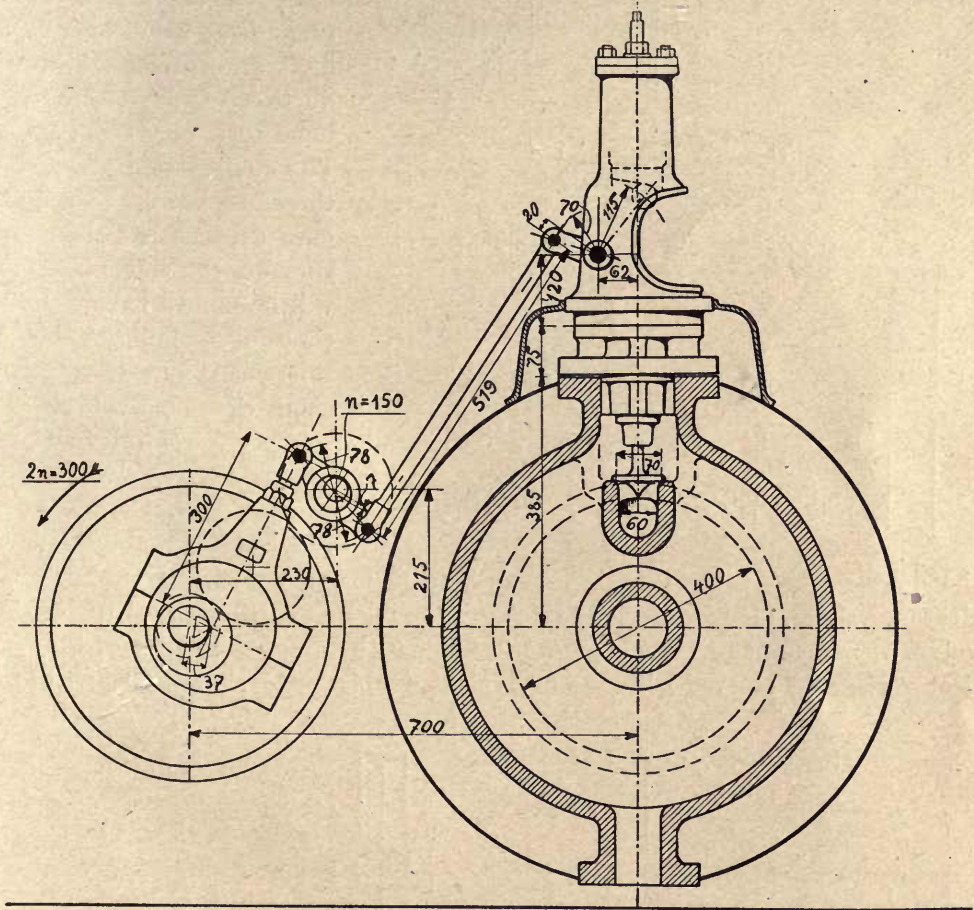


Fig. 3.

materially increased by running the main eccentric shaft at engine speed and the cut-out eccentric shaft at double speed (Fig. 11). In this manner it becomes possible to reach a maximum cut-off of 70%, but in this case the valve lift will be only doubled instead of quadrupled. Apart from the increase in the weight of the valves, the forces necessary to accelerate them will consequently be doubled. Since these forces only amount to a part of the total valve gear reaction, the governor, now revolving only at engine speed, should still be able to handle them satisfactorily, provided that there is sufficient frictional resistance in the shifting eccentric. A design comprising a secondary eccentric rotatably mounted upon a primary eccentric is suitable for this purpose.

The most satisfactory arrangement, however, is to operate the governor shaft at twice the engine speed, since this quadruples the regulating forces as well as the valve lift. The high lift obtainable in this manner allows of the use of a single-

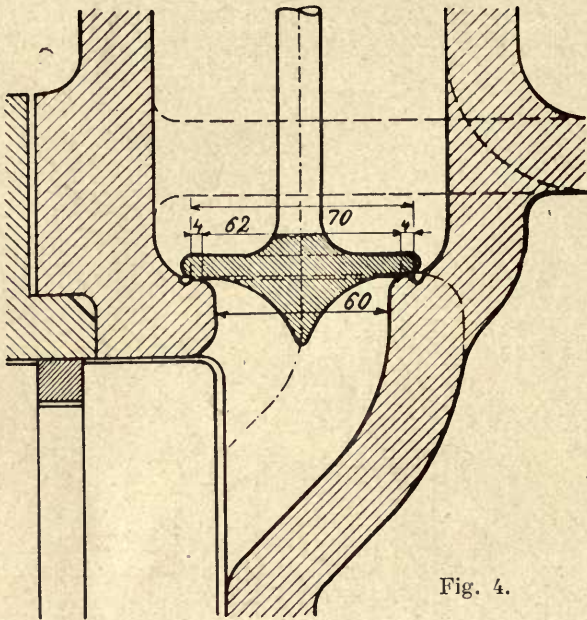


Fig. 4.

beat valve, the diameter of which need only be one half that of the equivalent double-beat valve. Such a small single-beat valve is extremely light and permits of the reduction of the clearance volume to a very small amount. The compression pressure will therefore run up to a high figure so that the steam pressure on the single-beat valve will be almost balanced at the time of opening. This consideration will show that a small clearance volume is absolutely essential to the use of single-beat valves and that the latter can only be employed in combination with

the double-speed valve gear. A good vacuum is desirable in view of the small clearance space. It also demonstrates why previous experiments with single-beat valves were bound to fail. Figs. 4 and 5 show the great simplicity of the single-beat valve as compared with the equivalent double-beat valve, both figures being

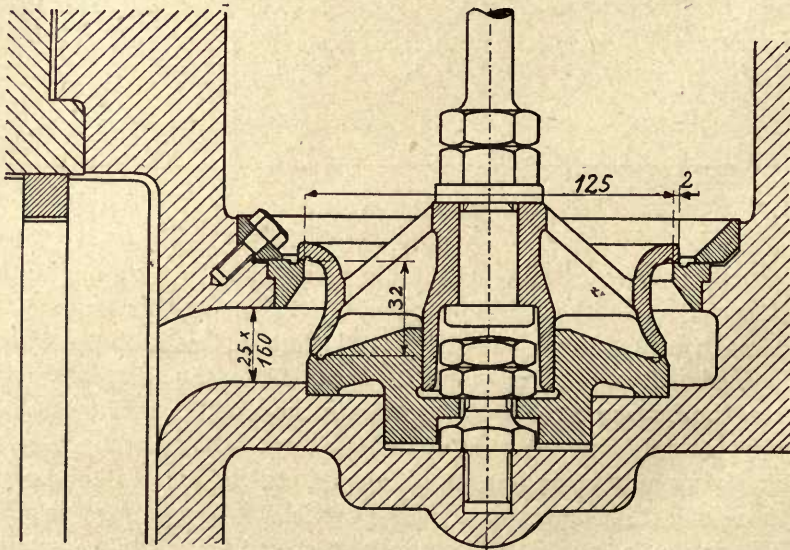


Fig. 5.

drawn to the same scale. Fig. 6 shows the plain character of the cylinder head castings, as well as the short and simple steam passages and the small amount of clearance volume and harmful surfaces. The reduction of surface loss, volume loss and leakage, as well as the losses due to throttling may be expected to improve the steam consumption by 0.4 to 0.5 kg/HP-hour.

The single-beat valve has only half the diameter of the double-beat valve. Despite the small dimensions of the valve, the pressure drop during admission will be less on account of the direct flow of steam with the least possible changes of area and direction, and the well rounded corners.

A large nozzle, in general, has less friction losses than a small nozzle, since the friction of the walls is relatively less in comparison with the quantity of steam passing through it. For this reason the friction losses of the single-beat valve with its more compact steam jet must be less than those of the double-beat valve

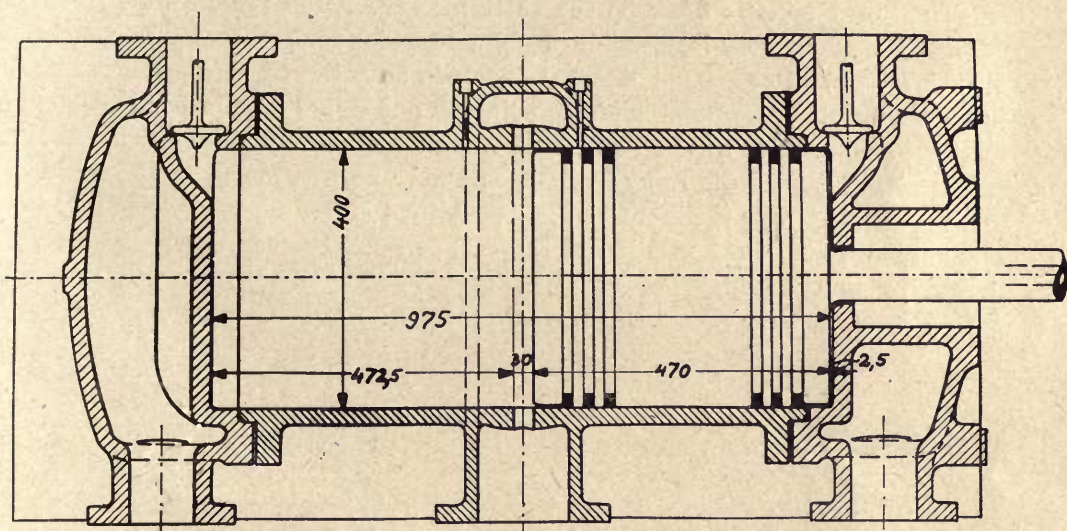


Fig. 6.

where the flow is split up. The even profile of the cross-section of approach to the valve seat and the following diffuser-like enlargement of the steam passage will also cause a gradual increase in kinetic energy, with a subsequent change of the same into pressure energy, so that the total amount of work changed into heat due to friction will be small.

The reduction of throttling losses also benefits the governor action, since the pressure difference at the valve during the latter part of admission constitutes the major part of the load to be handled by the governor. In comparison with this the forces necessary to lift the valve are small, mainly because the clearance space is filled with steam at a pressure almost equal to that of the live steam, so that an infinitely small lift of the valve is sufficient to allow the pressures to equalize fully. On the other hand, the increasing pressure difference at the valve during closing imposes an increasing load upon the governor, if it is not checked by frictional resistance in the mechanism. Since the forces on the valve depend

upon the lift, the diameter, and the pressure difference, there will be a best diameter for which the loads on the valve become a minimum.

A further part of the valve load is caused by the valve spring, which should therefore not be made heavier than necessary. The single-beat valve, on account of its light weight, also improves conditions considerably, since the forces necessary to accelerate it are smaller than those of the equivalent double-beat valve. A valve spring calculation has already been given in Chapter I, 5, but the method there employed is not applicable in this case, since the combined motions of two eccentrics revolving at different speeds have to be dealt with. A sketch of the valve gear mechanism is shown in Fig. 7 and corresponds to the arrangement shown in Fig. 3. Noteworthy is the gentle rise of the cam profile *L*, which in this case has a lifting radius of  $35 - \frac{34}{2} = 18$  mm.

The first step is to draw up the valve lift curve. For this purpose the movement of the whole gear is determined point by point for crank angles of  $10^\circ$  each. This corresponds to an angle of  $20^\circ$  at the main eccentric on account of the double speed of the latter. The paths of the points *B* and *D* are obtained in this manner. In the present case it will be found that when the crank has turned through about  $60^\circ$ , the center *K* of the roller is again in the same position as at the start, and the investigation will therefore be restricted to a crank angle of from  $0^\circ$  to  $60^\circ$ . The valve lift *h* for any position of the gear is the distance, measured parallel to the valve stem center line, between the curve *L* and an arc described with the radius *JK*. The curve *L* is drawn through the center of the roller equidistant to the

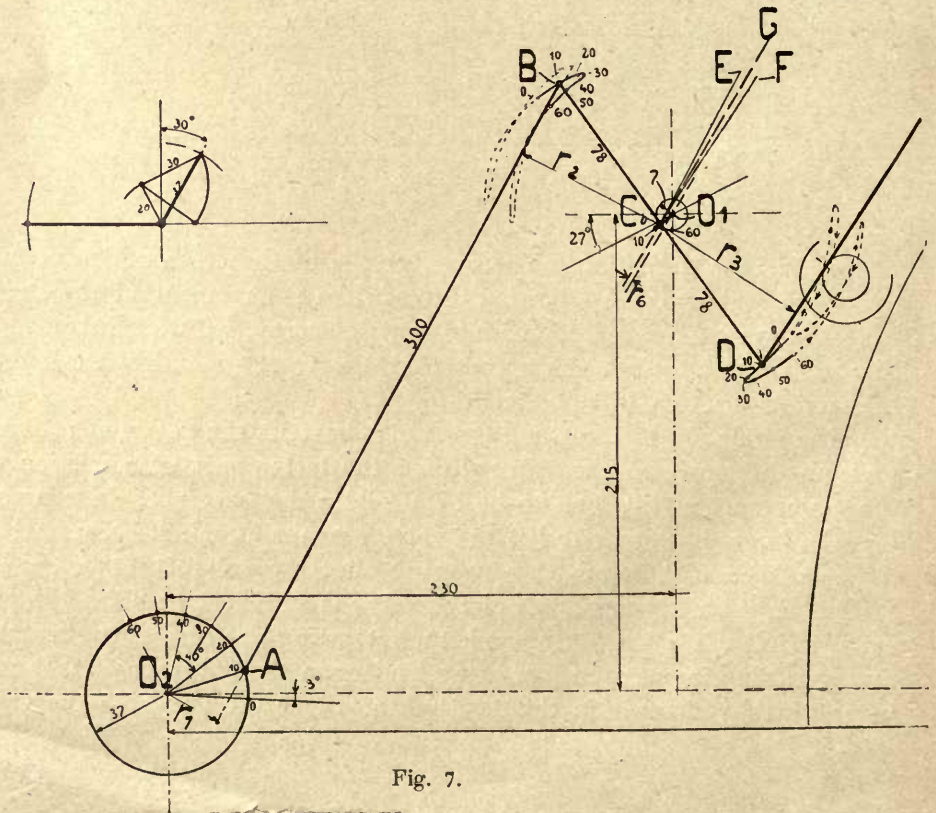


Fig. 7.

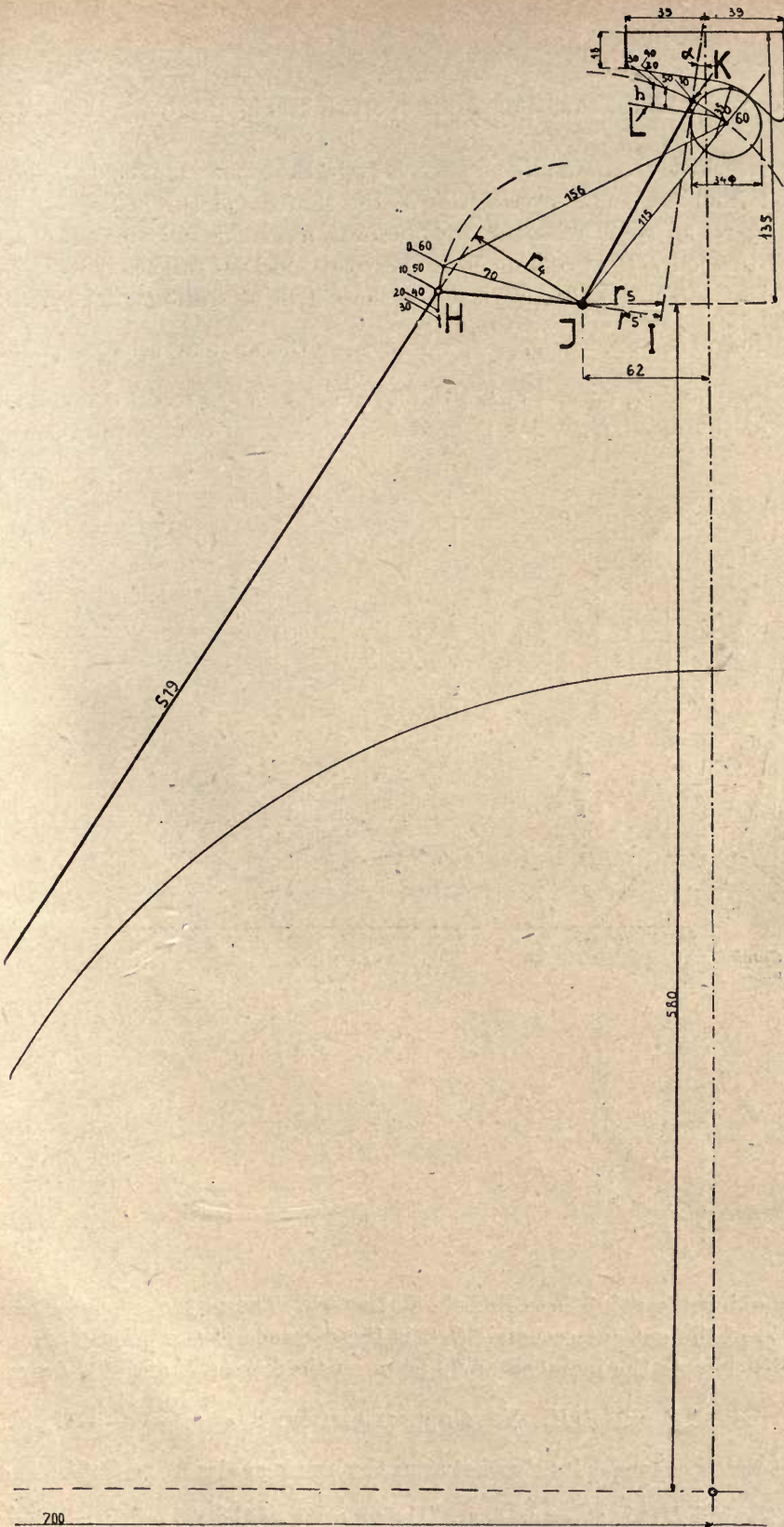


Fig. 7

cam profile. The valve lifts thus found are plotted in Fig. 8, giving the curve marked *h*.

The valve velocities are determined essentially in the same manner as before, being calculated from the angular velocities of the shafts and the instantaneous lever arms  $r_1, r_2, r_3, r_4, r_5$ . The latter are obtained from the full size drawing. The velocity of the rod *DH* is combined of the two velocities imparted to it by the two eccentrics. First assuming the cut-out shaft 0 to be stationary, then the velocity of the rod *DH* is  $v_2 = \omega_2 r_1 \frac{r_3}{r_2}$ , where  $\omega_2$  is the angular velocity of the main eccentric shaft and  $r_1, r_2,$  and  $r_3$  are the lever arms. The second component of the velocity of the rod *DH*, which is produced by the cut-out eccentric, may

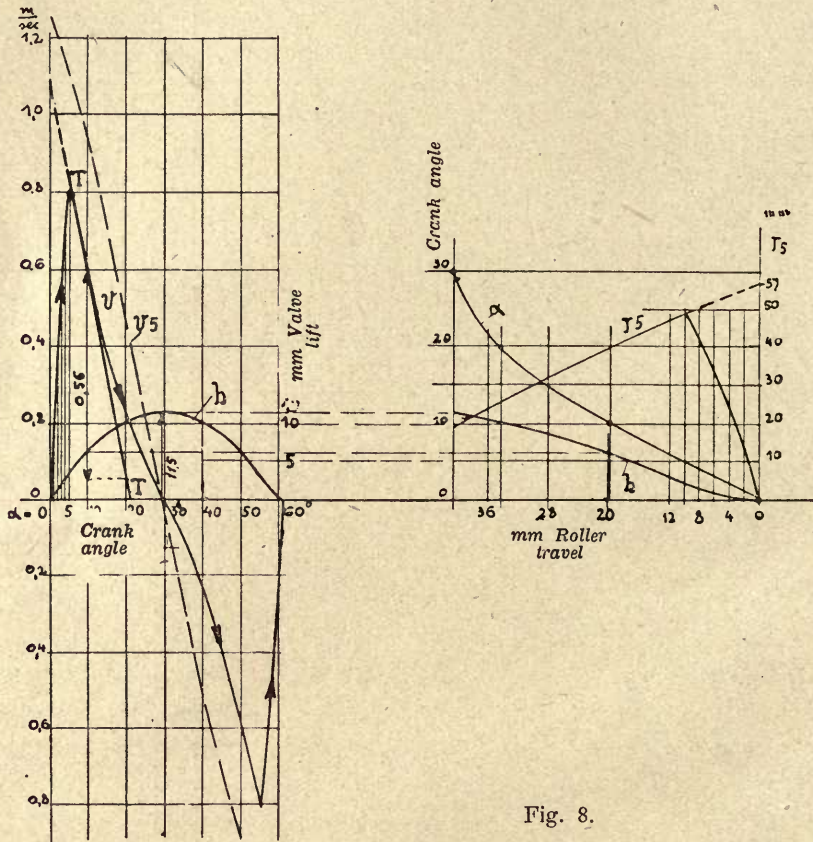


Fig. 8.

be found by assuming the point *B* to be held stationary. The instantaneous effective lever arm  $r_6$  of the cut-out eccentric  $O_1C$  is the distance of the point  $O_1$  from the line *CG* which bisects the included angle between the lines *CE* and *CF* drawn parallel to the rods *AB* and *DH*. Very approximately,  $v_1 = \omega_1 \frac{r_2 + r_3}{r_2} \cdot r_6$ . It should be noted that  $r_6$  changes its sign between the crank angles  $0^\circ$  and  $60^\circ$ . The real velocity of the rod *DH* is  $v_5 = v_1 + v_2$ . The velocity of the valve is  $v = v_5 \cdot \frac{r_5}{r_4}$ .

In the practical application of this method it will be found that increments of the crank angle of  $10^\circ$  are too coarse to permit of accurate determination of the valve movement during the lifting period. It is advisable to determine the rapidly varying lever arm  $r_5$  for every 2 mm of roller travel, as is shown at the right in Fig. 8. It will also be found best to continue the  $r_5$  line back to the zero ordinate as shown dashed. The relation between the roller travel and crank angle is next determined, giving the curve  $\alpha$  at the right of Fig. 8 and the calculated velocities  $v$  are then plotted in the diagram at the left. The points of change of curvature of curve  $r_5$  and of the velocity curve  $v$  in this case correspond to a crank angle of  $5^\circ$ . The imaginary extension of the  $r_5$  curve to the zero ordinate permits of the continuation of the velocity curve to zero crank angle, as indicated by a dashed line, and thus facilitates the location of a tangent.

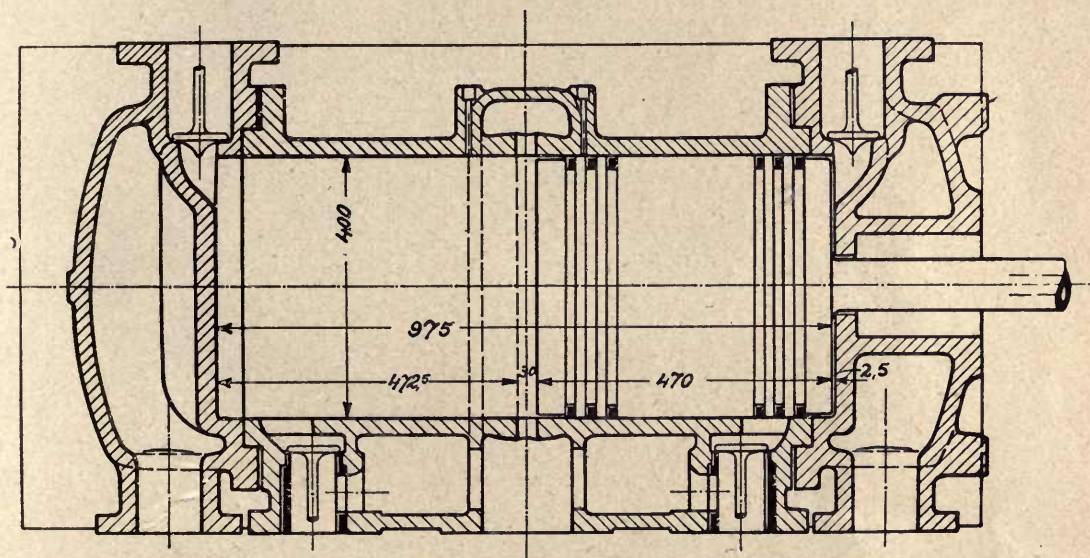


Fig. 9.

The tangent  $T-T$  drawn at the steepest part of the velocity curve gives the maximum retardation of the valve to be taken care of by the spring. In the present case, with the engine running at 150 r. p. m., a crank angle of  $10^\circ$  corresponds to  $\frac{60}{150} \cdot \frac{10}{360} = \frac{1}{90}$  sec. From the diagram the change of velocity for a crank angle of  $10^\circ$  is found to be 0.56 m/sec, and therefore the acceleration =  $0.56 \times 90 = 50.4$  m/sec<sup>2</sup>. The corresponding force required to accelerate a valve having a weight of  $G$  kg is  $P = G \cdot \frac{50.4}{9.81} = 5.14 G$ .

The calculation of the valve spring is carried out as shown in Chapter I, 5, but it should be noted that for crank angles of  $0-5^\circ$  and  $55-60^\circ$ , the inertia, spring pressure and pressure on the valve due to throttling act in the same direction, and are opposed only by the steam pressure on the valve stem area. The friction is assumed to be balanced by the weight. The retardation during the

closing period of the valve must therefore be also calculated by means of tangents, and in order to keep it small, the lifting radius of the cam should be made rather large.

In Fig. 9 is shown a una-flow cylinder with auxiliary exhaust valves placed near the ends of the cylinder barrel, both exhaust and steam valves being of the

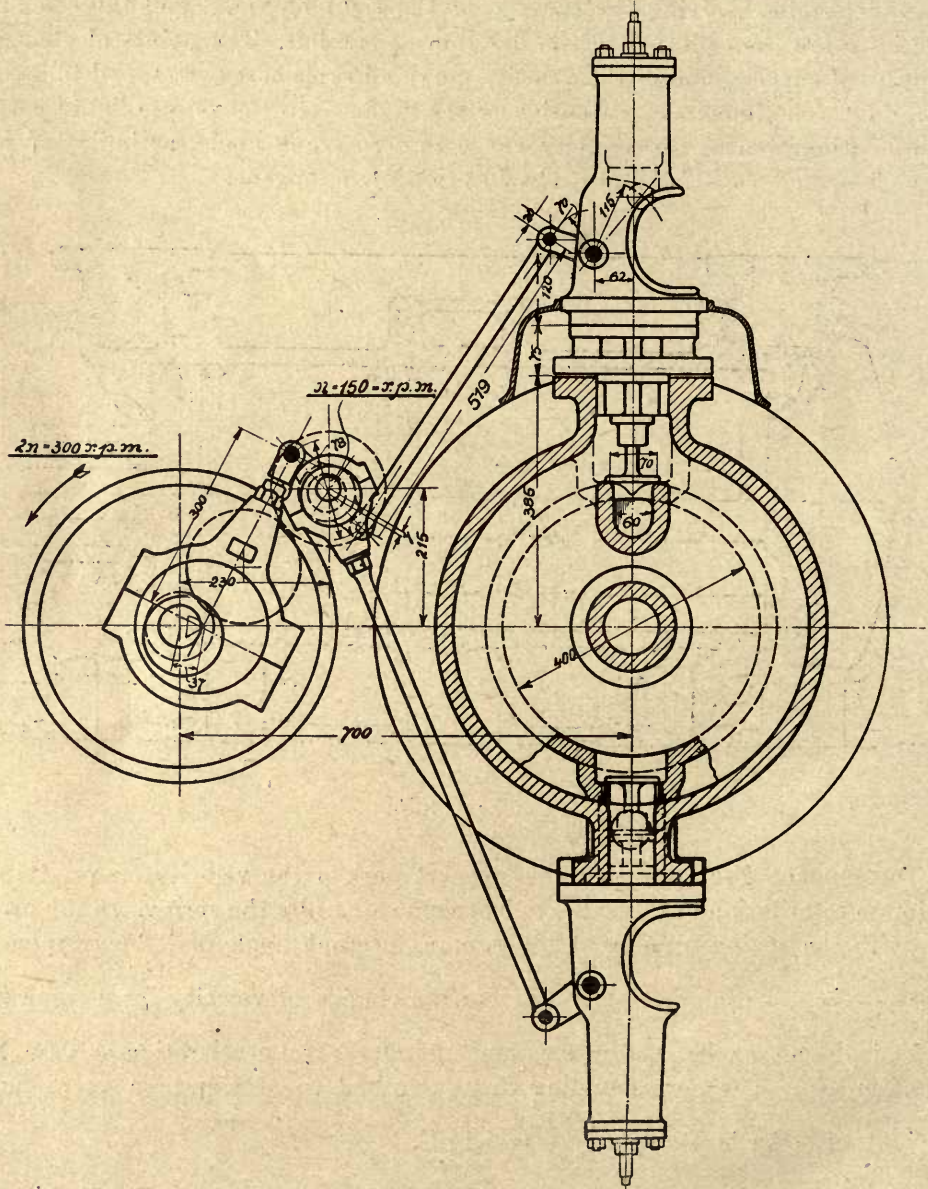


Fig. 10.

single-beat type. The exhaust valves are opened after the steam pressure is relieved by the piston uncovering the main exhaust ports and are closed after the exhaust valve ports are overrun by the piston.



The operation of the auxiliary exhaust valves is thus simplified, and the single-beat form becomes permissible. They may be operated by an eccentric placed 90° ahead of, or behind the main crank. In Fig. 10 the exhaust eccentric is shown mounted on the cut-out shaft, and in Fig. 11 on the main lay shaft, both shafts running at engine

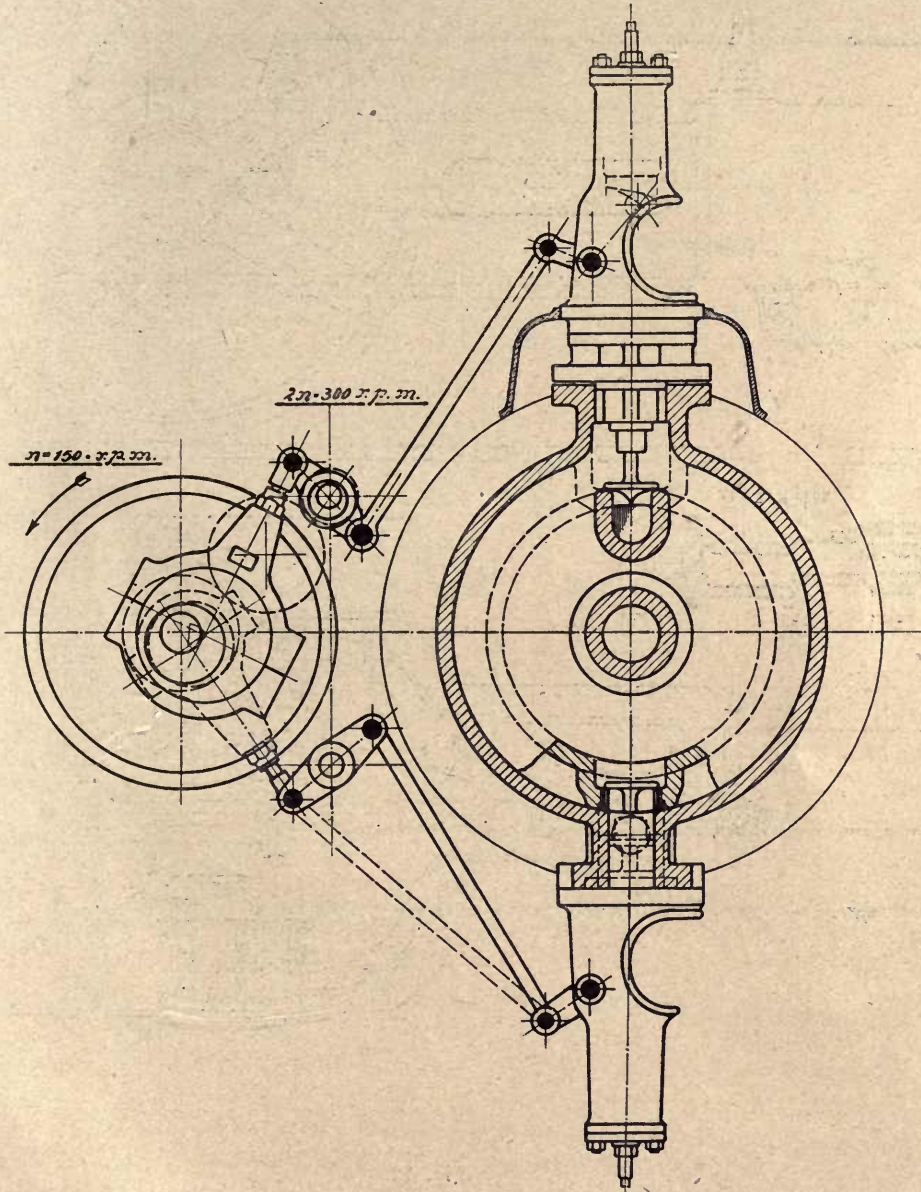


Fig. 11.

speed. The arrangement shown in Fig. 10, with a double-speed lay shaft and single-speed cut-off shaft, will give a range of cut-off up to 35%, while that of Fig. 11, with a single speed lay shaft and double-speed cut-off shaft, has a range up to 70%.

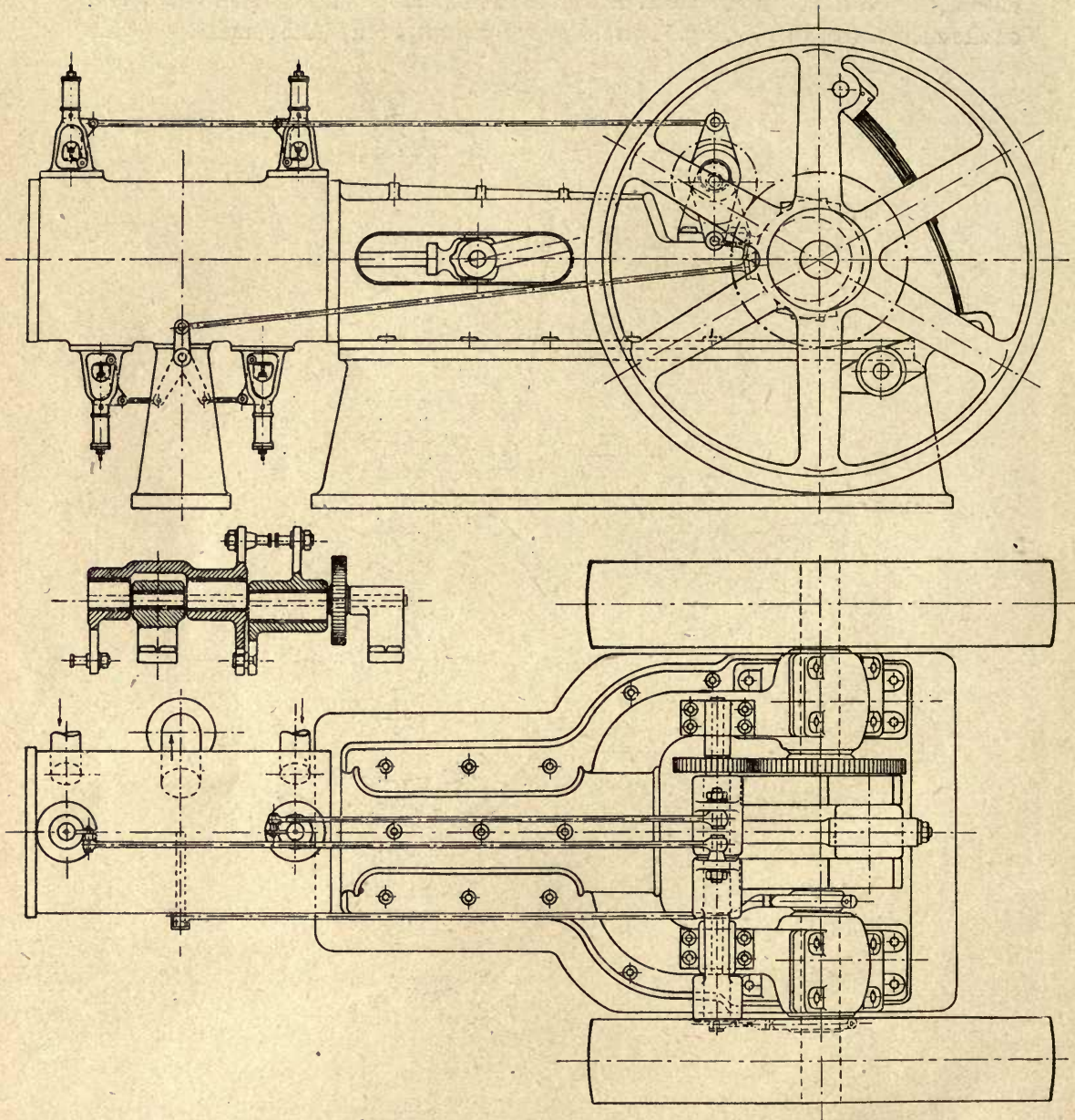


Fig. 12.

An interesting design of the self-contained type is shown in Fig. 12, where the crank shaft is used as lay shaft, the shifting eccentric being controlled by a flywheel governor. The auxiliary eccentric shaft is driven from the crank shaft at double engine speed, by spur gears placed at one side of the crank, while the exhaust eccentric is placed on the other side. The movement of the main eccentric is transmitted to both single-beat inlet valves by rocking levers as previously described, the latter being pivoted on eccentrics at  $180^{\circ}$  on the double-speed shaft, thus magnifying the useful movement. The lower end of the second lever is moved by the lower end of the first one by a pin with bushing and sleeve. The single-beat exhaust valves are operated directly by the exhaust eccentric.

The gear shown in Fig. 11 with its long range of cut-off is suitable for engines intended for ordinary driving purposes, while that shown in Fig. 10, having a more limited range of cut-off, is more useful for those driving pumps and compressors.

## Summary.

At the beginning of this book the different losses of the steam engine were analyzed. The question which arises at the end is, how is the engine to be designed in order to have a minimum total of all these losses? Such an engine in the form of a una-flow engine with single-beat valves is presented in Fig. 6 of Ch. VI, p. 307.

The losses in the steam engine are:

1. Surface loss.
2. Volume loss.
3. Friction loss.
4. Throttling loss.
5. Leakage loss.
6. Loss due to radiation and convection.
7. Loss due to incomplete expansion.

It was demonstrated that the una-flow engine with single-beat valves as shown in Fig. 6 of Chapter VI has the smallest surface loss. In the first place the extent of the harmful surfaces is extremely small. The additional harmful surface consisting of the short and narrow steam inlet passage amounts to only about 5% of the smallest theoretical harmful surface, i. e. twice the area of the cylinder bore. In vertical engines, the additional harmful surface will be still smaller, as is evident from the two and four cylinder single-acting engines shown in Fig. 47, Ch. II, 1, p. 165, and Fig. 31, Ch. V, p. 299. Furthermore, the harmful surfaces may in this case be easily machined and thereby still further reduced. The part of the harmful surface which needs jacketing the most, namely, the area of the cylinder head, is exposed to the heating action of the highly superheated live steam in the best possible manner. The extremely small clearance volume produces a high compression with a terminal compression temperature of about 900° C. The harmful surface is therefore thermally prepared for steam admission in the best possible manner. The surface loss must consequently be very small.

It was also demonstrated that the una-flow engine with single-beat valves has the smallest volume loss. There is no better way to reduce the volume loss than by keeping down the clearance volume to a minimum. The clearance volume of the engine shown in Fig. 6 of Chapter VI is only 1%, which reduces to about  $\frac{3}{4}\%$  for larger engines and to about  $\frac{1}{2}\%$  in the case of the vertical engine with single-beat valves. The long compression also assists in further reducing the volume loss. For these reasons the latter will be extremely small despite the use of single stage expansion. With the small clearance volumes just given, and for the usual range of pressure drop, the critical back pressure of this type of engine, i. e. the

back pressure, below which the steam consumption increases, is far below anything that can be reached with even the best condensing equipment.

It was also shown that the una-flow engine with single-beat valves, assuming the same lubrication and operating conditions, has less friction losses than the equivalent counterflow tandem engine, since there is only one piston instead of two, one piston rod packing instead of three, and two valves instead of eight.

It was proved also that the throttling loss of the una-flow engine with single-beat valves is smaller than that of any other steam engine. In the first place, the throttling losses occurring between the cylinders of multi-stage engines are eliminated altogether. The piston-controlled exhaust permits of a sufficient port area even with very small exhaust lead, so that the pressures between engine cylinder and condenser may equalize fully. The throttling loss at the toe of the diagram is therefore reduced to a minimum, and the indirect loss due to throttling, consisting of a loss of diagram area along the compression line, is eliminated. The early cut-offs employed result in small throttling losses in any case and these are still further reduced by the use of single-beat valves which produce a compact stream instead of the split-up stream of the ordinary double-beat valve, and furthermore permit a fairly correct nozzle diffusor action to be obtained.

It was also shown that the leakage losses of the una-flow engine with single-beat valves must be very small. In the first place the number of points of possible leakage is reduced to a minimum. While on the one hand the ordinary tandem counterflow engine has three piston rod packings, eight valve stems, two piston seals and sixteen valve seats, in the una-flow engine with single-beat valves these are reduced to one piston rod packing, two valve stems, one piston seal and two valve seats. Piston rod stuffing boxes can be made perfectly tight by use of metallic packings of modern design. Similarly, leakage past the valve stems can be completely prevented if they are properly fitted. A self-supporting piston can be made perfectly tight if properly designed, i. e. if the outer rings do not overrun the cylinder bore, if a sufficient number of rings is employed, if they are secured against creeping, and their joints are placed at the lowest point so that the part of the piston in contact with the cylinder wall prevents the steam from reaching the joints. From Fig. 6, Chapter VI, it will also be seen that during the periods of high pressures all six rings are active in forming a seal, and later on when the pressure has fallen appreciably three rings still remain active. Finally the small high-lift single-beat valve (see Fig. 4, Chapter VI) will remain perfectly tight, since its diameter is small, there is only one seat, and the sealing pressure is proportional to the pressure difference. Here the superiority in regard to tightness of the una-flow engine with single-beat valves will find its strongest expression. Last but not least, the series arrangement of live steam space, inlet valve, piston and exhaust is also a very valuable feature of this type of engine. It should therefore be possible to attain complete tightness at all points.

It was shown that the una-flow engine with single-beat valves has the smallest radiation and convection losses.

Since the una-flow engine with single-beat valves possesses the smallest losses due to surface, volume, friction, throttling, leakage and radiation, therefore very small mean effective pressures are theoretically permissible.

It is perfectly clear that the favorable thermal action of the surfaces of the una-flow engine with single-beat valves makes small mean effective pressures economically possible.

Exchanging in rule 7 on page 42 the words "back pressure" and "mean effective pressure", then the rule reads: "*For a given amount of initial pressure, back pressure, clearance volume and length of compression, the mean effective pressure must be chosen in such a way as to make the change of total heat during compression equal to the change of total heat during expansion.*" If now the clearance volume of the una-flow engine with single-beat valves is about 1%, then the terminal compression pressure will very closely approach the initial pressure, and in accordance with the above rule this requires expansion to the back pressure and mean effective pressure equal to zero.

No other type of engine gives such fine, sharp-cornered, no-load cards free from throttling as the una-flow engine with single-beat valves. This type of engine is therefore especially advantageous in cases where long periods of idle running are unavoidable, as for instance in rolling mill engines. The small throttling losses therefore also favor low mean effective pressures.

It is clear without further comment that small friction losses make small mean effective pressures permissible.

Valve leakage in una-flow engines produces a certain increase in terminal pressure at the end of expansion and compression and a corresponding loss in area of the diagram. Piston leakage on the other hand results in a loss of pressure at the end of expansion and compression, also with an equivalent loss of area. Both kinds of losses increase with increasing ratio of expansion or compression, or decreasing mean effective pressure. The perfectly tight steam distributing elements of the una-flow engine with single-beat valves therefore make small mean effective pressures feasible.

It is also obvious that small losses due to radiation and convection permit the use of low mean effective pressures.

Hence the reduction to a minimum of all the six losses so far discussed makes it possible to work with low mean effective pressures. Since a low mean effective pressure is accompanied by a small loss due to incomplete expansion, this leads to the following statement: *The reduction to a minimum of the first six losses has as its consequence a minimum of the seventh loss, i. e. a minimum loss due to incomplete expansion.*

Small mean effective pressures, however, result in larger cylinder dimensions, therefore higher piston loads and higher first cost, the latter to a greater extent than in multi-stage engines. This finally leads to a compromise between the requirements for high economy and low initial cost, i. e. the use of higher mean effective pressures in practice, with a somewhat larger loss due to incomplete expansion, which is on the whole greater than that of multi-stage engines. *In regard to the loss due to incomplete expansion, the una-flow engine with single-beat valves therefore ranks high theoretically, but practical considerations forbid the full realization of this advantage.*

In the chapter on the loss due to incomplete expansion ways and means were indicated by which this loss may be considerably reduced with a simultaneous

increase in the mean effective pressure. This has led to the successful development of the una-flow engine with exhaust ejector action as typified by the una-flow locomotive with single-beat valves, in which the exhaust energy of one cylinder is used to create a vacuum in the second cylinder. This proves that in the case of multi-cylinder una-flow engines the loss due to incomplete expansion may be minimized, and this leaves hope that the same result may also be accomplished for the other kinds of service for which the una-flow engine is so well adapted.

*Finally it may be claimed that in the una-flow engine with single-beat valves and double-speed lay shaft, all the losses are a minimum except that due to incomplete expansion, with the possibility that in the future this loss also may be reduced to a minimum.*

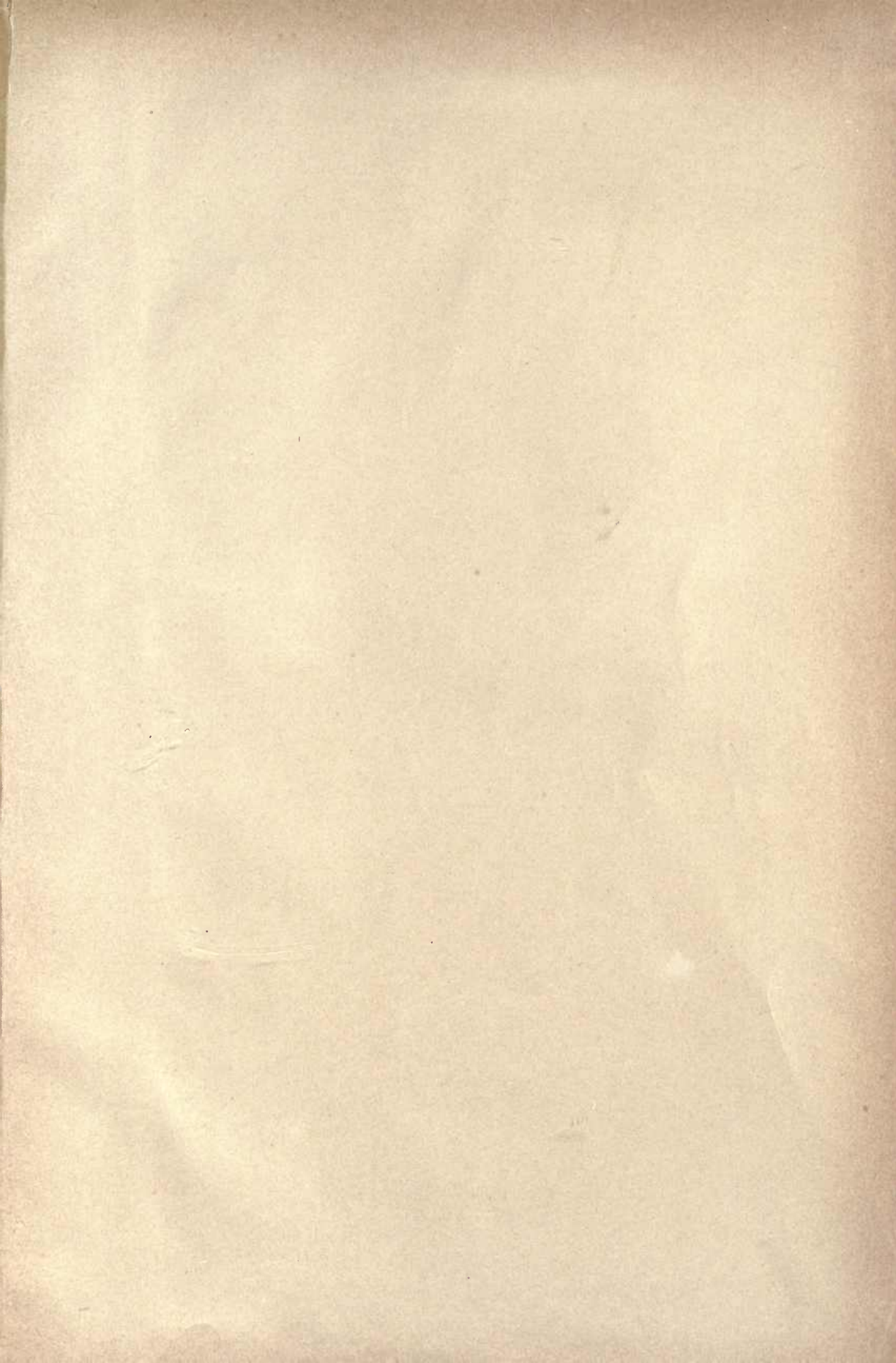
Since the first cost of a una-flow engine is usually 15% lower than that of the equivalent tandem compound engine, it would be correct to reduce the mean effective pressure of the former by such an amount that this difference in first cost is wiped out. In most cases, however, the striving after a reduction in first cost restrains the designer from availing himself of this possibility.

The uni-directional flow, single stage expansion, piston-controlled exhaust and single-beat inlet valves are common features of both the new una-flow steam engine and the two stroke internal combustion engine, while the uni-directional flow is also a feature of the steam turbine. Thus a *certain similarity* is established in the design and performance of the two stroke internal combustion engine and the new una-flow steam engine, thereby proving conclusively that the latter rests upon sound principles.

---











THIS BOOK IS DUE ON THE LAST DATE  
STAMPED BELOW  
AN INITIAL FINE OF 25 CENTS  
WILL BE ASSESSED FOR FAILURE TO RETURN  
THIS BOOK ON THE DATE DUE. THE PENALTY  
WILL INCREASE TO 50 CENTS ON THE FOURTH  
DAY AND TO \$1.00 ON THE SEVENTH DAY  
OVERDUE.

FEB 28 1934

**NOV 17 1977**

~~NOV 17 1977~~

JUL 14 1977

REC'D CIR. JUL 11

FEB 13 1939

INTERLIBRARY LOAN

AUG 18 1980

UNIV. OF CALIF., BERK.

MAR 31 1940

19 Feb '53 HH

FEB 19 1953 HH

*Lassen  
Counts Free  
Lib-*

MAR 25 1988

INTER-LIBRARY  
LOAN

AUTO DEC MAR 22 1988

SENT ON ILL

JUN 19 1970

APR 18 1997

JUN 9 1972 7

U. C. BERKELEY

REC'D LD JUN 1

272-4 PM 2-9

LD 21-100m-7,'33

YE 01149

U.C. BERKELEY LIBRARIES



C006055675

520221

TJ492

S7

1922

UNIVERSITY OF CALIFORNIA LIBRARY

